

Dedham Sign Code COLORING BOOK!

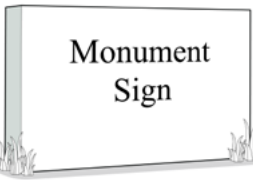

This is a SANDWICHBOARD SIGN. It is a temporary type of sign that business sometimes put on the sidewalk to advertise specials or sales.

What special would you feature on your menu?

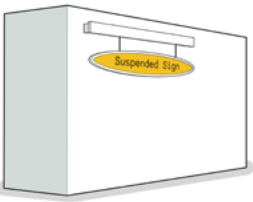
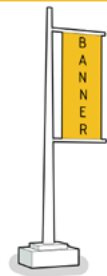
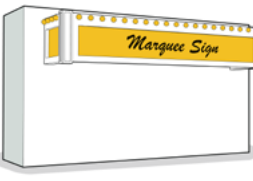
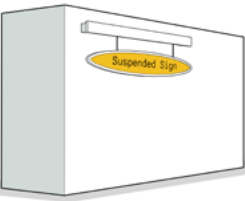
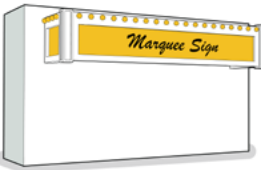
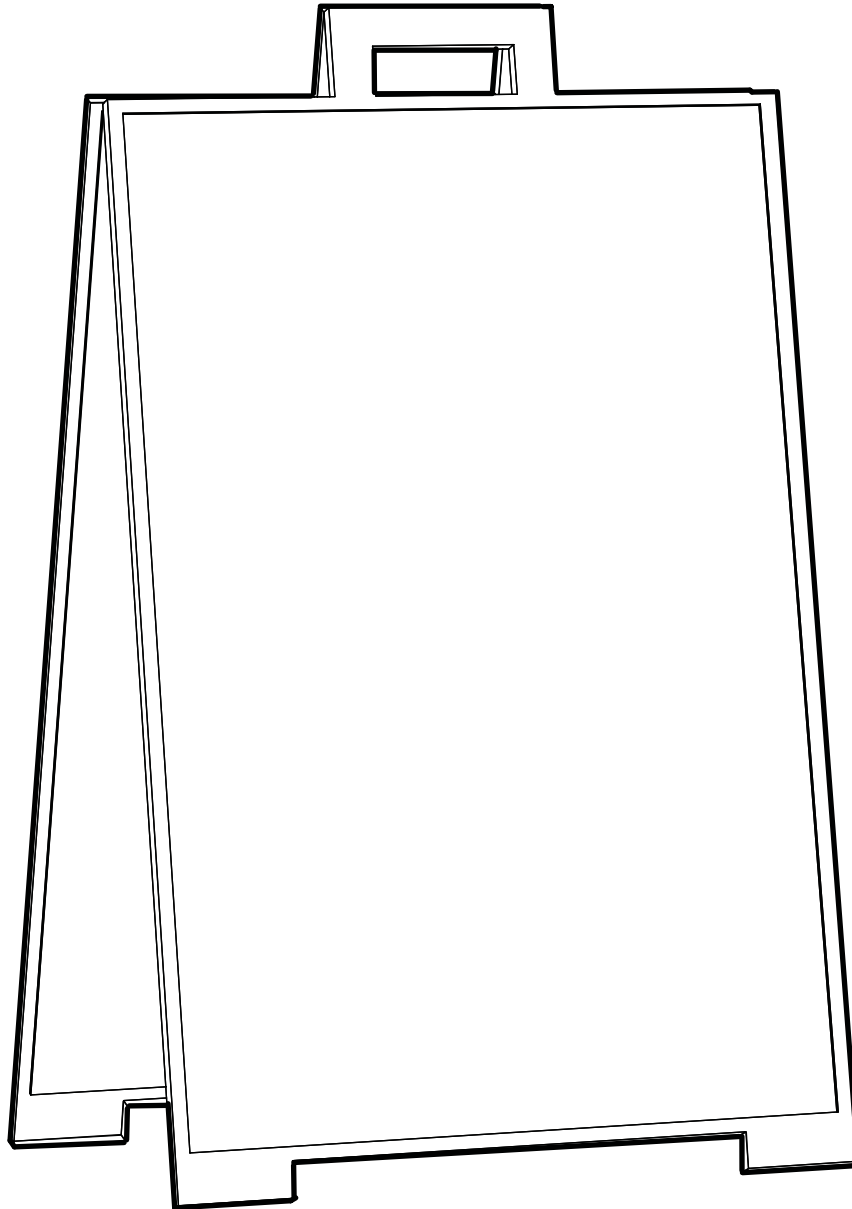

*To enter your drawing in a raffle for a chance to **win 1 of (5) \$50 Visa Gift Cards**, please provide your name and preferred contact information so that we can get in touch with you if you win!*

Name: _____

Contact Info: _____

This is a MARQUEE SIGN. It is usually seen at theaters.

Which movies or plays would you advertise on this marquee sign?

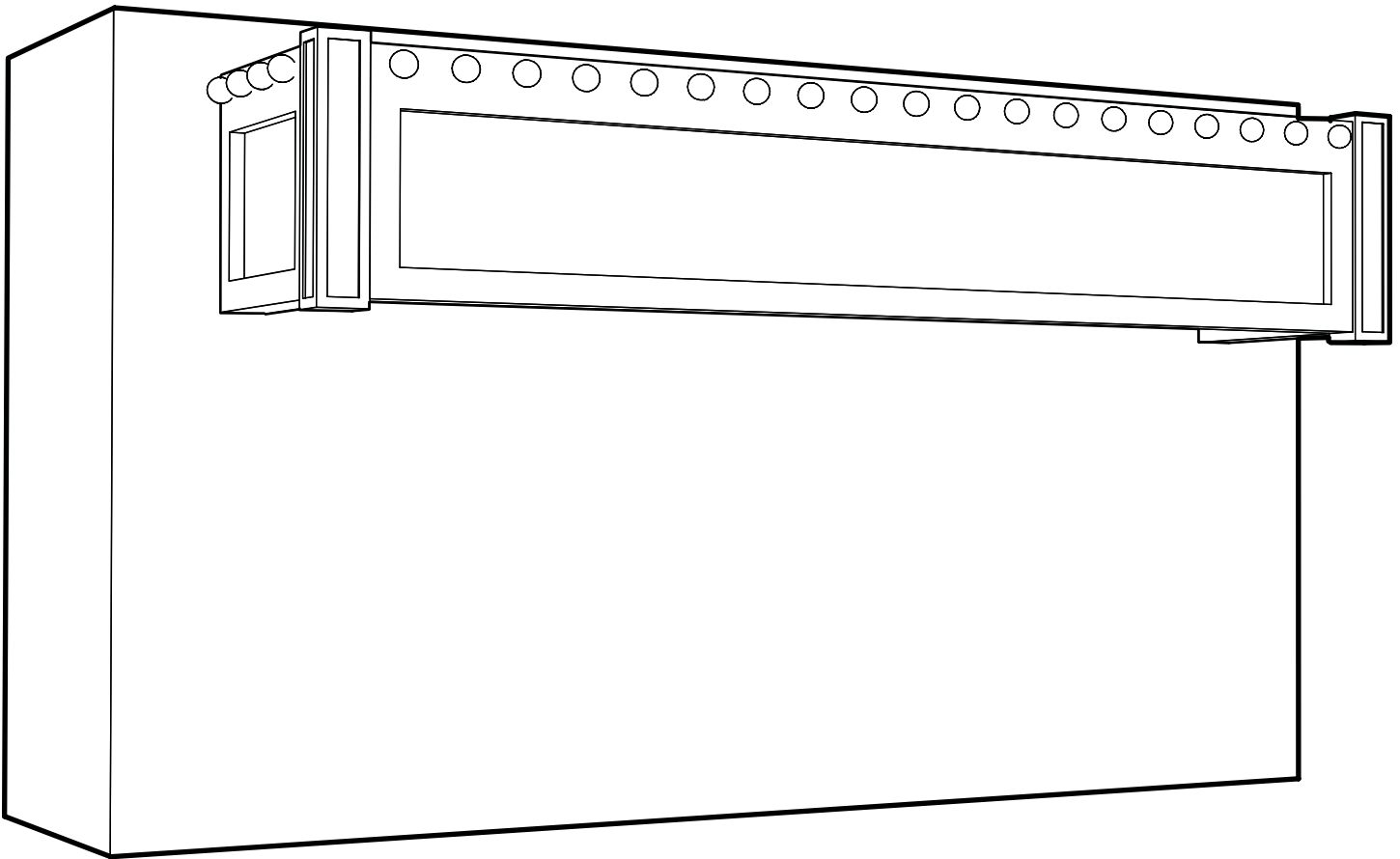

*To enter your drawing in a raffle for a chance to **win 1 of (5) \$50 Visa Gift Cards**, please provide your name and preferred contact information so that we can get in touch with you if you win!*

Name: _____

Contact Info: _____

This is a BANNER. They are sometimes put out to advertise an event or a holiday.

Can you design a banner to celebrate your favorite occasion?

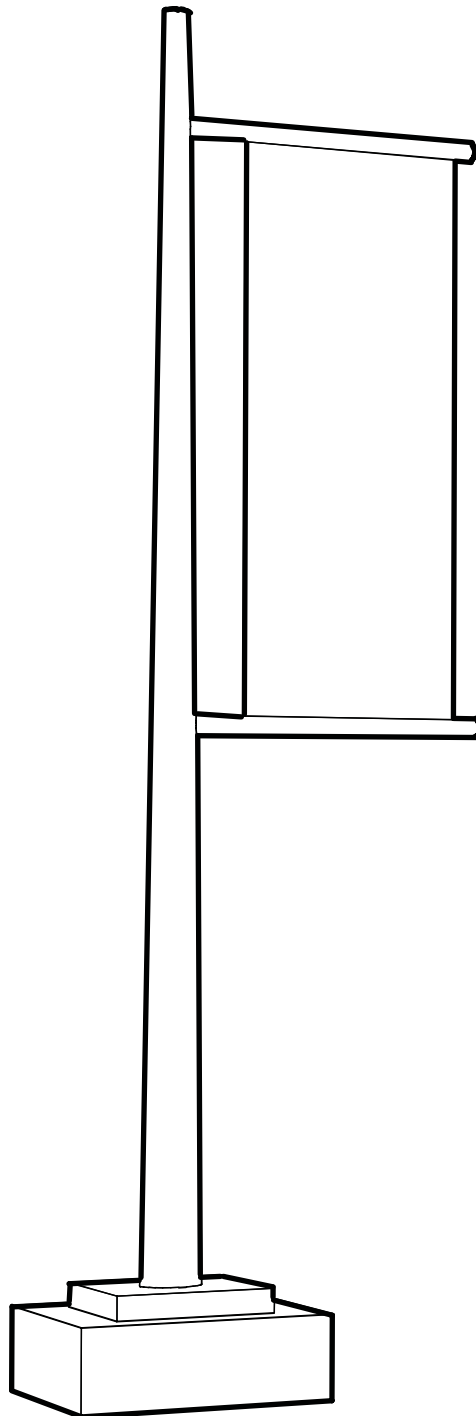

*To enter your drawing in a raffle for a chance to **win 1 of (5) \$50 Visa Gift Cards**, please provide your name and preferred contact information so that we can get in touch with you if you win!*

Name: _____

Contact Info: _____

This is a PROJECTING SIGN. This is a sign that sticks out from the building it is attached to.

What type of business would you advertise on this sign?

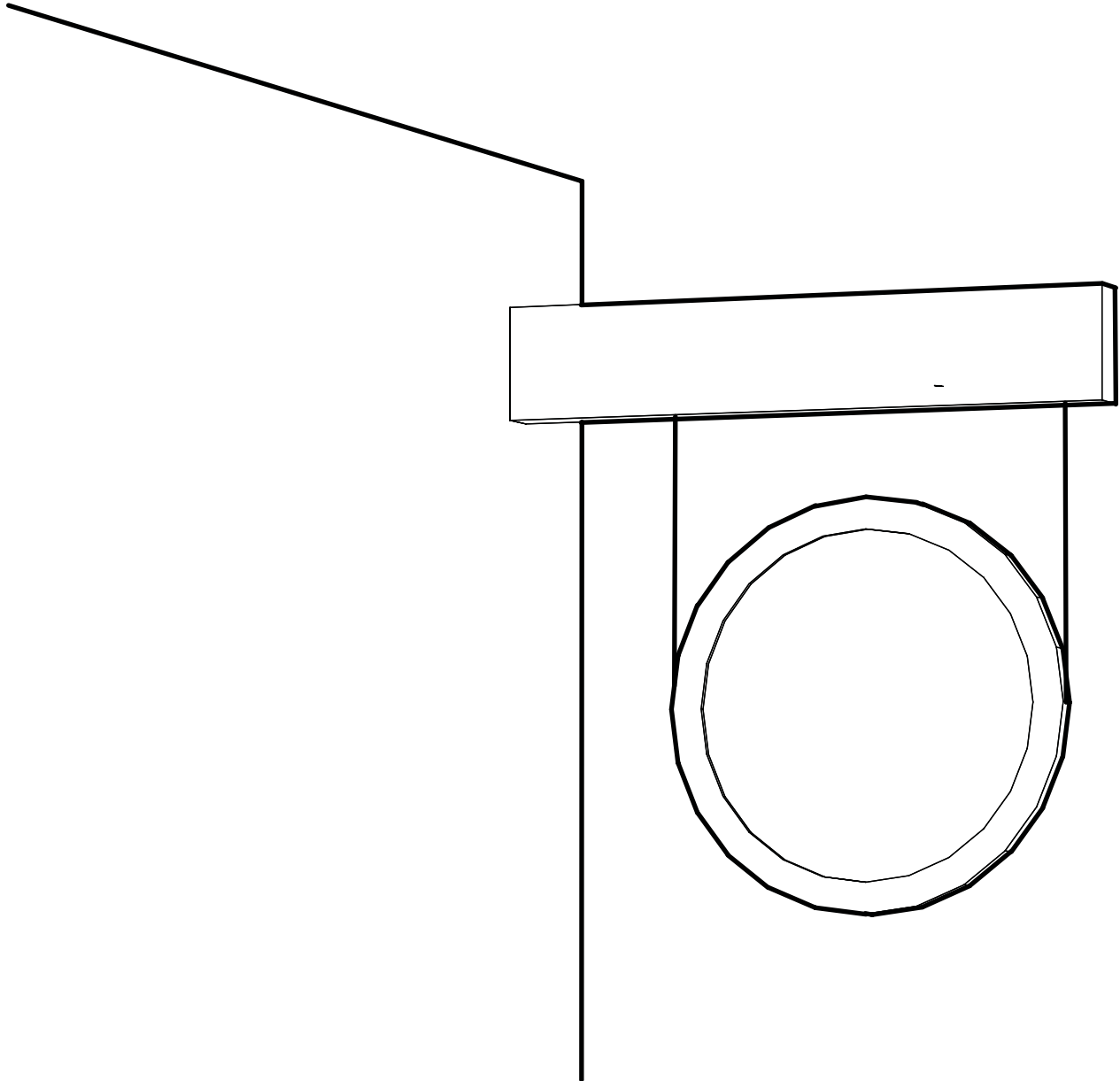

*To enter your drawing in a raffle for a chance to **win 1 of (5) \$50 Visa Gift Cards**, please provide your name and preferred contact information so that we can get in touch with you if you win!*

Name: _____

Contact Info: _____

This is a DIGITAL DISPLAY SIGN. You've probably seen them next to the road reminding you to buckle your seatbelt!

What message do you think people should see?

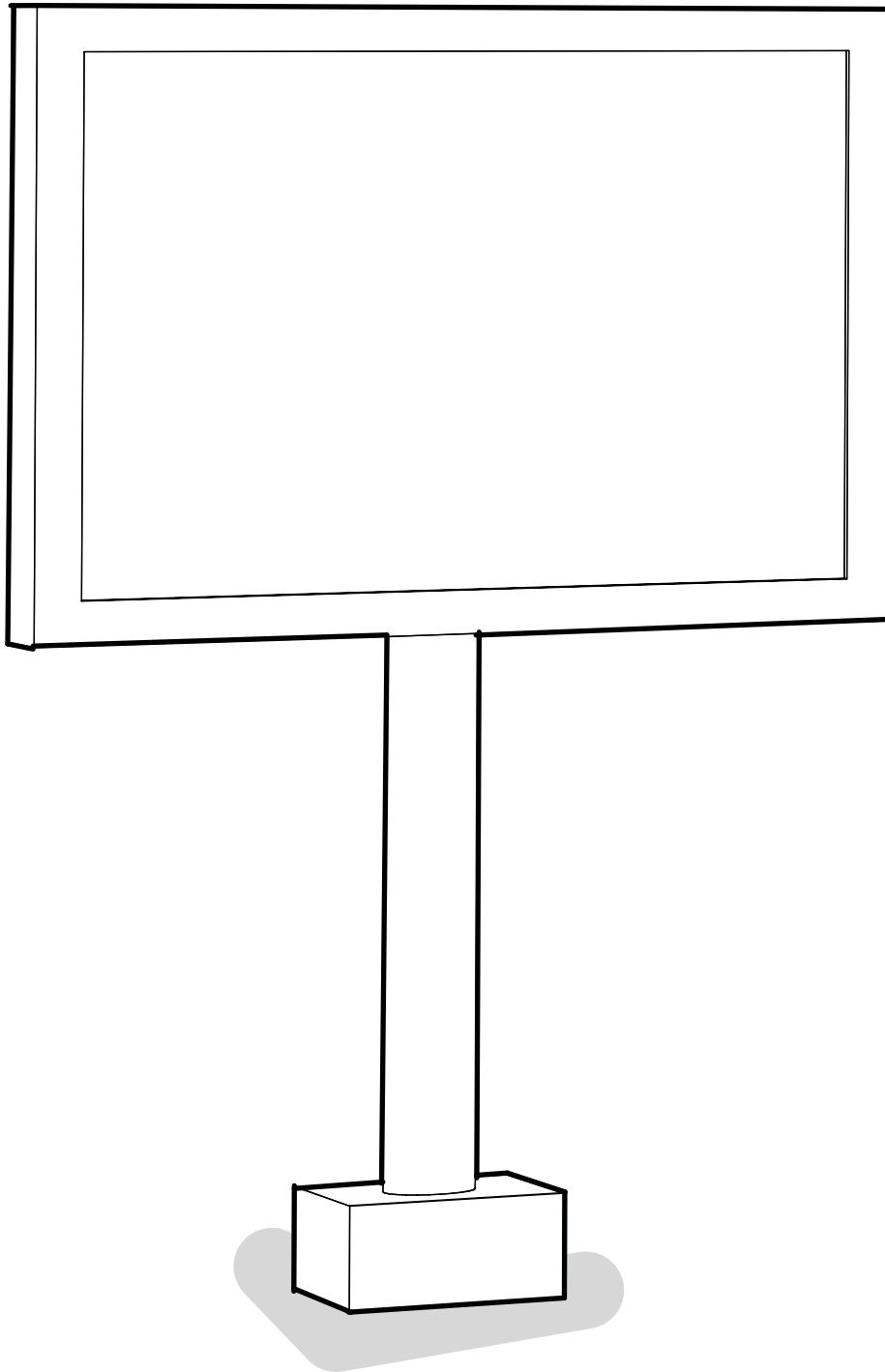

*To enter your drawing in a raffle for a chance to **win 1 of (5) \$50 Visa Gift Cards**, please provide your name and preferred contact information so that we can get in touch with you if you win!*

Name: _____

Contact Info: _____

A MURAL is a large painted artwork (that sometimes doubles as a sign) that usually takes up an entire wall of a building!
What kind of mural would you paint on this wall?

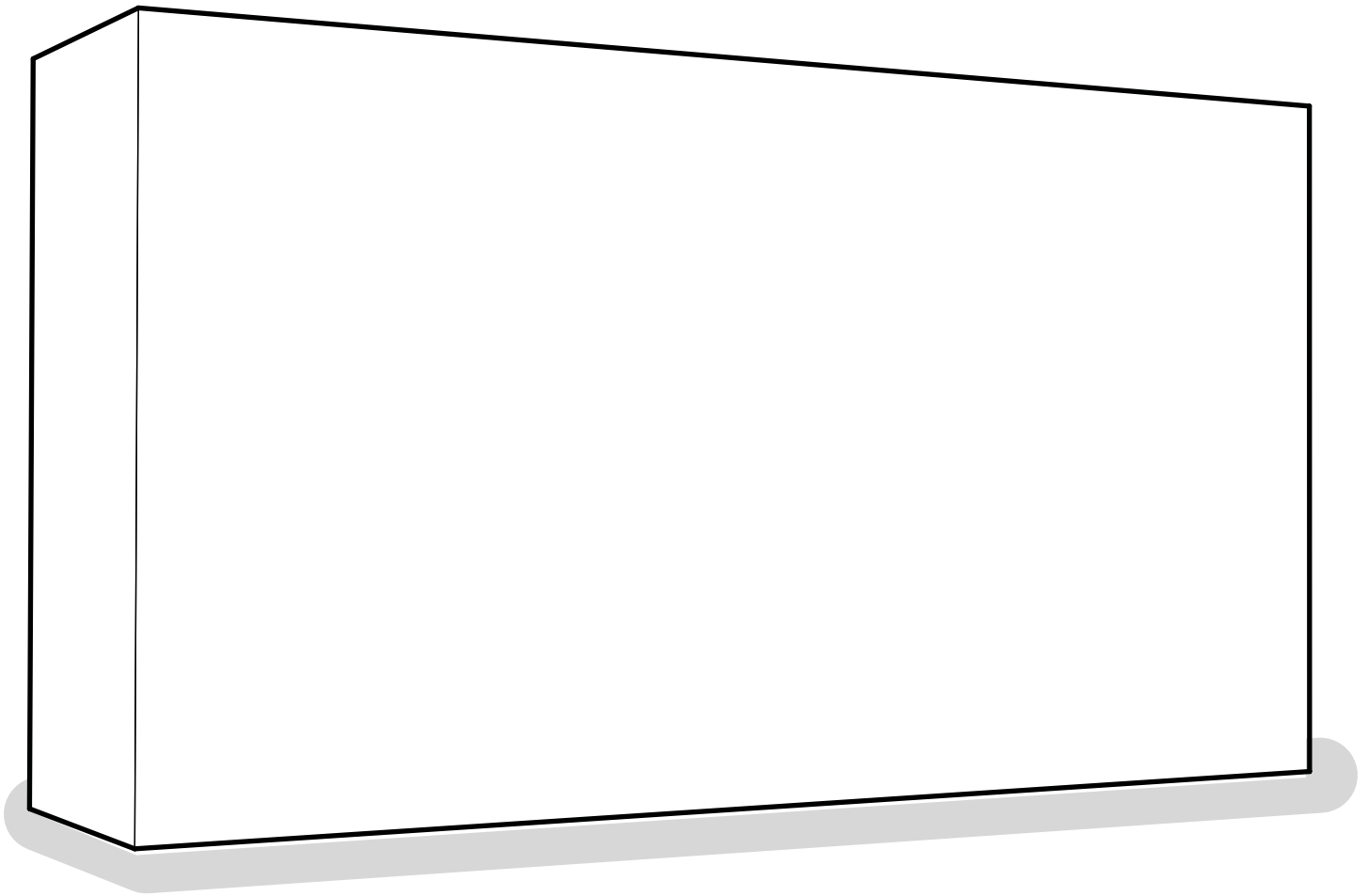

*To enter your drawing in a raffle for a chance to **win 1 of (5) \$50 Visa Gift Cards**, please provide your name and preferred contact information so that we can get in touch with you if you win!*

Name: _____

Contact Info: _____