

Contract No. _____

TOWN OF DEDHAM, MASSACHUSETTS
CONTRACT DOCUMENTS
FOR

2021 SEWER ON-CALL SERVICES



January 2021

Town of Dedham
Department of Infrastructure Engineering

Leon Goodwin, Town Manager
Jason L. Mammone, P.E., Director of Engineering
Joseph Flanagan, Director of Public Works

TABLE OF CONTENTS

	<u>Section Number</u>
1 <u>BIDDING AND CONTRACT REQUIREMENTS</u>	
Invitation to Bid	00020
Instructions to Bidders	00100
Bid Form	00300
Agreement	00500
Construction Performance Bond	00610
Construction Payment Bond	00620
Certificates of Insurance	00650
General Conditions	00700
Supplemental General Conditions	00800
Excerpts from Applicable State Law	00850
Permits	00890
Attachment A – Wage Rates and Certificate of Compliance	
Attachment B - (MBE/EEO/AA)	
1 <u>GENERAL REQUIREMENTS</u>	
Scope and Sequence of Work	01014
Control of Work & Materials	01110
Special Provisions	01140
Measurement & Payment	01270
Submittals	01330
Documentation	01331
Health & Safety Plan	01380
Signage	01550
Construction Zone Safety Plan	01552
Environmental Protection	01570
Handling Existing Flows	01575
Cleaning Up	01740
2 <u>SITE WORK</u>	
Clearing & Grubbing	02230
Cured-in-Place Pipe	02428
Cured-in-Place Short Liner	02429
Sewer Manhole Rehabilitation	02435
Sewer Line and Manhole Chemical Root Treatment	02435
Sewer Cleaning and Television Inspection	02440
Uniformed Officers for Traffic Control	02451
Service Connection Rehabilitation	02453

Attachments: Plans – “2021 Sewer Rehab Maps”
Work Tables
Manhole Rehabilitation Detail

SECTION 00020

INVITATION FOR BIDS

Sealed bids for furnishing the following item(s) will be received at the Department of Public Works at 55 River Street, Dedham, MA 02026 until the time specified below at which time the proposals will be publicly opened and read:

	<u>ITEM</u>	<u>BID OPENING</u>
Bid:	2021 Sewer On-Call Services	February 4, 2021

The scope of work under this contract includes the emergency cleaning of sewers (24-hours a day) based on an hourly rate, the cleaning and inspection of sewers based on an hourly rate, the wet weather cleaning and television inspection of sewers ranging in pipe diameter from 4-inch to 36-inch, structural short liners, structural line pipe (cured-in-place), rehabilitation (external chemical grouting and internal cementitious lining) of sewer manholes and chemical root treatment. The contract is in the Town of Dedham, Massachusetts.

The Contractor must have the capability to respond to a request to perform work within 2-hours' notice (24-hours per day) for emergency cleaning, and the capability to respond to a request to perform work within 10 consecutive calendar days outside of emergency cleaning. Wet weather cleaning and television inspection work shall be performed between March 1st – May 31st and the contractor must have the ability to perform the quantity of work included in the contract during that time period. The Contractor is cautioned that under this contract there is no guarantee of consistent workload volume throughout the length of the Contract.

The term of this contract shall extend from March 1, 2021 through December 31, 2021. The Town, at its sole direction, shall have the option to extend for one (1) additional year period, January 1, 2022 through December 31, 2022, with no changes in the contract price or terms and conditions, and at its sole direction with consent of the contractor, the option to extend for an additional one (1) year period, January 1, 2023 through December 31, 2023.

Specifications, bid forms and plans may be obtained at the Engineering Department Office located at the Department of Public Works facility, 55 River Street, Dedham, MA, after January 13, 2021 between 8:00 A.M. and 2:00 P.M, upon a nonrefundable payment of \$50.00. This amount is not refundable. Cash is not acceptable. Checks shall be made payable to the Town of Dedham.

Bidders may also obtain a PDF version of the specifications (including all Attachments) from the Town of Dedham's website <https://www.dedham-ma.gov/departments/engineering/invitation-for-bids-proposals> at no charge.

Bids will be opened in the Department of Public Works facility, 55 River Street, Dedham, MA 02026, at 10:00 AM. Bid openings will not be open to the public, however the bid opening will be available through video conference using Zoom. Zoom can be downloaded for free at

www.zoom.us to access video conferencing, or the conference can be joined by audio only without the use or need of the Zoom application at all. All pertinent information for the Zoom video conference is shown below:

Topic: 2021 Sewer On-Call Services Contract - Bid Opening
Time: Feb 4, 2021 10:00 AM Eastern Time (US and Canada)

Join Zoom Meeting: <https://zoom.us/j/5274574085>

Meeting ID: 527 457 4085

One tap mobile

+13126266799,,5274574085# US (Chicago)

+16465588656,,5274574085# US (New York)

Dial by your location

+1 312 626 6799 US (Chicago)

+1 646 558 8656 US (New York)

+1 301 715 8592 US (Washington D.C)

+1 346 248 7799 US (Houston)

+1 669 900 9128 US (San Jose)

+1 253 215 8782 US (Tacoma)

Meeting ID: 527 457 4085

Find your local number: <https://zoom.us/u/aeme38RKA>

Bid opening will be recorded and available on the Town of Dedham website following the bid opening. Each Bid must be accompanied by a bid security consisting of a BID BOND, CASH, or, CERTIFIED CHECK issued by a responsible bank or trust company in the amount of 5% of the bid price.

A performance bond in an amount equal to 100 percent of the total amount of the bid with a surety company qualified to do business in the Commonwealth of Massachusetts will be required for the faithful performance of the contract as well as a labor and materials bond in an amount equal to 100 percent of the total bid amount.

All bids for this project are subject to applicable public bidding laws of Massachusetts, including **G.L. c.30, §39M** as amended.

Attention is directed to the minimum wage rates to be paid as determined by the Commissioner of Labor and Industries under the provisions of Massachusetts General Laws, Chapter 149, Section 26 to 27D inclusive.

Selection of the contractor will be based upon bidder qualifications, including evidence of past performance in similar projects, and bid price. The contract will be awarded to the bidder deemed by the awarding authority to be the lowest responsible and eligible bidder for each contract.

The Town of Dedham is an affirmative action/equal opportunity owner/purchaser.
The bidder agrees that its bid shall be good and may not be withdrawn for a period of 30 days, Saturdays, Sundays and legal holidays excluded, after the opening of the bids.

The Town reserves the right to waive any informalities, to accept or reject, in whole or in part any or all bids, or take whatever other action may be deemed to be in the best interest of the Town.

The Town of Dedham, Massachusetts

By Leon Goodwin

Its Town Manager

SECTION 00100

INSTRUCTIONS TO BIDDERS

1. Receipt and Opening of Bids
2. Location of Work to be Done
3. Deposit on Documents
4. Preparation of Work
5. Bid Opening Procedure
6. Telegraphic Modification
7. Ability and Experience of Bidder
8. Conditions of Work
9. Addenda and Interpretations
10. Security for Faithful Performance
12. Power of Attorney
13. Laws and Regulations
14. Liquidated Damages for Failure to Enter into Contract
15. Obligation of Bidder
16. Information Not Guaranteed
17. Bid Security
18. Right to Reject Bid
19. Time for Completion
20. Comparison of Bids
21. Award of Contract
22. Statutes Regulating Competitive Bidding
23. Wage Rates
24. Contractor Records
25. Insurance
26. Affirmative Action/Equal Employment Opportunity Laws and Regulations

1. Receipt and Opening of Bids

The Town of Dedham, Massachusetts, herein called the Owner, acting by and through its Town Manager, will receive sealed Bids for the 2021 Sewer On-Call Services.

Such bids addressed to the Engineering Department, 55 River Street, Dedham, MA 02026, and endorsed BID for the 2021 Sewer On-Call Services Contract will be received at the Engineering Department office, located at the Department of Public Works facility, 55 River Street, Dedham, MA, 02026 until 10:00 AM prevailing time, on Thursday, February 4, 2021 at which time and place said bids will be opened and read aloud. The DPW facility is currently closed to the public, sealed bids that are sent via an independent courier (i.e. FedEx, UPS, etc.) should not require a signature, bids shall be placed in the mailbox located at the front door of the DPW facility. Bid opening will not be open to the public, however the bid opening will be available on the Town of Dedham website following the bid opening.

Any bid may be withdrawn prior to the above scheduled time for the opening of bids or authorized postponement thereof. Any bid received after the time and date specified will not be considered. The bidder agrees that this bid shall be good and may not be withdrawn for a period of 30 days, Saturdays, Sundays, and legal holidays excluded, after the opening of bids.

2. Location and Work to be Done

The scope of work under this contract includes the emergency cleaning of sewers (24-hours a day) based on an hourly rate, the cleaning and inspection of sewers based on an hourly rate, the wet weather cleaning and television inspection of sewers ranging in pipe diameter from 4-inch to 36-inch, structural short liners, structural line pipe (cured-in-place), rehabilitation (external chemical grouting and internal cementitious lining) of sewer manholes and chemical root treatment. The contract is in the Town of Dedham, Massachusetts.

The Contractor must have the capability to respond to a request to perform work within 2-hours' notice (24-hours per day) for emergency cleaning, and the capability to respond to a request to perform work within 10 consecutive calendar days outside of emergency cleaning. Wet weather cleaning and television inspection work shall be performed between March 1st – May 31st and the contractor must have the ability to perform the quantity of work included in the contract during that time period. The Contractor is cautioned that under this contract there is no guarantee of consistent workload volume throughout the length of the Contract.

The term of this contract shall extend from March 1, 2021 through December 31, 2021. The Town, at its sole direction, shall have the option to extend for one (1) additional year period, January 1, 2022 through December 31, 2022, with no changes in the contract price or terms and conditions, and at its sole direction with consent of the contractor, the option to extend for an additional one (1) year period, January 1, 2023 through December 31, 2023.

The location, general characteristics, and principal details of the work in the form of maps, drawings and worksheets are attached. The exact location and work to be done are shown for information only and are subject to modifications, deletions, and additions as deemed necessary by the Owner.

The Contractor shall furnish all labor, services, materials, equipment, plant, machinery, apparatus, appliances, tools, supplies, and all other things necessary to do all work required for the completion of each item of the Work and as herein specified.

The work to be done and paid for under any item shall not be limited to the exact extent mentioned or described but shall include all incidental work necessary or customarily done for the completion of that item.

3. Deposit on Documents

A deposit, in the amount as specified in Section 00020, Invitation for Bids, in check payable to the Town of Dedham will be required on each set of Contract Documents taken. Such deposits are non-refundable. Cash is not acceptable.

4. Preparation of Bid

Each bid must be submitted on the prescribed form. All blank spaces for bid prices must be filled in, in ink or typewritten, in both words and figures. Each bid must be submitted in a sealed envelope bearing on the outside the name of the bidder, his address, and endorsed with the name of the project as specified in Receipt and Opening of Bids, above.

If forwarded by mail, the sealed envelope containing the bid must be enclosed in another envelope addressed as specified in Receipt and Opening of Bids, above.

5. Bid Opening Procedure

The following list of requirements shall apply to each filed bid. Bids not meeting all the requirements for timeliness and security will be rejected without opening; bids not meeting signature and addenda requirements will be rejected prior to checking of bid amounts.

Bids shall be filed at the place and before the time specified in Receipt and Opening of Bids, above.

Properly executed bid security shall be placed in a sealed envelope and shall be attached to the outside of the envelope containing the bid.

Bid signatures will be checked.

All addenda, including a mechanism to confirm receipt, shall be issued by the Town by any means deemed suitable to the Town to all bidders no later than five days prior to the date established for the submission of bids. All bidders shall include with their bids the written acknowledgement form provided in Section 00300, FORM OF GENERAL BID. Failure of any bidder to receive any such addendum or interpretation shall not relieve such bidder from any obligation under his bid as submitted.

The total dollar amount of each bid will be read, and the three apparent lowest bids will be selected for further consideration. These three apparent low bids will be read aloud for the benefit of the other bidders and the bid opening procedure will be closed. All those present at the bid opening may examine all bids after the bid opening and after the reading of the three apparent low bids.

6. Telegraphic Modification

Any bidder may modify his bid by telegraphic communication at any time prior to the scheduled closing time for receipt of bids, provided such telegraphic communication is received by the Owner prior to the closing time, and, provided further, the Owner is satisfied that a written confirmation of the telegraphic modification over the signature of the bidder was mailed prior to the closing time.

The telegraphic communication shall not reveal the bid price but shall provide the addition or subtraction or other modification so that the final prices or terms will not be known by the Owner until the sealed bid is opened. If written confirmation is not received within two days from the closing time, no consideration will be given to the telegraphic communication.

7. Ability and Experience of Bidder

No award will be made to any bidder who cannot satisfy the Owner that he has sufficient ability and experience in this class of work and sufficient capital and plant to enable him to prosecute and complete the work successfully within the time named. The Owner's decision or judgment on these matters will be final, conclusive, and binding.

The Owner may make such investigations as he deems necessary, and the bidder shall furnish to the Owner, under oath if so required, all such information and data for this purpose as the Owner may request.

8. Conditions of Work

Each bidder must familiarize himself fully with the conditions relating to the construction of the project and the employment of labor thereon. Failure to do so will not relieve a successful bidder of his obligation to furnish all material and labor necessary to carry out the provisions of his contract. Insofar as possible the Contractor, in carrying out his work, must employ such methods or means as will not cause any interruption of or interference with the work of any other Contractor.

9. Addenda and Interpretations

No interpretation of the meaning of the plans, specifications or other prebid documents will be made to any bidder orally. All information given to bidders other than by means of the plans, specifications, or by addenda, as described below, is given informally and shall not be used as the basis of a claim against the Owner.

Every request for such interpretation should be in writing addressed to the Director of Engineering, 55 River Street, Dedham, MA 02026, and to be given consideration must be received at least seven days prior to the date fixed for the opening of bids. Any and all such interpretations and any supplemental instructions will be in the form of a written addenda to the specifications and issued as described above in Part 5, "Bid Opening Procedure". Failure of any bidder to receive any such addendum or interpretation shall

not relieve such bidder from any obligation under his bid as submitted. All addenda so issued shall become part of the Contract Documents.

10. Security for Faithful Performance

Simultaneously with his delivery of the executed Contract, the Contractor shall furnish a surety bond or bonds as security for faithful performance of this contract and for the payment of all persons performing labor and materials under this contract as specified in Section 00700, GENERAL CONDITIONS included herein. The surety on such bond or bonds shall be a surety company qualified to do business under the laws of the Commonwealth and satisfactory to the Owner. The bonds shall remain in force for one year after final acceptance of the work by the Owner, unless the Owner, in writing, releases the Contractor from the obligation sooner.

11. Power of Attorney

Attorneys-in-fact who sign Contract bonds must file with each bond a certified and effectively dated copy of their power of attorney.

12. Laws and Regulations

The bidder's attention is directed to the fact that all applicable State laws, municipal ordinances, and the rules and regulations of all authorities having jurisdiction over construction of the project shall apply to the contract throughout, and they will be deemed to be included in the Contract the same as though herein written out in full. Attention is directed to Section 00850 and to other applicable sections of this specification.

13. Liquidated Damages for Failure to Enter into Contract

The successful bidder, upon his failure or refusal to execute and deliver the Contract and bonds required within 10 days after he/she has received notice of the acceptance of his/her bid, shall forfeit to the Owner, as liquidated damages for such failure or refusal, a portion of security deposited with his/her bid, but the amount forfeited shall not exceed the difference between his/her bid price and the bid price of the next lowest responsible and eligible bidder. In case of death, disability, bonafide clerical or mechanical error of a substantial nature, or other similar unforeseen circumstances affecting the bidder, his/her bid deposit will be returned.

14. Obligation of Bidder

At the time of the opening of bids each bidder will be presumed to have inspected the site and to have read and to be thoroughly familiar with the Contract Documents (including all addenda). The failure or omission of any bidder to examine any form, instrument, or document shall in no way relieve any bidder from any obligation in respect of his bid.

15. Information Not Guaranteed

All information given in the Contract Documents relating to subsurface and other conditions, natural phenomena, existing pipes, and other structures is from the best sources at present available to the Owner. All such information is furnished only for the information and convenience of bidders and is not guaranteed.

It is agreed and understood that the Owner does not warrant or guarantee that the subsurface or other conditions, natural phenomena, existing pipes, or other structures encountered during construction will be the same as those indicated in the Contract Documents.

It is further agreed and understood that no bidder or Contractor shall use or be entitled to use any of the information made available to him or obtained in any examination made by him in any manner as a basis of or ground for any claim or demand against the Owner or the Engineer, arising from or by reason of any variance which may exist between the information made available and the actual subsurface or other structures actually encountered during the construction work, except as may otherwise be expressly provided for in the Contract Documents.

16. Bid Security

Each bid must be accompanied by a certified check, a bid bond, cash, a treasurer's or cashier's check, payable to the Owner, in the amount stated in Section 00020, INVITATION TO BID. Such checks will be returned to all except the three lowest responsible and eligible bidders within five days, Saturdays, Sundays, and legal holidays excluded, after the opening of bids, and the remaining checks will be returned promptly after the Owner and the accepted bidder have executed the Contract, or if no notice of intent to award has been presented to the selected contractor within 30 days, Saturdays, Sundays and holidays excluded, after the date of the opening of bids, upon demand of the bidder at any time thereafter.

17. Right to Reject Bid

The Owner reserves the right to waive any informalities or reject any and all bids, should the Owner deem it to be in the public interest to do so.

The Owner may also reject bids which in its sole judgment are either incomplete, conditional, obscure or not responsive or which contain additions not called for, erasures not properly initialed, alterations, or similar irregularities, or the Owner may waive such omissions, conditions or irregularities.

The Owner also reserves the right to reject the bid of any bidder that the Owner considers to be unqualified based on the criteria set forth in Article 20 herein.

18. Time for Completion

The bidder must agree to commence work within ten (10) days of the date of the Notice to Proceed and to fully complete the project within the time limit stated in Section 00300, FORM OF GENERAL BID.

19. Comparison of Bids

Bids will be compared on the basis of the quantities and unit and lump sum prices set forth in the bid forms.

In the event that there is a discrepancy in Section 00300, FORM OF GENERAL BID between the lump sum or unit prices written in words and figures, the prices written in words will govern.

The Owner agrees to examine and consider each FORM OF GENERAL BID submitted in consideration of the qualifications of the bidder and the bidder's agreements, as hereinabove set forth and as set forth in Section 00300, FORM OF GENERAL BID.

20. Award of Contract

The Contract will be awarded to "the lowest responsible and eligible bidder" pursuant to General Laws Chapter 30, Section 39M, as amended. Such a bidder shall possess the skill, ability and integrity necessary for the faithful performance of the work, shall be able to furnish labor that can work in harmony with all other elements of labor employed, or to be employed, in the work, and shall otherwise comply with all applicable provisions of law.

The Contractor must have the capability to respond to a request to perform work within 2-hours' notice (24-hours per day) for emergency cleaning, and the capability to respond to a request to perform work within 10 consecutive calendar days outside of emergency cleaning. Wet weather cleaning and television inspection work shall be performed between March 1st – May 31st and the contractor must have the ability to perform the quantity of work included in the contract during that time period. The Contractor is cautioned that under this contract there is no guarantee of consistent workload volume throughout the length of the Contract.

The term of this contract shall extend from March 1, 2021 through December 31, 2021.

Notwithstanding the paragraphs above, the Town reserves the right to award a single contract to the lowest responsible and eligible bidder for all five contracts, if the total bid price of all five contracts varies by less than 10% of the lowest bid price for each contract.

21. Statutes Regulating Competitive Bidding

Any bid which does not comply with the provisions of Massachusetts General Laws Chapter 30, Section 39M as amended, need not be accepted and the Owner may reject every such bid.

22 Wage Rates

Prevailing Wage Rates as determined by the Commissioner of Department of Labor and Industries under the provision of the Massachusetts General Laws, Chapter 149, Section 26 to 27G, as amended, apply to this project. It is the responsibility of the contractor, before bid opening, to request if necessary, any additional information on Prevailing Wage Rates for those tradespeople who may be employed for the proposed work under this contract.

State schedules of Prevailing wage rates are included in the Supplemental General Conditions section of the contract documents.

23 Contractor Records

The Contractor shall comply with the provisions of Massachusetts General Laws, Chapter 30, Section 39R, concerning Contractor records.

24 Insurance

The Contractor shall carry and continuously maintain until completion of the Contract, insurance as specified in the Supplemental General Conditions and in such form as shall protect him performing work covered by this Contract, or the Town of Dedham and its employees, agents and officials, from all claims and liability for damages for bodily injury, including accidental death, and for property damage, which may arise from operations under this Contract. The Contractor covenants and agrees to hold the Town and its employees, agents and officials harmless from loss or damage due to claims for personal injury and/or property damage arising from, or in connection with operations under this Contract.

25 Affirmative Action/Equal Employment Opportunity Laws and Regulations

The Town of Dedham is an affirmative action/equal opportunity owner/purchaser. The bidder's attention is directed to all applicable State Laws, Town Bylaws, and rules and regulations regarding affirmative action/equal employment opportunity requirements. Failure of a bidder to comply with any such law, bylaw, rule or regulation shall constitute grounds for the Town to reject a bid or to otherwise reject or terminate the award of the contract pursuant to these contract documents.

END OF SECTION

SECTION 00300

FORM OF GENERAL BID

Bid of _____ (hereinafter called "Bidder")*

a corporation, organized and existing under the laws of the state of _____

a partnership

a joint venture

an individual
doing business as _____

To the Town of Dedham, Massachusetts (hereinafter called "Owner").

Gentlemen:

The Bidder, in compliance with your invitation for bids for 2021 Sewer On-Call Services, for the Town of Dedham, Massachusetts,, having examined the plans and specifications with related documents and the site of the proposed work, and being familiar with all of the conditions surrounding the construction of the proposed project including the availability of materials and labor, hereby proposes to furnish all labor, materials, and supplies, and to construct the project in accordance with the contract documents within the time set forth below, and at the prices stated below. These prices are to cover all expenses incurred in performing the work required under the contract documents, of which this proposal is a part.

The Bidder hereby agrees to commence work under this contract on or before a date to be specified in written "Notice to Proceed" of the Owner, and to fully complete the project by December 31, 2021. The Bidder further agrees to pay as liquidated damages the sum of One Thousand (\$1,000) Dollars for each consecutive calendar day thereafter as hereinafter provided in Section 00700 GENERAL CONDITIONS.

*Insert corporation, partnership or individual as applicable.

Bidder acknowledges receipt of the following addenda:

No.: _____ Dated: _____

No.: _____ Dated: _____

No.: _____ Dated: _____

No.: _____ Dated: _____

The Bidder agrees to perform the base bid work described in the specifications and shown on the plans for the following lump sum or unit prices:

Item No.	Estimated Quantity*	Brief Description Unit or Lump Sum Price Bid in Both Words and Figures	Total in Figures
----------	---------------------	--	------------------

1 HOURLY RATE FOR EMERGENCY CLEANING

1a	20 work orders	Emergency Cleaning of Sewers, per work order (4-crew hours per work order)	\$ _____
----	----------------	--	----------

_____ (dollars)

and _____

(cents)
(\$ _____)

1b	20 crew-hours	Emergency Cleaning of Sewers, per crew-hour (hourly rate for each additional hour past a 4-crew hour work order)	\$ _____
----	---------------	--	----------

_____ (dollars)

and _____

(cents)
(\$ _____)

1c	30 tons	Storage, Testing, and Disposal of Sewer Debris, per ton	\$ _____
----	---------	---	----------

_____ (dollars)

and _____

(cents)
(\$ _____)

*Quantity assumed for comparison of bids.

Item No.	Estimated Quantity*	Brief Description Unit or Lump Sum Price Bid in Both Words and Figures	Total in Figures
----------	---------------------	--	------------------

2 HOURLY RATE FOR CLEANING & INSPECTION

2a	30 work orders	Cleaning & Inspection of Sewers, per work order (8-crew hours per work order)	\$ _____
----	----------------	---	----------

_____ (dollars)

and _____

(cents)
(\$ _____)

2b 40 crew-hours Cleaning & Inspection of Sewers, per crew-hour
 (hourly rate for each additional hour past a 8-crew hour work order) \$ _____

 (dollars)
 and _____
 (cents)
 (\$ _____)

2c 30 tons Storage, Testing, and Disposal of Sewer Debris,
 per ton \$ _____

 (dollars)
 and _____
 (cents)
 (\$ _____)

*Quantity assumed for comparison of bids.

Item No.	Estimated Quantity*	Brief Description Unit or Lump Bid in Both Words and Figures	Sum Price Total in Figures
----------	---------------------	--	----------------------------

3 WET WEATHER HEAVY CLEANING OF SEWERS

3a 50 l.f. Heavy Cleaning of 4-inch sewers
 per linear foot \$ _____

 (dollars)
 and _____
 (cents)
 (\$ _____)

3b 250 l.f. Heavy Cleaning of 6-inch sewers
 per linear foot \$ _____

 (dollars)
 and _____
 (cents)
 (\$ _____)

3c	5,000 l.f.	Heavy Cleaning of 8-inch sewers per linear foot	\$ _____

		(dollars)	
		and	

		(cents)	
		(\$ _____)	
3d	1,000 l.f.	Heavy Cleaning of 10-inch sewers per linear foot	\$ _____

		(dollars)	
		and	

		(cents)	
		(\$ _____)	
3e	2,000 l.f.	Heavy Cleaning of 12-inch sewers per linear foot	\$ _____

		(dollars)	
		and	

		(cents)	
		(\$ _____)	
3f	1,000 l.f.	Heavy Cleaning of 15-inch sewers per linear foot	\$ _____

		(dollars)	
		and	

		(cents)	
		(\$ _____)	
3g	250 l.f.	Heavy Cleaning of 18-inch sewers per linear foot	\$ _____

		(dollars)	
		and	

		(cents)	
		(\$ _____)	

3h	50 l.f.	Heavy Cleaning of 20-inch sewers per linear foot	\$ _____

		(dollars)	
		and	

		(cents)	
		(\$ _____)	
3i	250 l.f.	Heavy Cleaning of 21-inch sewers per linear foot	\$ _____

		(dollars)	
		and	

		(cents)	
		(\$ _____)	
3j	50 l.f.	Heavy Cleaning of 22-inch sewers per linear foot	\$ _____

		(dollars)	
		and	

		(cents)	
		(\$ _____)	
3k	1,000 l.f.	Heavy Cleaning of 24-inch sewers per linear foot	\$ _____

		(dollars)	
		and	

		(cents)	
		(\$ _____)	

*Quantity assumed for comparison of bids.

Item No.	Estimated Quantity*	Brief Description Unit or Lump Sum Price Bid in Both Words and Figures	Total in Figures
----------	---------------------	--	------------------

4 WET WEATHER INSPECTION OF SEWERS

4a	200 l.f.	Inspection of 4-inch sewers per linear foot	\$ _____
----	----------	---	----------

_____ (dollars)
 and _____ (cents)
 (\$ _____)

4b	1,750 l.f.	Inspection of 6-inch sewers per linear foot	\$ _____
----	------------	---	----------

_____ (dollars)
 and _____ (cents)
 (\$ _____)

4c	70,000 l.f.	Inspection of 8-inch sewers per linear foot	\$ _____
----	-------------	---	----------

_____ (dollars)
 and _____ (cents)
 (\$ _____)

4d	7,250 l.f.	Inspection of 10-inch sewers per linear foot	\$ _____
----	------------	--	----------

_____ (dollars)
 and _____ (cents)
 (\$ _____)

4e	18,000 l.f.	Inspection of 12-inch sewers per linear foot	\$ _____
----	-------------	--	----------

_____ (dollars)
 and _____ (cents)
 (\$ _____)

4f	8,250 l.f.	Inspection of 15-inch sewers per linear foot	\$ _____

		(dollars)	
		and	

		(cents)	
		(\$ _____)	
4g	3,500 l.f.	Inspection of 18-inch sewers per linear foot	\$ _____

		(dollars)	
		and	

		(cents)	
		(\$ _____)	
4h	500 l.f.	Inspection of 20-inch sewers per linear foot	\$ _____

		(dollars)	
		and	

		(cents)	
		(\$ _____)	
4i	2,250 l.f.	Inspection of 21-inch sewers per linear foot	\$ _____

		(dollars)	
		and	

		(cents)	
		(\$ _____)	
4j	500 l.f.	Inspection of 22-inch sewers per linear foot	\$ _____

		(dollars)	
		and	

		(cents)	
		(\$ _____)	

4k	7,250 l.f.	Inspection of 24-inch sewers per linear foot	\$ _____

			(dollars)
			and _____
			(cents)
			(\$ _____)

*Quantity assumed for comparison of bids.

5 MOBILIZATION (WET WEATHER HEAVY CLEANING & INSPECTIONS)

5a	1	Mobilization (not more than 5% for Items 3 and 4), Lump sum	\$ _____

			(dollars)
			and _____
			(cents)
			(\$ _____)

*Quantity assumed for comparison of bids.

Item No.	Estimated Quantity*	Brief Description Bid in Both Words and Figures	Unit or Lump Sum Price	Total in Figures
----------	---------------------	--	------------------------	------------------

6 ON-CALL SEWER REPAIR

6a	10 l.f.	Structural short liners of 6-inch sewers, per linear foot	\$ _____

			(dollars)
			and _____
			(cents)
			(\$ _____)

- 6b 25 l.f. Structural short liners of 8-inch sewers,
per linear foot \$ _____

(dollars)
and _____
(cents)
(\$ _____)
- 6c 10 l.f. Structural short liners of 10-inch sewers,
per linear foot \$ _____

(dollars)
and _____
(cents)
(\$ _____)
- 6d 25 l.f. Structural short liners of 12-inch sewers,
per linear foot \$ _____

(dollars)
and _____
(cents)
(\$ _____)
- 6e 10 l.f. Structural short liners of 15-inch sewers,
per linear foot \$ _____

(dollars)
and _____
(cents)
(\$ _____)
- 6f 10 l.f. Structural short liners of 18-inch sewers,
per linear foot \$ _____

(dollars)
and _____
(cents)
(\$ _____)

- 6g 250 l.f. Structural line pipe (cured-in-place) of 6-inch sewer,
per linear foot \$ _____

(dollars)
and _____
(cents)
(\$ _____)
- 6h 4,000 l.f. Structural line pipe (cured-in-place) of 8-inch sewer,
per linear foot \$ _____

(dollars)
and _____
(cents)
(\$ _____)
- 6i 250 l.f. Structural line pipe (cured-in-place) of 10-inch sewer,
per linear foot \$ _____

(dollars)
and _____
(cents)
(\$ _____)
- 6j 1,000 l.f. Structural line pipe (cured-in-place) of 12-inch sewer,
per linear foot \$ _____

(dollars)
and _____
(cents)
(\$ _____)
- 6k 250 l.f. Structural line pipe (cured-in-place) of 15-inch sewer,
per linear foot \$ _____

(dollars)
and _____
(cents)
(\$ _____)

- 6l 250 l.f. Structural line pipe (cured-in-place) of 18-inch sewer,
per linear foot \$ _____

(dollars)
and _____
(cents)
(\$ _____)
- 6m 250 l.f. Structural line pipe (cured-in-place) of 20-inch sewer,
per linear foot \$ _____

(dollars)
and _____
(cents)
(\$ _____)
- 6n 250 l.f. Structural line pipe (cured-in-place) of 24-inch sewer,
per linear foot \$ _____

(dollars)
and _____
(cents)
(\$ _____)

*Quantity assumed for comparison of bids.

<u>Item No.</u>	<u>Estimated Quantity*</u>	<u>Brief Description Unit or Lump Sum Price Bid in Both Words and Figures</u>	<u>Total in Figures</u>
-----------------	----------------------------	---	-------------------------

SEWER MANHOLE REHABILITATION

- 7a 650 v.f. Exterior chemical grouting and interior cementitious lining
per vertical foot \$ _____

(dollars)
and _____
(cents)
(\$ _____)

8 MOBILIZATION (SEWER REPAIR)

8a 1 Mobilization (not more than 5% for Items 6 and 7),
 lump sum \$ _____

 (dollars)
 and _____
 (cents)
 (\$ _____)

*Quantity assumed for comparison of bids.

Item No.	Estimated Quantity*	Brief Description Unit or Lump Sum Price Bid in Both Words and Figures	Total in Figures
----------	---------------------	--	------------------

9 CHEMICAL ROOT TREATMENT

9a 500 l.f. Chemical Root Treatment of 6-inch sewers
 per linear foot \$ _____

 (dollars)
 and _____
 (cents)
 (\$ _____)

9b 25,000 l.f. Chemical Root Treatment of 8-inch sewers
 per linear foot \$ _____

 (dollars)
 and _____
 (cents)
 (\$ _____)

9c 1,000 l.f. Chemical Root Treatment of 10-inch sewers
 per linear foot \$ _____

 (dollars)
 and _____
 (cents)
 (\$ _____)

- 9d 1,000 l.f. Chemical Root Treatment of 12-inch sewers
per linear foot \$ _____
_____ (dollars)
and _____
_____ (cents)
(\$ _____)
- 9e 300 l.f. Chemical Root Treatment of 15-inch sewers
per linear foot \$ _____
_____ (dollars)
and _____
_____ (cents)
(\$ _____)
- 9f 300 l.f. Chemical Root Treatment of 18-inch sewers
per linear foot \$ _____
_____ (dollars)
and _____
_____ (cents)
(\$ _____)
- 9g 300 l.f. Chemical Root Treatment of 20-inch sewers
per linear foot \$ _____
_____ (dollars)
and _____
_____ (cents)
(\$ _____)
- 9h 10 manholes Chemical Root Treatment of manholes,
per manhole \$ _____
_____ (dollars)
and _____
_____ (cents)
(\$ _____)

10

MOBILIZATION (CHEMICAL ROOT TREATMENT)

10a 1

Mobilization (not more than 5% for Item 9),
lump sum

\$ _____

(dollars)

and

(cents)

(\$ _____)

*Quantity assumed for comparison of bids.

TOTAL OF CONTRACT (ITEMS 1 – 10)

The computed contract price for all Items 1 through 10 inclusive is:

_____ Dollars and _____ Cents (\$ _____)

The above unit prices shall include all labor, materials, bailing, shoring, removal, overhead, profit, insurance, etc., to cover the finished work of the several kinds called for.

The Bidder understands that all bids for this project are subject to the applicable bidding laws of the Commonwealth of Massachusetts, including General Laws Chapter 30, Section 39M, as amended.

The Bidder understands that the Owner reserves the right to reject any or all bids and to waive any informalities in the bidding.

The Bidder agrees that this bid shall be good and may not be withdrawn for a period of 30 days, Saturdays, Sundays and legal holidays excluded, after the opening of bids.

Within 10 days of receipt of the written notice of acceptance of this bid, the Bidder will execute the formal Agreement attached in Section 00500 CONTRACT.

Bid security is attached in the sum of five percent (5%) of the total bid in accordance with the conditions of Section 00100 INSTRUCTIONS TO BIDDERS. The bid security may become the property of the Owner in the event the contract and bond are not executed within the time set forth above.

The selected Contractor shall furnish a performance bond and a payment bond in an amount at least equal to one hundred percent (100%) of the contract prices in accordance with Section 00610 PERFORMANCE BOND, Section 00620 PAYMENT BOND, and as stipulated in Section 00700 GENERAL CONDITIONS of these specifications.

The undersigned offers the following information as evidence of his qualifications to perform the work as bid upon according to all the requirements of the plans and specifications.

1. Have been in business under present name for ____ years.
2. The names and addresses of all persons interested in the bid (if made by a partnership or corporation) as Principals, are as follows:

(attach supplementary list if necessary)

3. The bidder is requested to state below what work of a similar character to that included in the proposed contract he has done, and give references that will enable the Owner to judge his experience, skill and business standing (add supplementary page if necessary).

<u>Completion Date</u>	<u>Project Name</u>	<u>Contract Amount</u>	<u>Design Engineer</u>	<u>Reference Name</u>	<u>Telephone No.</u>
----------------------------	-------------------------	----------------------------	----------------------------	---------------------------	--------------------------

a. _____

b. _____

c. _____

d. _____

e. _____

f. _____

4. Bank reference _____

(Name)

(Bank)

(Address)

(Telephone No.)

Pursuant to M.G.L. CH. 62C, Sec 49A, I certify under the penalties of perjury that I, to my best knowledge and belief, have filed all state tax returns and paid all State Taxes Required under law.

The undersigned hereby certifies that he is able to furnish labor that can work in harmony with all other elements of labor employed or to be employed in the work.

The undersigned Bidder hereby certifies he/she will comply with the minority workforce percentage ratio and specific affirmative action steps contained in the EEO/AA provisions of this Contract, including compliance with the Minority/Woman Business Enterprise policy as required under these contract provisions. The contractor receiving the award of the contract shall be required to obtain from each of its subcontractors a copy of the certification by said subcontractor, regardless of tier, that it will comply with the minority workforce ratio and specific affirmative action steps contained in these EEO/AA contract provisions and submit it to the contracting agency prior to the award of such subcontract.

The undersigned certifies under penalties of perjury that this bid is in all respects bona fide, fair and made without collusion or fraud with any other person. As used in this paragraph the word "person" shall mean any natural person, joint venture, partnership, corporation or other business or legal entity.

Respectfully submitted:

Date: _____

By: _____
(Signature)

(SEAL - if bid is by
a corporation)

(Name of Bidder)

(Title)

(Business Address)

(City and State)

(Telephone Number)

SECTION 00500
AGREEMENT

THIS AGREEMENT, made this _____ day of _____,
20____, by and between the party of the first part, the Town of Dedham, hereinafter called
"OWNER," acting herein through its Town Manager, and the party of the second part,
_____ doing business as *(an individual)
(a partnership) (a joint venture) (a corporation) located in the *
(City) (Town) of _____, County of _____, and State of
_____, hereinafter called "CONTRACTOR."

WITNESSETH: That for and in consideration of the payments and agreements
hereinafter mentioned, to be made and performed by the OWNER, the CONTRACTOR hereby
agrees with the OWNER to commence and complete the project described as follows:

2021 Sewer On-Call Services

hereinafter called the project, for the sum of

_____ Dollars

(\$ _____) and all extra work in connection therewith, under the terms as stated in
the Contract Documents; and at his (its or their) own proper cost and expense to furnish all the
materials, supplies, machinery equipment, tools, superintendence, labor, insurance, and other
accessories and services necessary to complete the said project in accordance with the conditions
and prices stated in Section 00300 FORM OF GENERAL BID, Section 00700 GENERAL
CONDITIONS, and Section 00800 SUPPLEMENTAL GENERAL CONDITIONS, the plans,
which include all maps, plates, blue prints, and the specifications and Contract Documents as
prepared by the Owner.

*Strike out inapplicable term.

The CONTRACTOR hereby agrees to commence work under this Contract on or before a date to be specified in written "Notice to Proceed" of the OWNER.

The CONTRACTOR further agrees to fully complete the project by December 31, 2021.

The CONTRACTOR further agrees to pay as liquidated damages the sum of \$1,000 for each consecutive calendar day thereafter as provided in the Liquidated Damages Paragraph of Section 00700 GENERAL CONDITIONS.

The CONTRACTOR agrees not to discriminate against or exclude any person from participation herein on grounds of race, religion, color, sex, age or national origin; and that it shall take affirmative actions to insure that applicants are employed, and that employees are treated during their employment, without regard to race, religion, color, sex, age, handicapped status, or national origin.

The CONTRACTOR agrees not to participate in or cooperate with an international boycott, as defined in Section 999 (b)(3) and (4) of the Internal Revenue Code of 1954, as amended, or engage in conduct declared to be unlawful by Section 2 of Chapter 151E of the Massachusetts General Laws.

The OWNER agrees to pay the CONTRACTOR in current funds for the performance of the contract, subject to additions and deductions, as provided in Section 00700 GENERAL CONDITIONS, and to make payments on account thereof as provided in the Estimates and Payments Paragraph of Section 00700 GENERAL CONDITIONS.

IN WITNESS WHEREOF, the parties to these presents have executed this contract in four (4) counterparts, each of which shall be deemed an original, in the year and day first above mentioned.

AGREED:

TOWN OF DEDHAM, MASSACHUSETTS
(Owner)

By _____

(Name)

(Title)

CONTRACTOR: _____

By _____

(Name)

(Title)

(Address)

(City and State)

Approved as to Form:

By _____
(Owner's Counsel)

In accordance with M.G.L. C.44, Section 31C, this is to certify that an appropriation in the amount of this contract is available therefor and that the _____ has been authorized to execute the contract and approve all requisitions and change orders.

By _____
(Owner's Accountant)

(Name)

CERTIFICATE OF VOTE
(to be filed if Contractor is a Corporation)

I, _____, hereby certify that I am the duly qualified
(Secretary of the Corporation)

and acting Secretary of _____ and I further certify that a meeting of the
(Name of Corporation)

Directors of said Company, duly called and held on _____, at which
(Date of Meeting)

all Directors were present and voting, the following vote was unanimously passed:

VOTED: To authorize and empower

Anyone acting singly, to execute Forms of General Bid, Contracts or Bonds on behalf of the Corporation.

I further certify that the above vote is still in effect and has not been changed or modified in any respect.

By: _____
(Secretary of Corporation)

A True Copy:

Attest: _____
(Notary Public)

My Commission Expires: _____
(Date)

Contractor's Certification

A Contractor will not be eligible for award of a contract unless such Contractor has submitted the following certification, which is deemed a part of the resulting contract:

CONTRACTOR'S CERTIFICATION

Name of the General Contractor

Certifies that:

1. It intends to use the following listed construction trades in the work under the contract

2. Will comply with the minority workforce ratio and specific affirmative action steps contained herein; and
3. Will obtain from each of its subcontractors and submit to the contracting or administering agency prior to the award of any subcontract under this contract the subcontractor's certification required by these bid conditions.
4. As evidenced by the signature of the Contractor's Authorized Signatory below, the Contractor certifies under the pains and penalties of perjury that the Contractor shall not knowingly use undocumented workers in connection with the performance of all Executive Branch contracts; that pursuant to federal requirements, the Contractor shall verify the immigration status of all workers assigned to such contracts without engaging in unlawful discrimination; and that the Contractor shall not knowingly or recklessly alter, falsify, or accept altered or falsified documents from any such worker(s). The Contractor understands and agrees that breach of any of these terms during the period of each contract may be regarded as a material breach, subjecting the Contractor to sanctions, including but not limited to monetary penalties, withholding of payments, contract suspension or termination.

Signature of Authorized
Representative of Contractor

Subcontractor's Certification

Prior to the award of any subcontract, regardless of tier, the prospective subcontractor must execute and submit to the General Contractor the following certification, which will be deemed a part of the resulting subcontract:

SUBCONTRACTOR'S CERTIFICATION

Name of the Subcontractor

certifies that:

1. It intends to use the following listed construction trades in the work under contract

2. Will comply with the minority workforce ratio and specific affirmative action steps contained herein; and
3. Will obtain from each of its subcontractors prior to the award of any subcontract under this contract the subcontractor's certification required by these bid conditions.

Signature of Authorized
Representative of Subcontractor

SECTION 00610
PERFORMANCE BOND

KNOW ALL MEN BY THESE PRESENTS: That we _____
(Name of Contractor)

a _____ hereinafter called "Principal" and
(Corporation, Partnership, Joint Venture or Individual)

_____ of _____, State of _____
(Surety) (City)

hereinafter called the "Surety" and licensed by the State Division of Insurance to do business under the laws of the Commonwealth of Massachusetts, are held and firmly bound to the Town of Dedham, Massachusetts, hereinafter called "Owner", in the penal sum of _____ Dollars (\$ _____) in lawful money of the United States, for the payment of which sum well and truly to be made, we bind ourselves, our heirs, executors, administrators and successors, jointly and severally, firmly by these presents.

THE CONDITION OF THIS OBLIGATION is such that whereas the Principal has entered into a certain contract with the Owner (the "Construction Contract"), dated the _____ day of _____, 20____, for the construction described as follows:

2021 Sewer On-Call Services

NOW, THEREFORE, if the Principal shall well, truly and faithfully perform its duties, all the undertakings, covenants, terms, conditions, and agreements of the Construction Contract during the original term thereof, and any extensions thereof which may be granted by the Owner, with or without notice to the Surety, and if he shall satisfy all claims and demands incurred under the Construction Contract, and shall fully indemnify and save harmless the Owner from all costs and damages which it may suffer by reason of failure to do so, and shall reimburse and repay the Owner all outlay and expense which the Owner may incur in making good any default, then this obligation shall be void; otherwise, this obligation shall remain in full force and effect.

PROVIDED, FURTHER, that the Surety's obligation under this Bond shall arise after (1) the Owner has declared the Principal in default of the Construction Contract or (2) has declared that the Principal has failed, or is otherwise unable or unwilling, to execute the work consistent with, and in conformance to, the Construction Contract (collectively referred to as a "Contractor Default"). The determination of a Contractor Default shall be made solely by the Owner.

When the Surety's obligation under this Bond arises, the Surety, at its sole expense and at the consent and election of the Owner, shall immediately take one of following steps: (1) arrange for the Principal to perform and complete the work of the Construction Contract; (2) arrange for a contractor other than the Principal to perform and complete the work of the Construction

Contract; (3) reimburse the Owner, in a manner and at such time as the Owner shall decide, for all costs and expenses incurred by the Owner in performing and completing the work of the Construction Contract.

If the Surety does not proceed as provided in this Bond with due diligence and all deliberate speed, the Surety shall be deemed to be in default of this Bond, and the Owner shall be entitled to enforce any remedy available to the Owner.

After the Surety's obligation under this Bond arises, the Surety is obligated, to the limit of the amounts of this Bond, for (1) the correction of defective work and completion of the Construction Contract; (2) additional design, professional services, and legal costs, including attorney's fees, resulting from the Contractor Default or from the default of the Surety under this Bond; (3) any additional work beyond the Construction Contract made necessary by the Contractor Default or default of the Surety under this Bond; and (4) liquidated damages as provided in the Construction Contract, or if none are so specified, actual and foreseeable consequential damages resulting from the Contractor Default or default of the Surety under this Bond.

Any proceeding, legal or equitable, under this Bond shall be instituted in any court of competent jurisdiction in the Commonwealth of Massachusetts.

The Surety, for value received, hereby stipulates and agrees that no change, extension of time, alteration or addition to the terms of the Construction Contract or to the work to be performed thereunder or the specifications accompanying the same shall in any way affect its obligation on this bond, and it does hereby waive notice of any such change, extension of time, alteration or addition to the terms of the Construction Contract or to the work or to the specifications.

IN WITNESS WHEREOF, this instrument is executed in _____ () counterparts, each one of which shall be deemed an original, this the _____ day of _____, 20____.

ATTEST:

(Principal Secretary) By _____

(Address-Zip Code)

Witness as to Principal (SEAL)

(Address-Zip Code)

ATTEST:

By _____

(Attorney-in-Fact)

(Address-Zip Code)

Witness as to Surety (SEAL)

(Address-Zip Code)

NOTE: Date of Bond must not be prior to date of Contract. If Contractor is a Partnership, all partners should execute Bond.

SECTION 00620

PAYMENT BOND

KNOW ALL MEN BY THESE PRESENTS: That we _____
(Name of Contractor)

a _____ hereinafter called "Principal" and
(Corporation, Partnership, Joint Venture or Individual)

_____ of _____, State of _____
(Surety) (City)

hereinafter called the "Surety" and licensed by the State Division of Insurance to do business under the laws of the Commonwealth of Massachusetts, are held and firmly bound to the Town of Dedham, Massachusetts, hereinafter called "Owner", in the penal sum of _____ Dollars (\$ _____) in lawful money of the United States, for the payment of which sum well and truly to be made, we bind ourselves, our heirs, executors, administrators and successors, jointly and severally, firmly by these presents.

THE CONDITION OF THIS OBLIGATION is such that whereas the Principal has entered into a certain contract with the Owner (the "Construction Contract"), dated the _____ day of _____, 20 __, for the construction described as follows:

2021 Sewer On-Call Services

NOW, THEREFORE, if the Principal shall well, truly and faithfully perform its duties, all the undertakings, covenants, terms, conditions, and agreements of the Construction Contract during the original term thereof, and any extensions thereof which may be granted by the Owner, with or without notice to the Surety, and if he shall satisfy all claims and demands incurred under the Construction Contract, and shall fully indemnify and save harmless the Owner from all costs and damages which it may suffer by reason of failure to do so, and shall reimburse and repay the Owner all outlay and expense which the Owner may incur in making good any default, then this obligation shall be void; otherwise, this obligation shall remain in full force and effect.

PROVIDED, FURTHER, that the Surety's obligation under this Bond shall arise after (1) the Owner has declared the Principal in default of the Construction Contract or (2) has declared that the Principal has failed, or is otherwise unable or unwilling, to execute the work consistent with, and in conformance to, the Construction Contract (collectively referred to as a "Contractor Default"). The determination of a Contractor Default shall be made solely by the Owner.

PROVIDED, FURTHER, that no final settlement between the Owner and the Contractor shall abridge the right of any beneficiary hereunder, whose claim may be unsatisfied.

IN WITNESS WHEREOF, this instrument is executed in _____ () counterparts, each one of which shall be deemed an original, this the _____ day of _____, 20__.

ATTEST:

Principal

(Principal Secretary)

By

(Address-Zip Code)

Witness as to Principal

(SEAL)

(Address-Zip Code)

ATTEST:

Surety

By

(Attorney-in-Fact)

(Address-Zip Code)

Witness as to Surety

(SEAL)

(Address-Zip Code)

NOTE: Date of Bond must not be prior to date of Contract. If Contractor is a Partnership, all partners should execute Bond.

SECTION 00650
CERTIFICATE OF INSURANCE

The Contractor shall provide certificates of insurance acceptable to the OWNER prior to the commencement of the work. The minimum coverage to be provided shall be as follows:

	Occurrence	Aggregate
<hr/>		
A. Owners Protective Liability:		
Bodily Injury	\$1,000,000	\$1,000,000
Property Damage	\$1,000,000	\$1,000,000
<hr/>		
B. Comprehensive General Liability		
Bodily Injury	\$1,000,000	\$2,000,000
Property Damage	\$1,000,000	\$2,000,000
Including: 1. Operations/Premises 2. XCU 3. Products/Completed Operations 4. Contractual as Below 5. Independent Contractors 6. Broad Form Property Damage 7. Personal Injury		
<hr/>		
C. Auto Liability	Per Person	Per Accident
Bodily Injury	\$1,000,000	\$1,000,000
Property Damage		\$1,000,000
Including: 1. All Owned 2. Hired 3. Non-owned		
<hr/>		
D. Workman's Compensation Compensation Statutory State(s) Coverage B Limit \$1,000,000 if Applicable		
<hr/>		
E. Umbrella Liability \$2,000,000 Aggregate		
<hr/>		
F. Builder's Risk Insurance - "All Risk" Completed Value Form		\$0.00
As Specified in Contract or Agreement		
<hr/>		
G. Pollution Liability Insurance	\$1,000,000	\$1,000,000

CONTRACTUAL LIABILITY

To the fullest extent permitted by Laws and Regulations, CONTRACTOR shall indemnify, and hold harmless OWNER and its consultants, agents and employees from and against all claims, damages, losses and expenses, direct, indirect or consequential (including but not limited to fees and charges of engineers, architects, attorneys and other professionals and court and arbitration costs) arising out of or resulting from performance of the Work, provided that any such claim, damage, loss or expense(s) is attributable to bodily injury, sickness, disease or death, or to injury to or destruction of tangible property (other than the Work itself) including the loss of use resulting there from and (b) is caused in whole or in part by any negligent act or omission of CONTRACTOR, any subcontractor, any person or organization directly or indirectly employed by any of them to perform or furnish any of the Work or anyone for whose acts any of them may be liable, regardless of whether or not it is caused in part by a party indemnified hereunder or arises by or is imposed by Law and Regulations regardless of the negligence of any such party.

In any and all claims against OWNER or any of its consultants, agents or employees by any employee of CONTRACTOR, and subcontractor, any person or organization directly or indirectly employed by any of them to perform or furnish any of the Work or anyone for whose acts any of them may be liable, the indemnification obligation under the above paragraph shall not be limited in any way by any limitation on the amount or type of damages, compensation or benefits payable by or for CONTRACTOR or any such subcontractor or other person or organization under workers' or workmen's compensation acts, disability benefit acts or other employee benefits acts.

Policies B, C, D, and E shall remain in effect during the one year correction period.

Such insurance as is herein certified applies to all operations of the insured in connection with, and necessary and incidental to, the work herein described at the locations stated.

It is hereby understood and agreed that the above policies will not be restrictively amended, materially changed nor canceled without 30 days advance notice by registered mail to OWNER.

Authorized Representative Signature
(Include Evidence of Authorization)

Address

SECTION 00700
GENERAL CONDITIONS

TABLE OF CONTENTS

<u>Article 1 – Definitions and Terminology</u>	1
1.01 Defined Terms	1
1.02 Terminology.....	5
<u>Article 2 – Preliminary Matters</u>	7
2.01 Delivery of Bonds and Evidence of Insurance	7
2.02 Copies of Documents.....	7
2.03 Before Starting Construction	7
2.04 Preconstruction Conference; Designation of Authorized Representatives	8
2.05 Initial Acceptance of Schedules.....	8
2.06 Electronic Transmittals	8
<u>Article 3 – Documents: Intent, Requirements, Reuse</u>	9
3.01 Intent	9
3.02 Reference Standards.....	9
3.03 Reporting and Resolving Discrepancies	9
3.04 Requirements of the Contract Documents	10
3.05 Reuse of Documents	11
<u>Article 4 – Commencement and Progress of the Work</u>	11
4.01 Commencement of Contract Times; Notice to Proceed	11
4.02 Starting the Work.....	11
4.03 Reference Points	12
4.04 Progress Schedule	12
4.05 Delays in Contractor’s Progress.....	12
<u>Article 5 – Availability of Lands; Subsurface and Physical Conditions; Hazardous Environmental Conditions</u>	13
5.01 Availability of Lands	13
5.02 Use of Site and Other Areas.....	14
5.03 Subsurface and Physical Conditions.....	15
5.04 Differing Subsurface or Physical Conditions	15
5.05 Underground Facilities.....	17

5.06	Hazardous Environmental Conditions at Site	19
<u>Article 6 – Bonds and Insurance</u>		21
6.01	Performance, Payment, and Other Bonds	21
6.02	Insurance—General Provisions	22
6.03	Contractor’s Insurance	23
6.04	Owner’s Liability Insurance	25
6.05	Property Insurance	26
6.06	Waiver of Rights	28
6.07	Receipt and Application of Property Insurance Proceeds.....	29
<u>Article 7 – Contractor’s Responsibilities</u>		29
7.01	Supervision and Superintendence	29
7.02	Labor; Working Hours	30
7.03	Services, Materials, and Equipment.....	30
7.04	“Or Equals”	30
7.05	Substitutes	31
7.06	Concerning Subcontractors, Suppliers, and Others	33
7.07	Patent Fees and Royalties	35
7.08	Permits	35
7.09	Taxes	36
7.10	Laws and Regulations	36
7.11	Record Documents.....	36
7.12	Safety and Protection	37
7.13	Safety Representative.....	38
7.14	Hazard Communication Programs.....	38
7.15	Emergencies	38
7.16	Shop Drawings, Samples, and Other Submittals	38
7.17	Contractor’s General Warranty and Guarantee.....	41
7.18	Indemnification	41
7.19	Delegation of Professional Design Services	42
<u>Article 8 – Other Work at the Site</u>		42
8.01	Other Work	42
8.02	Coordination	42
8.03	Legal Relationships.....	42

<u>Article 9 – Owner’s Responsibilities</u>	45
9.01 Communications to Contractor	45
9.02 Replacement of Engineer	45
9.03 Furnish Data	45
9.04 Pay When Due	45
9.05 Lands and Easements; Reports, Tests, and Drawings.....	46
9.06 Insurance	46
9.07 Change Orders	46
9.08 Inspections, Tests, and Approvals	46
9.09 Limitations on Owner’s Responsibilities.....	46
9.10 Undisclosed Hazardous Environmental Condition.....	46
9.11 Evidence of Financial Arrangements.....	46
9.12 Safety Programs	46
<u>Article 10 – Engineer’s Status During Construction</u>	47
10.01 Owner’s Representative	46
10.02 Visits to Site	47
10.03 Project Representative	47
10.04 Rejecting Defective Work.....	47
10.05 Shop Drawings, Change Orders and Payments	47
10.06 Determinations for Unit Price Work.....	48
10.07 Decisions on Requirements of Contract Documents and Acceptability of Work ...	48
10.08 Limitations on Engineer’s Authority and Responsibilities	48
10.09 Compliance with Safety Program	49
<u>Article 11 – Amending the Contract Documents; Changes in the Work</u>	49
11.01 Amending and Supplementing Contract Documents.....	49
11.02 Owner-Authorized Changes in the Work	50
11.03 Unauthorized Changes in the Work.....	50
11.04 Change of Contract Price	50
11.05 Change of Contract Times	51
11.06 Change Proposals.....	51
11.07 Execution of Change Orders.....	52
11.08 Notification to Surety.....	53
<u>Article 12 – Claims</u>	53

12.01	Claims	53
<u>Article 13 – Cost of the Work; Allowances; Unit Price Work</u>		54
13.01	Cost of the Work	54
13.02	Allowances	57
13.03	Unit Price Work	58
<u>Article 14 – Tests and Inspections; Correction, Removal or Acceptance of Defective Work</u>		59
14.01	Access to Work	59
14.02	Tests, Inspections, and Approvals	59
14.03	Defective Work	60
14.04	Acceptance of Defective Work	60
14.05	Uncovering Work	61
14.06	Owner May Stop the Work	61
14.07	Owner May Correct Defective Work	61
<u>Article 15 – Payments to Contractor; Set-Offs; Completion; Correction Period</u>		62
15.01	Progress Payments	62
15.02	Contractor’s Warranty of Title	66
15.03	Substantial Completion	66
15.04	Partial Use or Occupancy	67
15.05	Final Inspection	67
15.06	Final Payment	68
15.07	Waiver of Claims	69
15.08	Correction Period	69
<u>Article 16 – Suspension of Work and Termination</u>		70
16.01	Owner May Suspend Work	70
16.02	Owner May Terminate for Cause	70
16.03	Owner May Terminate For Convenience	72
16.04	Contractor May Stop Work or Terminate	72
<u>Article 17 – Final Resolution of Disputes</u>		73
17.01	Methods and Procedures	73
<u>Article 18 – Miscellaneous</u>		73
18.01	Giving Notice	73
18.02	Computation of Times	73
18.03	Cumulative Remedies	73

18.04	Limitation of Damages	74
18.05	No Waiver	74
18.06	Survival of Obligations	74
18.07	Controlling Law	74
18.08	Headings	74

SECTION 00700

GENERAL CONDITIONS OF THE CONTRACT FOR CONSTRUCTION

ARTICLE 1 – DEFINITIONS AND TERMINOLOGY

1.01 *Defined Terms*

- A. Wherever used in the Bidding Requirements or Contract Documents, a term printed with initial capital letters, including the term's singular and plural forms, will have the meaning indicated in the definitions below. In addition to terms specifically defined, terms with initial capital letters in the Contract Documents include references to identified articles and paragraphs, and the titles of other documents or forms.
1. *Addenda*—Written or graphic instruments issued prior to the opening of Bids which clarify, correct, or change the Bidding Requirements or the proposed Contract Documents.
 2. *Agreement*—The written instrument, executed by Owner and Contractor, that sets forth the Contract Price and Contract Times, identifies the parties and the Engineer, and designates the specific items that are Contract Documents.
 3. *Application for Payment*—The form acceptable to Engineer which is to be used by Contractor during the course of the Work in requesting progress or final payments and which is to be accompanied by such supporting documentation as is required by the Contract Documents.
 4. *Bid*—The offer of a Bidder submitted on the prescribed form setting forth the prices for the Work to be performed.
 5. *Bidder*—An individual or entity that submits a Bid to Owner.
 6. *Bidding Documents*—The Bidding Requirements, the proposed Contract Documents, and all Addenda.
 7. *Bidding Requirements*—The advertisement or invitation to bid, Instructions to Bidders, Bid Bond or other Bid security, if any, the Bid Form, and the Bid with any attachments.
 8. *Change Order*—A document which is signed by Contractor and Owner and authorizes an addition, deletion, or revision in the Work or an adjustment in the Contract Price or the Contract Times, or other revision to the Contract, issued on or after the Effective Date of the Contract.
 9. *Change Proposal*—A written request by Contractor, duly submitted in compliance with the procedural requirements set forth herein, seeking an adjustment in Contract Price or Contract Times, or both; contesting an initial decision by Engineer concerning the requirements of the Contract Documents or the acceptability of Work under the Contract Documents; challenging a set-off

against payments due; or seeking other relief with respect to the terms of the Contract.

10. *Claim*—(a) A demand or assertion by Owner directly to Contractor, duly submitted in compliance with the procedural requirements set forth herein: seeking an adjustment of Contract Price or Contract Times, or both; contesting an initial decision by Engineer concerning the requirements of the Contract Documents or the acceptability of Work under the Contract Documents; contesting Engineer’s decision regarding a Change Proposal; seeking resolution of a contractual issue that Engineer has declined to address; or seeking other relief with respect to the terms of the Contract; or (b) a demand or assertion by Contractor directly to Owner, duly submitted in compliance with the procedural requirements set forth herein, contesting Engineer’s decision regarding a Change Proposal; or seeking resolution of a contractual issue that Engineer has declined to address. A demand for money or services by a third party is not a Claim.
11. *Constituent of Concern*—Asbestos, petroleum, radioactive materials, polychlorinated biphenyls (PCBs), hazardous waste, and any substance, product, waste, or other material of any nature whatsoever that is or becomes listed, regulated, or addressed pursuant to (a) the Comprehensive Environmental Response, Compensation and Liability Act, 42 U.S.C. §§9601 et seq. (“CERCLA”); (b) the Hazardous Materials Transportation Act, 49 U.S.C. §§5101 et seq.; (c) the Resource Conservation and Recovery Act, 42 U.S.C. §§6901 et seq. (“RCRA”); (d) the Toxic Substances Control Act, 15 U.S.C. §§2601 et seq.; (e) the Clean Water Act, 33 U.S.C. §§1251 et seq.; (f) the Clean Air Act, 42 U.S.C. §§7401 et seq.; or (g) any other federal, state, or local statute, law, rule, regulation, ordinance, resolution, code, order, or decree regulating, relating to, or imposing liability or standards of conduct concerning, any hazardous, toxic, or dangerous waste, substance, or material.
12. *Contract*—The entire and integrated written contract between the Owner and Contractor concerning the Work.
13. *Contract Documents*—Those items so designated in the Agreement, and which together comprise the Contract.
14. *Contract Price*—The money that Owner has agreed to pay Contractor for completion of the Work in accordance with the Contract Documents. .
15. *Contract Times*—The number of days or the dates by which Contractor shall: (a) achieve Milestones, if any; (b) achieve Substantial Completion; and (c) complete the Work.
16. *Contractor*—The individual or entity with which Owner has contracted for performance of the Work.
17. *Cost of the Work*—See Paragraph 13.01 for definition.
18. *Drawings*—The part of the Contract that graphically shows the scope, extent, and character of the Work to be performed by Contractor.

19. *Effective Date of the Contract*—The date, indicated in the Agreement, on which the Contract becomes effective.
20. *Engineer*—The individual or entity named as such in the Agreement.
21. *Field Order*—A written order issued by Engineer which requires minor changes in the Work but does not change the Contract Price or the Contract Times.
22. *Hazardous Environmental Condition*—The presence at the Site of Constituents of Concern in such quantities or circumstances that may present a danger to persons or property exposed thereto. The presence at the Site of materials that are necessary for the execution of the Work, or that are to be incorporated in the Work, and that are controlled and contained pursuant to industry practices, Laws and Regulations, and the requirements of the Contract, does not establish a Hazardous Environmental Condition.
23. *Laws and Regulations; Laws or Regulations*—Any and all applicable laws, statutes, rules, regulations, ordinances, codes, and orders of any and all governmental bodies, agencies, authorities, and courts having jurisdiction.
24. *Liens*—Charges, security interests, or encumbrances upon Contract-related funds, real property, or personal property.
25. *Milestone*—A principal event in the performance of the Work that the Contract requires Contractor to achieve by an intermediate completion date or by a time prior to Substantial Completion of all the Work.
26. *Notice of Award*—The written notice by Owner to a Bidder of Owner's acceptance of the Bid.
27. *Notice to Proceed*—A written notice by Owner to Contractor fixing the date on which the Contract Times will commence to run and on which Contractor shall start to perform the Work.
28. *Owner*—The individual or entity with which Contractor has contracted regarding the Work, and which has agreed to pay Contractor for the performance of the Work, pursuant to the terms of the Contract.
29. *Progress Schedule*—A schedule, prepared and maintained by Contractor, describing the sequence and duration of the activities comprising the Contractor's plan to accomplish the Work within the Contract Times.
30. *Project*—The total undertaking to be accomplished for Owner by engineers, contractors, and others, including planning, study, design, construction, testing, commissioning, and start-up, and of which the Work to be performed under the Contract Documents is a part.
31. *Project Manual*—The written documents prepared for, or made available for, procuring and constructing the Work, including but not limited to the Bidding Documents or other construction procurement documents, geotechnical and existing conditions information, the Agreement, bond forms, General Conditions, Supplementary Conditions, and Specifications. The contents of the Project Manual may be bound in one or more volumes.

32. *Resident Project Representative*—The authorized representative of Engineer assigned to assist Engineer at the Site. As used herein, the term Resident Project Representative or “RPR” includes any assistants or field staff of Resident Project Representative.
33. *Samples*—Physical examples of materials, equipment, or workmanship that are representative of some portion of the Work and that establish the standards by which such portion of the Work will be judged.
34. *Schedule of Submittals*—A schedule, prepared and maintained by Contractor, of required submittals and the time requirements for Engineer’s review of the submittals and the performance of related construction activities.
35. *Schedule of Values*—A schedule, prepared and maintained by Contractor, allocating portions of the Contract Price to various portions of the Work and used as the basis for reviewing Contractor’s Applications for Payment.
36. *Shop Drawings*—All drawings, diagrams, illustrations, schedules, and other data or information that are specifically prepared or assembled by or for Contractor and submitted by Contractor to illustrate some portion of the Work. Shop Drawings, whether approved or not, are not Drawings and are not Contract Documents.
37. *Site*—Lands or areas indicated in the Contract Documents as being furnished by Owner upon which the Work is to be performed, including rights-of-way and easements, and such other lands furnished by Owner which are designated for the use of Contractor.
38. *Specifications*—The part of the Contract that consists of written requirements for materials, equipment, systems, standards, and workmanship as applied to the Work, and certain administrative requirements and procedural matters applicable to the Work.
39. *Subcontractor*—An individual or entity having a direct contract with Contractor or with any other Subcontractor for the performance of a part of the Work.
40. *Substantial Completion*—The time at which the Work (or a specified part thereof) has progressed to the point where, in the opinion of Engineer, the Work (or a specified part thereof) is sufficiently complete, in accordance with the Contract Documents, so that the Work (or a specified part thereof) can be utilized for the purposes for which it is intended. The terms “substantially complete” and “substantially completed” as applied to all or part of the Work refer to Substantial Completion thereof.
41. *Successful Bidder*—The Bidder whose Bid the Owner accepts, and to which the Owner makes an award of contract, subject to stated conditions.
42. *Supplementary Conditions*—The part of the Contract that amends or supplements these General Conditions.
43. *Supplier*—A manufacturer, fabricator, supplier, distributor, materialman, or vendor having a direct contract with Contractor or with any Subcontractor to

furnish materials or equipment to be incorporated in the Work by Contractor or a Subcontractor.

44. *Technical Data*—Those items expressly identified as Technical Data in the Supplementary Conditions, with respect to either (a) subsurface conditions at the Site, or physical conditions relating to existing surface or subsurface structures at the Site (except Underground Facilities) or (b) Hazardous Environmental Conditions at the Site. If no such express identifications of Technical Data have been made with respect to conditions at the Site, then the data contained in boring logs, recorded measurements of subsurface water levels, laboratory test results, and other factual, objective information regarding conditions at the Site that are set forth in any geotechnical or environmental report prepared for the Project and made available to Contractor are hereby defined as Technical Data with respect to conditions at the Site under Paragraphs 5.03, 5.04, and 5.06.
45. *Underground Facilities*—All underground pipelines, conduits, ducts, cables, wires, manholes, vaults, tanks, tunnels, or other such facilities or attachments, and any encasements containing such facilities, including but not limited to those that convey electricity, gases, steam, liquid petroleum products, telephone or other communications, fiber optic transmissions, cable television, water, wastewater, storm water, other liquids or chemicals, or traffic or other control systems.
46. *Unit Price Work*—Work to be paid for on the basis of unit prices.
47. *Work*—The entire construction or the various separately identifiable parts thereof required to be provided under the Contract Documents. Work includes and is the result of performing or providing all labor, services, and documentation necessary to produce such construction; furnishing, installing, and incorporating all materials and equipment into such construction; and may include related services such as testing, start-up, and commissioning, all as required by the Contract Documents.
48. *Work Change Directive*—A written directive to Contractor issued on or after the Effective Date of the Contract, signed by Owner and recommended by Engineer, ordering an addition, deletion, or revision in the Work.

1.02 Terminology

- A. The words and terms discussed in the following paragraphs are not defined but, when used in the Bidding Requirements or Contract Documents, have the indicated meaning.
- B. *Intent of Certain Terms or Adjectives*:
 1. The Contract Documents include the terms “as allowed,” “as approved,” “as ordered,” “as directed” or terms of like effect or import to authorize an exercise of professional judgment by Engineer. In addition, the adjectives “reasonable,” “suitable,” “acceptable,” “proper,” “satisfactory,” or adjectives of like effect or import are used to describe an action or determination of Engineer as to the Work. It is intended that such exercise of professional judgment, action, or determination will be solely to evaluate, in general, the Work for compliance

with the information in the Contract Documents and with the design concept of the Project as a functioning whole as shown or indicated in the Contract Documents (unless there is a specific statement indicating otherwise). The use of any such term or adjective is not intended to and shall not be effective to assign to Engineer any duty or authority to supervise or direct the performance of the Work, or any duty or authority to undertake responsibility contrary to the provisions of Article 10 or any other provision of the Contract Documents.

C. *Day:*

1. The word “day” means a calendar day of 24 hours measured from midnight to the next midnight.

D. *Defective:*

1. The word “defective,” when modifying the word “Work,” refers to Work that is unsatisfactory, faulty, or deficient in that it:
 - a. does not conform to the Contract Documents; or
 - b. does not meet the requirements of any applicable inspection, reference standard, test, or approval referred to in the Contract Documents; or
 - c. has been damaged prior to Engineer’s recommendation of final payment (unless responsibility for the protection thereof has been assumed by Owner at Substantial Completion in accordance with Paragraph 15.03 or 15.04).

E. *Furnish, Install, Perform, Provide:*

1. The word “furnish,” when used in connection with services, materials, or equipment, shall mean to supply and deliver said services, materials, or equipment to the Site (or some other specified location) ready for use or installation and in usable or operable condition.
2. The word “install,” when used in connection with services, materials, or equipment, shall mean to put into use or place in final position said services, materials, or equipment complete and ready for intended use.
3. The words “perform” or “provide,” when used in connection with services, materials, or equipment, shall mean to furnish and install said services, materials, or equipment complete and ready for intended use.
4. If the Contract Documents establish an obligation of Contractor with respect to specific services, materials, or equipment, but do not expressly use any of the four words “furnish,” “install,” “perform,” or “provide,” then Contractor shall furnish and install said services, materials, or equipment complete and ready for intended use.

- F. Unless stated otherwise in the Contract Documents, words or phrases that have a well-known technical or construction industry or trade meaning are used in the Contract Documents in accordance with such recognized meaning.

ARTICLE 2 – PRELIMINARY MATTERS

2.01 *Delivery of Bonds and Evidence of Insurance*

- A. *Bonds*: When Contractor delivers the executed counterparts of the Agreement to Owner, Contractor shall also deliver to Owner such bonds as Contractor may be required to furnish.
- B. *Evidence of Contractor's Insurance*: When Contractor delivers the executed counterparts of the Agreement to Owner, Contractor shall also deliver to Owner, with copies to each named insured and additional insured (as identified in the Supplementary Conditions or elsewhere in the Contract), the certificates and other evidence of insurance required to be provided by Contractor in accordance with Article 6.
- C. *Evidence of Owner's Insurance*: After receipt of the executed counterparts of the Agreement and all required bonds and insurance documentation, Owner shall promptly deliver to Contractor, with copies to each named insured and additional insured (as identified in the Supplementary Conditions or otherwise), the certificates and other evidence of insurance required to be provided by Owner under Article 6.

2.02 *Copies of Documents*

- A. Owner shall furnish to Contractor four printed copies of the Contract (including one fully executed counterpart of the Agreement), and one copy in electronic portable document format (PDF). Additional printed copies will be furnished upon request at the cost of reproduction.
- B. Owner shall maintain and safeguard at least one original printed record version of the Contract, including Drawings and Specifications signed and sealed by Engineer and other design professionals. Owner shall make such original printed record version of the Contract available to Contractor for review. Owner may delegate the responsibilities under this provision to Engineer.

2.03 *Before Starting Construction*

- A. *Preliminary Schedules*: Within 10 days after the Effective Date of the Contract (or as otherwise specifically required by the Contract Documents), Contractor shall submit to Engineer for timely review:
 - 1. a preliminary Progress Schedule indicating the times (numbers of days or dates) for starting and completing the various stages of the Work, including any Milestones specified in the Contract;
 - 2. a preliminary Schedule of Submittals; and
 - 3. a preliminary Schedule of Values for all of the Work which includes quantities and prices of items which when added together equal the Contract Price and subdivides the Work into component parts in sufficient detail to serve as the basis for progress payments during performance of the Work. Such prices will include an appropriate amount of overhead and profit applicable to each item of Work.

2.04 *Preconstruction Conference; Designation of Authorized Representatives*

- A. Before any Work at the Site is started, a conference attended by Owner, Contractor, Engineer, and others as appropriate will be held to establish a working understanding among the parties as to the Work and to discuss the schedules referred to in Paragraph 2.03.A, procedures for handling Shop Drawings, Samples, and other submittals, processing Applications for Payment, electronic or digital transmittals, and maintaining required records.
- B. At this conference Owner and Contractor each shall designate, in writing, a specific individual to act as its authorized representative with respect to the services and responsibilities under the Contract. Such individuals shall have the authority to transmit and receive information, render decisions relative to the Contract, and otherwise act on behalf of each respective party.

2.05 *Initial Acceptance of Schedules*

- A. At least 10 days before submission of the first Application for Payment a conference, attended by Contractor, Engineer, and others as appropriate, will be held to review for acceptability to Engineer as provided below the schedules submitted in accordance with Paragraph 2.03.A. Contractor shall have an additional 10 days to make corrections and adjustments and to complete and resubmit the schedules. No progress payment shall be made to Contractor until acceptable schedules are submitted to Engineer.
 - 1. The Progress Schedule will be acceptable to Engineer if it provides an orderly progression of the Work to completion within the Contract Times. Such acceptance will not impose on Engineer responsibility for the Progress Schedule, for sequencing, scheduling, or progress of the Work, nor interfere with or relieve Contractor from Contractor's full responsibility therefor.
 - 2. Contractor's Schedule of Submittals will be acceptable to Engineer if it provides a workable arrangement for reviewing and processing the required submittals.
 - 3. Contractor's Schedule of Values will be acceptable to Engineer as to form and substance if it provides a reasonable allocation of the Contract Price to the component parts of the Work.

2.06 *Electronic Transmittals*

- A. Except as otherwise stated elsewhere in the Contract, the Owner, Engineer, and Contractor may transmit, and shall accept, Project-related correspondence, text, data, documents, drawings, information, and graphics, including but not limited to Shop Drawings and other submittals, in electronic media or digital format, either directly, or through access to a secure Project website.
- B. If the Contract does not establish protocols for electronic or digital transmittals, then Owner, Engineer, and Contractor shall jointly develop such protocols.
- C. When transmitting items in electronic media or digital format, the transmitting party makes no representations as to long term compatibility, usability, or readability of the items resulting from the recipient's use of software application packages,

operating systems, or computer hardware differing from those used in the drafting or transmittal of the items, or from those established in applicable transmittal protocols.

ARTICLE 3 – DOCUMENTS: INTENT, REQUIREMENTS, REUSE

3.01 *Intent*

- A. The Contract Documents are complementary; what is required by one is as binding as if required by all.
- B. It is the intent of the Contract Documents to describe a functionally complete project (or part thereof) to be constructed in accordance with the Contract Documents.
- C. Unless otherwise stated in the Contract Documents, if there is a discrepancy between the electronic or digital versions of the Contract Documents (including any printed copies derived from such electronic or digital versions) and the printed record version, the printed record version shall govern.
- D. The Contract supersedes prior negotiations, representations, and agreements, whether written or oral.
- E. Engineer will issue clarifications and interpretations of the Contract Documents as provided herein.

3.02 *Reference Standards*

- A. Standards Specifications, Codes, Laws and Regulations
 - 1. Reference in the Contract Documents to standard specifications, manuals, reference standards, or codes of any technical society, organization, or association, or to Laws or Regulations, whether such reference be specific or by implication, shall mean the standard specification, manual, reference standard, code, or Laws or Regulations in effect at the time of opening of Bids (or on the Effective Date of the Contract if there were no Bids), except as may be otherwise specifically stated in the Contract Documents.
 - 2. No provision of any such standard specification, manual, reference standard, or code, or any instruction of a Supplier, shall be effective to change the duties or responsibilities of Owner, Contractor, or Engineer, or any of their subcontractors, consultants, agents, or employees, from those set forth in the part of the Contract Documents prepared by or for Engineer. No such provision or instruction shall be effective to assign to Owner, Engineer, or any of their officers, directors, members, partners, employees, agents, consultants, or subcontractors, any duty or authority to supervise or direct the performance of the Work or any duty or authority to undertake responsibility inconsistent with the provisions of the part of the Contract Documents prepared by or for Engineer.

3.03 *Reporting and Resolving Discrepancies*

- A. *Reporting Discrepancies:*
 - 1. *Contractor's Verification of Figures and Field Measurements:* Before undertaking each part of the Work, Contractor shall carefully study the Contract

Documents, and check and verify pertinent figures and dimensions therein, particularly with respect to applicable field measurements. Contractor shall promptly report in writing to Engineer any conflict, error, ambiguity, or discrepancy that Contractor discovers, or has actual knowledge of, and shall not proceed with any Work affected thereby until the conflict, error, ambiguity, or discrepancy is resolved, by a clarification or interpretation by Engineer, or by an amendment or supplement to the Contract Documents issued pursuant to Paragraph 11.01.

2. *Contractor's Review of Contract Documents:* If, before or during the performance of the Work, Contractor discovers any conflict, error, ambiguity, or discrepancy within the Contract Documents, or between the Contract Documents and (a) any applicable Law or Regulation, (b) actual field conditions, (c) any standard specification, manual, reference standard, or code, or (d) any instruction of any Supplier, then Contractor shall promptly report it to Engineer in writing. Contractor shall not proceed with the Work affected thereby (except in an emergency as required by Paragraph 7.15) until the conflict, error, ambiguity, or discrepancy is resolved, by a clarification or interpretation by Engineer, or by an amendment or supplement to the Contract Documents issued pursuant to Paragraph 11.01.
3. Contractor shall not be liable to Owner or Engineer for failure to report any conflict, error, ambiguity, or discrepancy in the Contract Documents unless Contractor had actual knowledge thereof.

B. *Resolving Discrepancies:*

1. Except as may be otherwise specifically stated in the Contract Documents, the provisions of the part of the Contract Documents prepared by or for Engineer shall take precedence in resolving any conflict, error, ambiguity, or discrepancy between such provisions of the Contract Documents and:
 - a. the provisions of any standard specification, manual, reference standard, or code, or the instruction of any Supplier (whether or not specifically incorporated by reference as a Contract Document); or
 - b. the provisions of any Laws or Regulations applicable to the performance of the Work (unless such an interpretation of the provisions of the Contract Documents would result in violation of such Law or Regulation).

3.04 *Requirements of the Contract Documents*

- A. During the performance of the Work and until final payment, Contractor and Owner shall submit to the Engineer all matters in question concerning the requirements of the Contract Documents (sometimes referred to as requests for information or interpretation—RFIs), or relating to the acceptability of the Work under the Contract Documents, as soon as possible after such matters arise. Engineer will be the initial interpreter of the requirements of the Contract Documents, and judge of the acceptability of the Work thereunder.
- B. Engineer will, with reasonable promptness, render a written clarification, interpretation, or decision on the issue submitted, or initiate an amendment or

supplement to the Contract Documents. Engineer's written clarification, interpretation, or decision will be final and binding on Contractor, unless it appeals by submitting a Change Proposal, and on Owner, unless it appeals by filing a Claim.

- C. If a submitted matter in question concerns terms and conditions of the Contract Documents that do not involve (1) the performance or acceptability of the Work under the Contract Documents, (2) the design (as set forth in the Drawings, Specifications, or otherwise), or (3) other engineering or technical matters, then Engineer will promptly give written notice to Owner and Contractor that Engineer is unable to provide a decision or interpretation. If Owner and Contractor are unable to agree on resolution of such a matter in question, either party may pursue resolution as provided in Article 12.

3.05 *Reuse of Documents*

- A. Contractor and its Subcontractors and Suppliers shall not:
 - 1. have or acquire any title to or ownership rights in any of the Drawings, Specifications, or other documents (or copies of any thereof) prepared by or bearing the seal of Engineer or its consultants, including electronic media editions, or reuse any such Drawings, Specifications, other documents, or copies thereof on extensions of the Project or any other project without written consent of Owner and Engineer and specific written verification or adaptation by Engineer; or
 - 2. have or acquire any title or ownership rights in any other Contract Documents, reuse any such Contract Documents for any purpose without Owner's express written consent, or violate any copyrights pertaining to such Contract Documents.
- B. The prohibitions of this Paragraph 3.05 will survive final payment, or termination of the Contract. Nothing herein shall preclude Contractor from retaining copies of the Contract Documents for record purposes.

ARTICLE 4 – COMMENCEMENT AND PROGRESS OF THE WORK

4.01 *Commencement of Contract Times; Notice to Proceed*

- A. The Contract Times will commence to run on the thirtieth day after the Effective Date of the Contract or, if a Notice to Proceed is given, on the day indicated in the Notice to Proceed. A Notice to Proceed may be given at any time within 30 days after the Effective Date of the Contract. In no event will the Contract Times commence to run later than the sixtieth day after the day of Bid opening or the thirtieth day after the Effective Date of the Contract, whichever date is earlier.

4.02 *Starting the Work*

- A. Contractor shall start to perform the Work on the date when the Contract Times commence to run. No Work shall be done at the Site prior to such date.

4.03 *Reference Points*

- A. Owner shall provide engineering surveys to establish reference points for construction which in Engineer's judgment are necessary to enable Contractor to proceed with the Work. Contractor shall be responsible for laying out the Work, shall protect and preserve the established reference points and property monuments, and shall make no changes or relocations without the prior written approval of Owner. Contractor shall report to Engineer whenever any reference point or property monument is lost or destroyed or requires relocation because of necessary changes in grades or locations, and shall be responsible for the accurate replacement or relocation of such reference points or property monuments by professionally qualified personnel.

4.04 *Progress Schedule*

- A. Contractor shall adhere to the Progress Schedule established in accordance with Paragraph 2.05 as it may be adjusted from time to time as provided below.
 - 1. Contractor shall submit to Engineer for acceptance (to the extent indicated in Paragraph 2.05) proposed adjustments in the Progress Schedule that will not result in changing the Contract Times.
 - 2. Proposed adjustments in the Progress Schedule that will change the Contract Times shall be submitted in accordance with the requirements of Article 11.
- B. Contractor shall carry on the Work and adhere to the Progress Schedule during all disputes or disagreements with Owner. No Work shall be delayed or postponed pending resolution of any disputes or disagreements, or during any appeal process, except as permitted by Paragraph 16.04, or as Owner and Contractor may otherwise agree in writing.

4.05 *Delays in Contractor's Progress*

- A. If Owner, Engineer, or anyone for whom Owner is responsible, delays, disrupts, or interferes with the performance or progress of the Work, then Contractor shall be entitled to an equitable adjustment in the Contract Times and Contract Price. Contractor's entitlement to an adjustment of the Contract Times is conditioned on such adjustment being essential to Contractor's ability to complete the Work within the Contract Times.
- B. Contractor shall not be entitled to an adjustment in Contract Price or Contract Times for delay, disruption, or interference caused by or within the control of Contractor. Delay, disruption, and interference attributable to and within the control of a Subcontractor or Supplier shall be deemed to be within the control of Contractor.
- C. If Contractor's performance or progress is delayed, disrupted, or interfered with by unanticipated causes not the fault of and beyond the control of Owner, Contractor, and those for which they are responsible, then Contractor shall be entitled to an equitable adjustment in Contract Times. Contractor's entitlement to an adjustment of the Contract Times is conditioned on such adjustment being essential to Contractor's ability to complete the Work within the Contract Times. Such an adjustment shall be Contractor's sole and exclusive remedy for the delays, disruption, and interference

described in this paragraph. Causes of delay, disruption, or interference that may give rise to an adjustment in Contract Times under this paragraph include but are not limited to the following:

1. severe and unavoidable natural catastrophes such as fires, floods, epidemics, and earthquakes;
 2. abnormal weather conditions;
 3. acts or failures to act of utility owners (other than those performing other work at or adjacent to the Site by arrangement with the Owner, as contemplated in Article 8); and
 4. acts of war or terrorism.
- D. Delays, disruption, and interference to the performance or progress of the Work resulting from the existence of a differing subsurface or physical condition, an Underground Facility that was not shown or indicated by the Contract Documents, or not shown or indicated with reasonable accuracy, and those resulting from Hazardous Environmental Conditions, are governed by Article 5.
- E. Paragraph 8.03 governs delays, disruption, and interference to the performance or progress of the Work resulting from the performance of certain other work at or adjacent to the Site.
- F. Contractor shall not be entitled to an adjustment in Contract Price or Contract Times for any delay, disruption, or interference if such delay is concurrent with a delay, disruption, or interference caused by or within the control of Contractor.
- G. Contractor must submit any Change Proposal seeking an adjustment in Contract Price or Contract Times under this paragraph within 30 days of the commencement of the delaying, disrupting, or interfering event.

ARTICLE 5 – AVAILABILITY OF LANDS; SUBSURFACE AND PHYSICAL CONDITIONS; HAZARDOUS ENVIRONMENTAL CONDITIONS

5.01 Availability of Lands

- A. Owner shall furnish the Site. Owner shall notify Contractor of any encumbrances or restrictions not of general application but specifically related to use of the Site with which Contractor must comply in performing the Work.
- B. Upon reasonable written request, Owner shall furnish Contractor with a current statement of record legal title and legal description of the lands upon which permanent improvements are to be made and Owner's interest therein as necessary for giving notice of or filing a mechanic's or construction lien against such lands in accordance with applicable Laws and Regulations.
- C. Contractor shall provide for all additional lands and access thereto that may be required for temporary construction facilities or storage of materials and equipment.

5.02 *Use of Site and Other Areas*

A. *Limitation on Use of Site and Other Areas:*

1. Contractor shall confine construction equipment, temporary construction facilities, the storage of materials and equipment, and the operations of workers to the Site, adjacent areas that Contractor has arranged to use through construction easements or otherwise, and other adjacent areas permitted by Laws and Regulations, and shall not unreasonably encumber the Site and such other adjacent areas with construction equipment or other materials or equipment. Contractor shall assume full responsibility for (a) damage to the Site; (b) damage to any such other adjacent areas used for Contractor's operations; (c) damage to any other adjacent land or areas; and (d) for injuries and losses sustained by the owners or occupants of any such land or areas; provided that such damage or injuries result from the performance of the Work or from other actions or conduct of the Contractor or those for which Contractor is responsible.
 2. If a damage or injury claim is made by the owner or occupant of any such land or area because of the performance of the Work, or because of other actions or conduct of the Contractor or those for which Contractor is responsible, Contractor shall (a) take immediate corrective or remedial action as required by Paragraph 7.12, or otherwise; (b) promptly attempt to settle the claim as to all parties through negotiations with such owner or occupant, or otherwise resolve the claim by arbitration or other dispute resolution proceeding, or at law; and (c) to the fullest extent permitted by Laws and Regulations, indemnify and hold harmless Owner and Engineer, and the officers, directors, members, partners, employees, agents, consultants and subcontractors of each and any of them from and against any such claim, and against all costs, losses, and damages (including but not limited to all fees and charges of engineers, architects, attorneys, and other professionals and all court or arbitration or other dispute resolution costs) arising out of or relating to any claim or action, legal or equitable, brought by any such owner or occupant against Owner, Engineer, or any other party indemnified hereunder to the extent caused directly or indirectly, in whole or in part by, or based upon, Contractor's performance of the Work, or because of other actions or conduct of the Contractor or those for which Contractor is responsible.
- B. *Removal of Debris During Performance of the Work:* During the progress of the Work the Contractor shall keep the Site and other adjacent areas free from accumulations of waste materials, rubbish, and other debris. Removal and disposal of such waste materials, rubbish, and other debris shall conform to applicable Laws and Regulations.
- C. *Cleaning:* Prior to Substantial Completion of the Work Contractor shall clean the Site and the Work and make it ready for utilization by Owner. At the completion of the Work Contractor shall remove from the Site and adjacent areas all tools, appliances, construction equipment and machinery, and surplus materials and shall

restore to original condition all property not designated for alteration by the Contract Documents.

- D. *Loading of Structures*: Contractor shall not load nor permit any part of any structure to be loaded in any manner that will endanger the structure, nor shall Contractor subject any part of the Work or adjacent structures or land to stresses or pressures that will endanger them.

5.03 *Subsurface and Physical Conditions*

- A. *Reports and Drawings*: The Supplementary Conditions identify:

1. those reports known to Owner of explorations and tests of subsurface conditions at or adjacent to the Site;
2. those drawings known to Owner of physical conditions relating to existing surface or subsurface structures at the Site (except Underground Facilities); and
3. Technical Data contained in such reports and drawings.

- B. *Reliance by Contractor on Technical Data Authorized*: Contractor may rely upon the accuracy of the Technical Data expressly identified in the Supplementary Conditions with respect to such reports and drawings, but such reports and drawings are not Contract Documents. If no such express identification has been made, then Contractor may rely upon the accuracy of the Technical Data (as defined in Article 1) contained in any geotechnical or environmental report prepared for the Project and made available to Contractor. Except for such reliance on Technical Data, Contractor may not rely upon or make any claim against Owner or Engineer, or any of their officers, directors, members, partners, employees, agents, consultants, or subcontractors, with respect to:

1. the completeness of such reports and drawings for Contractor's purposes, including, but not limited to, any aspects of the means, methods, techniques, sequences, and procedures of construction to be employed by Contractor, and safety precautions and programs incident thereto; or
2. other data, interpretations, opinions, and information contained in such reports or shown or indicated in such drawings; or
3. any Contractor interpretation of or conclusion drawn from any Technical Data or any such other data, interpretations, opinions, or information.

5.04 *Differing Subsurface or Physical Conditions*

- A. *Notice by Contractor*: If Contractor believes that any subsurface or physical condition that is uncovered or revealed at the Site either:

1. is of such a nature as to establish that any Technical Data on which Contractor is entitled to rely as provided in Paragraph 5.03 is materially inaccurate; or
2. is of such a nature as to require a change in the Drawings or Specifications; or
3. differs materially from that shown or indicated in the Contract Documents; or

4. is of an unusual nature, and differs materially from conditions ordinarily encountered and generally recognized as inherent in work of the character provided for in the Contract Documents;

then Contractor shall, promptly after becoming aware thereof and before further disturbing the subsurface or physical conditions or performing any Work in connection therewith (except in an emergency as required by Paragraph 7.15), notify Owner and Engineer in writing about such condition. Contractor shall not further disturb such condition or perform any Work in connection therewith (except with respect to an emergency) until receipt of a written statement permitting Contractor to do so.

- B. *Engineer's Review:* After receipt of written notice as required by the preceding paragraph, Engineer will promptly review the subsurface or physical condition in question; determine the necessity of Owner's obtaining additional exploration or tests with respect to the condition; conclude whether the condition falls within any one or more of the differing site condition categories in Paragraph 5.04.A above; obtain any pertinent cost or schedule information from Contractor; prepare recommendations to Owner regarding the Contractor's resumption of Work in connection with the subsurface or physical condition in question and the need for any change in the Drawings or Specifications; and advise Owner in writing of Engineer's findings, conclusions, and recommendations.
- C. *Owner's Statement to Contractor Regarding Site Condition:* After receipt of Engineer's written findings, conclusions, and recommendations, Owner shall issue a written statement to Contractor (with a copy to Engineer) regarding the subsurface or physical condition in question, addressing the resumption of Work in connection with such condition, indicating whether any change in the Drawings or Specifications will be made, and adopting or rejecting Engineer's written findings, conclusions, and recommendations, in whole or in part.
- D. *Possible Price and Times Adjustments:*
 1. Contractor shall be entitled to an equitable adjustment in Contract Price or Contract Times, or both, to the extent that the existence of a differing subsurface or physical condition, or any related delay, disruption, or interference, causes an increase or decrease in Contractor's cost of, or time required for, performance of the Work; subject, however, to the following:
 - a. such condition must fall within any one or more of the categories described in Paragraph 5.04.A;
 - b. with respect to Work that is paid for on a unit price basis, any adjustment in Contract Price will be subject to the provisions of Paragraph 13.03; and,
 - c. Contractor's entitlement to an adjustment of the Contract Times is conditioned on such adjustment being essential to Contractor's ability to complete the Work within the Contract Times.

2. Contractor shall not be entitled to any adjustment in the Contract Price or Contract Times with respect to a subsurface or physical condition if:
 - a. Contractor knew of the existence of such condition at the time Contractor made a commitment to Owner with respect to Contract Price and Contract Times by the submission of a Bid or becoming bound under a negotiated contract, or otherwise; or
 - b. the existence of such condition reasonably could have been discovered or revealed as a result of any examination, investigation, exploration, test, or study of the Site and contiguous areas expressly required by the Bidding Requirements or Contract Documents to be conducted by or for Contractor prior to Contractor's making such commitment; or
 - c. Contractor failed to give the written notice as required by Paragraph 5.04.A.
3. If Owner and Contractor agree regarding Contractor's entitlement to and the amount or extent of any adjustment in the Contract Price or Contract Times, or both, then any such adjustment shall be set forth in a Change Order.
4. Contractor may submit a Change Proposal regarding its entitlement to or the amount or extent of any adjustment in the Contract Price or Contract Times, or both, no later than 30 days after Owner's issuance of the Owner's written statement to Contractor regarding the subsurface or physical condition in question.

5.05 *Underground Facilities*

- A. *Contractor's Responsibilities:* The information and data shown or indicated in the Contract Documents with respect to existing Underground Facilities at or adjacent to the Site is based on information and data furnished to Owner or Engineer by the owners of such Underground Facilities, including Owner, or by others. Unless it is otherwise expressly provided in the Supplementary Conditions:
 1. Owner and Engineer do not warrant or guarantee the accuracy or completeness of any such information or data provided by others; and
 2. the cost of all of the following will be included in the Contract Price, and Contractor shall have full responsibility for:
 - a. reviewing and checking all information and data regarding existing Underground Facilities at the Site;
 - b. locating all Underground Facilities shown or indicated in the Contract Documents as being at the Site;
 - c. coordination of the Work with the owners (including Owner) of such Underground Facilities, during construction; and
 - d. the safety and protection of all existing Underground Facilities at the Site, and repairing any damage thereto resulting from the Work.
- B. *Notice by Contractor:* If Contractor believes that an Underground Facility that is uncovered or revealed at the Site was not shown or indicated in the Contract

Documents, or was not shown or indicated with reasonable accuracy, then Contractor shall, promptly after becoming aware thereof and before further disturbing conditions affected thereby or performing any Work in connection therewith (except in an emergency as required by Paragraph 7.15), identify the owner of such Underground Facility and give written notice to that owner and to Owner and Engineer.

- C. *Engineer's Review:* Engineer will promptly review the Underground Facility and conclude whether such Underground Facility was not shown or indicated in the Contract Documents, or was not shown or indicated with reasonable accuracy; obtain any pertinent cost or schedule information from Contractor; prepare recommendations to Owner regarding the Contractor's resumption of Work in connection with the Underground Facility in question; determine the extent, if any, to which a change is required in the Drawings or Specifications to reflect and document the consequences of the existence or location of the Underground Facility; and advise Owner in writing of Engineer's findings, conclusions, and recommendations. During such time, Contractor shall be responsible for the safety and protection of such Underground Facility.
- D. *Owner's Statement to Contractor Regarding Underground Facility:* After receipt of Engineer's written findings, conclusions, and recommendations, Owner shall issue a written statement to Contractor (with a copy to Engineer) regarding the Underground Facility in question, addressing the resumption of Work in connection with such Underground Facility, indicating whether any change in the Drawings or Specifications will be made, and adopting or rejecting Engineer's written findings, conclusions, and recommendations in whole or in part.
- E. *Possible Price and Times Adjustments:*
 - 1. Contractor shall be entitled to an equitable adjustment in the Contract Price or Contract Times, or both, to the extent that any existing Underground Facility at the Site that was not shown or indicated in the Contract Documents, or was not shown or indicated with reasonable accuracy, or any related delay, disruption, or interference, causes an increase or decrease in Contractor's cost of, or time required for, performance of the Work; subject, however, to the following:
 - a. Contractor did not know of and could not reasonably have been expected to be aware of or to have anticipated the existence or actual location of the Underground Facility in question;
 - b. With respect to Work that is paid for on a unit price basis, any adjustment in Contract Price will be subject to the provisions of Paragraph 13.03;
 - c. Contractor's entitlement to an adjustment of the Contract Times is conditioned on such adjustment being essential to Contractor's ability to complete the Work within the Contract Times; and
 - d. Contractor gave the notice required in Paragraph 5.05.B.
 - 2. If Owner and Contractor agree regarding Contractor's entitlement to and the amount or extent of any adjustment in the Contract Price or Contract Times, or both, then any such adjustment shall be set forth in a Change Order.

3. Contractor may submit a Change Proposal regarding its entitlement to or the amount or extent of any adjustment in the Contract Price or Contract Times, or both, no later than 30 days after Owner's issuance of the Owner's written statement to Contractor regarding the Underground Facility in question.

5.06 *Hazardous Environmental Conditions at Site*

- A. *Reports and Drawings*: The Supplementary Conditions identify:
 1. those reports and drawings known to Owner relating to Hazardous Environmental Conditions that have been identified at or adjacent to the Site; and
 2. Technical Data contained in such reports and drawings.
- B. *Reliance by Contractor on Technical Data Authorized*: Contractor may rely upon the accuracy of the Technical Data expressly identified in the Supplementary Conditions with respect to such reports and drawings, but such reports and drawings are not Contract Documents. If no such express identification has been made, then Contractor may rely on the accuracy of the Technical Data (as defined in Article 1) contained in any geotechnical or environmental report prepared for the Project and made available to Contractor. Except for such reliance on Technical Data, Contractor may not rely upon or make any claim against Owner or Engineer, or any of their officers, directors, members, partners, employees, agents, consultants, or subcontractors with respect to:
 1. the completeness of such reports and drawings for Contractor's purposes, including, but not limited to, any aspects of the means, methods, techniques, sequences and procedures of construction to be employed by Contractor and safety precautions and programs incident thereto; or
 2. other data, interpretations, opinions and information contained in such reports or shown or indicated in such drawings; or
 3. any Contractor interpretation of or conclusion drawn from any Technical Data or any such other data, interpretations, opinions or information.
- C. Contractor shall not be responsible for removing or remediating any Hazardous Environmental Condition encountered, uncovered, or revealed at the Site unless such removal or remediation is expressly identified in the Contract Documents to be within the scope of the Work.
- D. Contractor shall be responsible for controlling, containing, and duly removing all Constituents of Concern brought to the Site by Contractor, Subcontractors, Suppliers, or anyone else for whom Contractor is responsible, and for any associated costs; and for the costs of removing and remediating any Hazardous Environmental Condition created by the presence of any such Constituents of Concern.
- E. If Contractor encounters, uncovers, or reveals a Hazardous Environmental Condition whose removal or remediation is not expressly identified in the Contract Documents as being within the scope of the Work, or if Contractor or anyone for whom Contractor is responsible creates a Hazardous Environmental Condition, then Contractor shall immediately: (1) secure or otherwise isolate such condition; (2) stop

all Work in connection with such condition and in any area affected thereby (except in an emergency as required by Paragraph 7.15); and (3) notify Owner and Engineer (and promptly thereafter confirm such notice in writing). Owner shall promptly consult with Engineer concerning the necessity for Owner to retain a qualified expert to evaluate such condition or take corrective action, if any. Promptly after consulting with Engineer, Owner shall take such actions as are necessary to permit Owner to timely obtain required permits and provide Contractor the written notice required by Paragraph 5.06.F. If Contractor or anyone for whom Contractor is responsible created the Hazardous Environmental Condition in question, then Owner may remove and remediate the Hazardous Environmental Condition, and impose a set-off against payments to account for the associated costs.

- F. Contractor shall not resume Work in connection with such Hazardous Environmental Condition or in any affected area until after Owner has obtained any required permits related thereto, and delivered written notice to Contractor either (1) specifying that such condition and any affected area is or has been rendered safe for the resumption of Work, or (2) specifying any special conditions under which such Work may be resumed safely.
- G. If Owner and Contractor cannot agree as to entitlement to or on the amount or extent, if any, of any adjustment in Contract Price or Contract Times, or both, as a result of such Work stoppage or such special conditions under which Work is agreed to be resumed by Contractor, then within 30 days of Owner's written notice regarding the resumption of Work, Contractor may submit a Change Proposal, or Owner may impose a set-off.
- H. If after receipt of such written notice Contractor does not agree to resume such Work based on a reasonable belief it is unsafe, or does not agree to resume such Work under such special conditions, then Owner may order the portion of the Work that is in the area affected by such condition to be deleted from the Work, following the contractual change procedures in Article 11. Owner may have such deleted portion of the Work performed by Owner's own forces or others in accordance with Article 8.
- I. To the fullest extent permitted by Laws and Regulations, Owner shall indemnify and hold harmless Contractor, Subcontractors, and Engineer, and the officers, directors, members, partners, employees, agents, consultants, and subcontractors of each and any of them from and against all claims, costs, losses, and damages (including but not limited to all fees and charges of engineers, architects, attorneys, and other professionals and all court or arbitration or other dispute resolution costs) arising out of or relating to a Hazardous Environmental Condition, provided that such Hazardous Environmental Condition (1) was not shown or indicated in the Drawings, Specifications, or other Contract Documents, identified as Technical Data entitled to limited reliance pursuant to Paragraph 5.06.B, or identified in the Contract Documents to be included within the scope of the Work, and (2) was not created by Contractor or by anyone for whom Contractor is responsible. Nothing in this Paragraph 5.06.I shall obligate Owner to indemnify any individual or entity from and against the consequences of that individual's or entity's own negligence.

- J. To the fullest extent permitted by Laws and Regulations, Contractor shall indemnify and hold harmless Owner and Engineer, and the officers, directors, members, partners, employees, agents, consultants, and subcontractors of each and any of them from and against all claims, costs, losses, and damages (including but not limited to all fees and charges of engineers, architects, attorneys, and other professionals and all court or arbitration or other dispute resolution costs) arising out of or relating to the failure to control, contain, or remove a Constituent of Concern brought to the Site by Contractor or by anyone for whom Contractor is responsible, or to a Hazardous Environmental Condition created by Contractor or by anyone for whom Contractor is responsible. Nothing in this Paragraph 5.06.J shall obligate Contractor to indemnify any individual or entity from and against the consequences of that individual's or entity's own negligence.
- K. The provisions of Paragraphs 5.03, 5.04, and 5.05 do not apply to the presence of Constituents of Concern or to a Hazardous Environmental Condition uncovered or revealed at the Site.

ARTICLE 6 – BONDS AND INSURANCE

6.01 *Performance, Payment, and Other Bonds*

- A. Contractor shall furnish a performance bond and a payment bond, each in an amount at least equal to the Contract Price, as security for the faithful performance and payment of all of Contractor's obligations under the Contract. These bonds shall remain in effect until one year after the date when final payment becomes due or until completion of the correction period specified in Paragraph 15.08, whichever is later, except as provided otherwise by Laws or Regulations, the Supplementary Conditions, or other specific provisions of the Contract. Contractor shall also furnish such other bonds as are required by the Supplementary Conditions or other specific provisions of the Contract.
- B. All bonds shall be in the form prescribed by the Contract except as provided otherwise by Laws or Regulations, and shall be executed by such sureties as are named in "Companies Holding Certificates of Authority as Acceptable Sureties on Federal Bonds and as Acceptable Reinsuring Companies" as published in Circular 570 (as amended and supplemented) by the Financial Management Service, Surety Bond Branch, U.S. Department of the Treasury. A bond signed by an agent or attorney-in-fact must be accompanied by a certified copy of that individual's authority to bind the surety. The evidence of authority shall show that it is effective on the date the agent or attorney-in-fact signed the accompanying bond.
- C. Contractor shall obtain the required bonds from surety companies that are duly licensed or authorized in the jurisdiction in which the Project is located to issue bonds in the required amounts.
- D. If the surety on a bond furnished by Contractor is declared bankrupt or becomes insolvent, or its right to do business is terminated in any state or jurisdiction where any part of the Project is located, or the surety ceases to meet the requirements above, then Contractor shall promptly notify Owner and Engineer and shall, within

20 days after the event giving rise to such notification, provide another bond and surety, both of which shall comply with the bond and surety requirements above.

- E. If Contractor has failed to obtain a required bond, Owner may exclude the Contractor from the Site and exercise Owner's termination rights under Article 16.
- F. Upon request, Owner shall provide a copy of the payment bond to any Subcontractor, Supplier, or other person or entity claiming to have furnished labor or materials used in the performance of the Work.

6.02 *Insurance—General Provisions*

- A. Owner and Contractor shall obtain and maintain insurance as required in this Article and in the Supplementary Conditions.
- B. All insurance required by the Contract to be purchased and maintained by Owner or Contractor shall be obtained from insurance companies that are duly licensed or authorized, in the state or jurisdiction in which the Project is located, to issue insurance policies for the required limits and coverages. Unless a different standard is indicated in the Supplementary Conditions, all companies that provide insurance policies required under this Contract shall have an A.M. Best rating of A-VII or better.
- C. Contractor shall deliver to Owner, with copies to each named insured and additional insured (as identified in this Article, in the Supplementary Conditions, or elsewhere in the Contract), certificates of insurance establishing that Contractor has obtained and is maintaining the policies, coverages, and endorsements required by the Contract. Upon request by Owner or any other insured, Contractor shall also furnish other evidence of such required insurance, including but not limited to copies of policies and endorsements, and documentation of applicable self-insured retentions and deductibles. Contractor may block out (redact) any confidential premium or pricing information contained in any policy or endorsement furnished under this provision.
- D. Owner shall deliver to Contractor, with copies to each named insured and additional insured (as identified in this Article, the Supplementary Conditions, or elsewhere in the Contract), certificates of insurance establishing that Owner has obtained and is maintaining the policies, coverages, and endorsements required of Owner by the Contract (if any). Upon request by Contractor or any other insured, Owner shall also provide other evidence of such required insurance (if any), including but not limited to copies of policies and endorsements, and documentation of applicable self-insured retentions and deductibles. Owner may block out (redact) any confidential premium or pricing information contained in any policy or endorsement furnished under this provision.
- E. Failure of Owner or Contractor to demand such certificates or other evidence of the other party's full compliance with these insurance requirements, or failure of Owner or Contractor to identify a deficiency in compliance from the evidence provided, shall not be construed as a waiver of the other party's obligation to obtain and maintain such insurance.

- F. If either party does not purchase or maintain all of the insurance required of such party by the Contract, such party shall notify the other party in writing of such failure to purchase prior to the start of the Work, or of such failure to maintain prior to any change in the required coverage.
- G. If Contractor has failed to obtain and maintain required insurance, Owner may exclude the Contractor from the Site, impose an appropriate set-off against payment, and exercise Owner's termination rights under Article 16.
- H. Without prejudice to any other right or remedy, if a party has failed to obtain required insurance, the other party may elect to obtain equivalent insurance to protect such other party's interests at the expense of the party who was required to provide such coverage, and the Contract Price shall be adjusted accordingly.
- I. Owner does not represent that insurance coverage and limits established in this Contract necessarily will be adequate to protect Contractor or Contractor's interests.
- J. The insurance and insurance limits required herein shall not be deemed as a limitation on Contractor's liability under the indemnities granted to Owner and other individuals and entities in the Contract.

6.03 *Contractor's Insurance*

- A. *Workers' Compensation*: Contractor shall purchase and maintain workers' compensation and employer's liability insurance for:
 1. claims under workers' compensation, disability benefits, and other similar employee benefit acts.
 2. United States Longshoreman and Harbor Workers' Compensation Act and Jones Act coverage (if applicable).
 3. claims for damages because of bodily injury, occupational sickness or disease, or death of Contractor's employees (by stop-gap endorsement in monopolist worker's compensation states).
 4. Foreign voluntary worker compensation (if applicable).
- B. *Commercial General Liability—Claims Covered*: Contractor shall purchase and maintain commercial general liability insurance, covering all operations by or on behalf of Contractor, on an occurrence basis, against:
 1. claims for damages because of bodily injury, sickness or disease, or death of any person other than Contractor's employees.
 2. claims for damages insured by reasonably available personal injury liability coverage.
 3. claims for damages, other than to the Work itself, because of injury to or destruction of tangible property wherever located, including loss of use resulting therefrom.
- C. *Commercial General Liability—Form and Content*: Contractor's commercial liability policy shall be written on a 1996 (or later) ISO commercial general liability form (occurrence form) and include the following coverages and endorsements:

1. Products and completed operations coverage:
 - a. Such insurance shall be maintained for three years after final payment.
 - b. Contractor shall furnish Owner and each other additional insured (as identified in the Supplementary Conditions or elsewhere in the Contract) evidence of continuation of such insurance at final payment and three years thereafter.
 2. Blanket contractual liability coverage, to the extent permitted by law, including but not limited to coverage of Contractor's contractual indemnity obligations in Paragraph 7.18.
 3. Broad form property damage coverage.
 4. Severability of interest.
 5. Underground, explosion, and collapse coverage.
 6. Personal injury coverage.
 7. Additional insured endorsements that include both ongoing operations and products and completed operations coverage through ISO Endorsements CG 20 10 10 01 and CG 20 37 10 01 (together); or CG 20 10 07 04 and CG 20 37 07 04 (together); or their equivalent.
 8. For design professional additional insureds, ISO Endorsement CG 20 32 07 04, "Additional Insured—Engineers, Architects or Surveyors Not Engaged by the Named Insured" or its equivalent.
- D. *Automobile liability*: Contractor shall purchase and maintain automobile liability insurance against claims for damages because of bodily injury or death of any person or property damage arising out of the ownership, maintenance, or use of any motor vehicle. The automobile liability policy shall be written on an occurrence basis.
- E. *Umbrella or excess liability*: Contractor shall purchase and maintain umbrella or excess liability insurance written over the underlying employer's liability, commercial general liability, and automobile liability insurance described in the paragraphs above. Subject to industry-standard exclusions, the coverage afforded shall follow form as to each and every one of the underlying policies.
- F. *Contractor's pollution liability insurance*: Contractor shall purchase and maintain a policy covering third-party injury and property damage claims, including clean-up costs, as a result of pollution conditions arising from Contractor's operations and completed operations. This insurance shall be maintained for no less than three years after final completion.
- G. *Additional insureds*: The Contractor's commercial general liability, automobile liability, umbrella or excess, and pollution liability policies shall include and list as additional insureds Owner and Engineer, and any individuals or entities identified in the Supplementary Conditions; include coverage for the respective officers, directors, members, partners, employees, agents, consultants, and subcontractors of each and any of all such additional insureds; and the insurance afforded to these additional insureds shall provide primary coverage for all claims covered thereby

(including as applicable those arising from both ongoing and completed operations) on a non-contributory basis. Contractor shall obtain all necessary endorsements to support these requirements. All insurance provided by the Contractor shall be primary and non-contributory with respect to any other insurance available to Additional Insureds.

- H. *Waivers of Subrogation*: The Contractor's commercial general liability, automobile liability, workers' compensation, umbrella or excess liability and pollution liability policies shall provide a Waiver of Subrogation in favor of the Owner and respective officers, directors, members, partners, employees and agents.
- I. *Contractor's professional liability insurance*: If Contractor will provide or furnish professional services under this Contract, through a delegation of professional design services or otherwise, then Contractor shall be responsible for purchasing and maintaining applicable professional liability insurance. This insurance shall provide protection against claims arising out of performance of professional design or related services, and caused by a negligent error, omission, or act for which the insured party is legally liable. It shall be maintained throughout the duration of the Contract and for a minimum of two years after Substantial Completion. If such professional design services are performed by a Subcontractor, and not by Contractor itself, then the requirements of this paragraph may be satisfied through the purchasing and maintenance of such insurance by such Subcontractor.
- J. *General provisions*: The policies of insurance required by this Paragraph 6.03 shall:
 - 1. include at least the specific coverages provided in this Article.
 - 2. be written for not less than the limits of liability provided in this Article and in the Supplementary Conditions, or required by Laws or Regulations, whichever is greater.
 - 3. contain a provision or endorsement that the coverage afforded will not be canceled, materially changed, or renewal refused until at least 10 days prior written notice has been given to Contractor. Within three days of receipt of any such written notice, Contractor shall provide a copy of the notice to Owner, Engineer, and each other insured under the policy.
 - 4. remain in effect at least until final payment (and longer if expressly required in this Article) and at all times thereafter when Contractor may be correcting, removing, or replacing defective Work as a warranty or correction obligation, or otherwise, or returning to the Site to conduct other tasks arising from the Contract Documents.
 - 5. be appropriate for the Work being performed and provide protection from claims that may arise out of or result from Contractor's performance of the Work and Contractor's other obligations under the Contract Documents, whether it is to be performed by Contractor, any Subcontractor or Supplier, or by anyone directly or indirectly employed by any of them to perform any of the Work, or by anyone for whose acts any of them may be liable.

- K. The coverage requirements for specific policies of insurance must be met by such policies, and not by reference to excess or umbrella insurance provided in other policies.

6.04 *Owner's Liability Insurance*

- A. In addition to the insurance required to be provided by Contractor under Paragraph 6.03, Owner, at Owner's option, may purchase and maintain at Owner's expense Owner's own liability insurance as will protect Owner against claims which may arise from operations under the Contract Documents.
- B. Owner's liability policies, if any, operate separately and independently from policies required to be provided by Contractor, and Contractor cannot rely upon Owner's liability policies for any of Contractor's obligations to the Owner, Engineer, or third parties.

6.05 *Property Insurance*

- A. *Builder's Risk*: Unless otherwise provided in the Supplementary Conditions, Contractor shall purchase and maintain builder's risk insurance upon the Work on a completed value basis, in the amount of the full insurable replacement cost thereof (subject to such deductible amounts as may be provided in the Supplementary Conditions or required by Laws and Regulations). This insurance shall:
 - 1. include the Owner and Contractor as named insureds, and all Subcontractors, and any individuals or entities required by the Supplementary Conditions to be insured under such builder's risk policy, as insureds or named insureds. For purposes of the remainder of this Paragraph 6.05, Paragraphs 6.06 and 6.07, and any corresponding Supplementary Conditions, the parties required to be insured shall collectively be referred to as "insureds."
 - 2. be written on a builder's risk "all risk" policy form that shall at least include insurance for physical loss or damage to the Work, temporary buildings, falsework, and materials and equipment in transit, and shall insure against at least the following perils or causes of loss: fire; lightning; windstorm; riot; civil commotion; terrorism; vehicle impact; aircraft; smoke; theft; vandalism and malicious mischief; mechanical breakdown, boiler explosion, and artificially generated electric current; earthquake; volcanic activity, and other earth movement; flood; collapse; explosion; debris removal; demolition occasioned by enforcement of Laws and Regulations; water damage (other than that caused by flood); and such other perils or causes of loss as may be specifically required by the Supplementary Conditions. If insurance against mechanical breakdown, boiler explosion, and artificially generated electric current; earthquake; volcanic activity, and other earth movement; or flood, are not commercially available under builder's risk policies, by endorsement or otherwise, such insurance may be provided through other insurance policies acceptable to Owner and Contractor.
 - 3. cover, as insured property, at least the following: (a) the Work and all materials, supplies, machinery, apparatus, equipment, fixtures, and other property of a similar nature that are to be incorporated into or used in the preparation,

fabrication, construction, erection, or completion of the Work, including Owner-furnished or assigned property; (b) spare parts inventory required within the scope of the Contract; and (c) temporary works which are not intended to form part of the permanent constructed Work but which are intended to provide working access to the Site, or to the Work under construction, or which are intended to provide temporary support for the Work under construction, including scaffolding, form work, fences, shoring, falsework, and temporary structures.

4. cover expenses incurred in the repair or replacement of any insured property (including but not limited to fees and charges of engineers and architects).
 5. extend to cover damage or loss to insured property while in temporary storage at the Site or in a storage location outside the Site (but not including property stored at the premises of a manufacturer or Supplier).
 6. extend to cover damage or loss to insured property while in transit.
 7. allow for partial occupation or use of the Work by Owner, such that those portions of the Work that are not yet occupied or used by Owner shall remain covered by the builder's risk insurance.
 8. allow for the waiver of the insurer's subrogation rights, as set forth below.
 9. provide primary coverage for all losses and damages caused by the perils or causes of loss covered.
 10. not include a co-insurance clause.
 11. include an exception for ensuing losses from physical damage or loss with respect to any defective workmanship, design, or materials exclusions.
 12. include performance/hot testing and start-up.
 13. be maintained in effect, subject to the provisions herein regarding Substantial Completion and partial occupancy or use of the Work by Owner, until the Work is complete.
- B. *Notice of Cancellation or Change:* All the policies of insurance (and the certificates or other evidence thereof) required to be purchased and maintained in accordance with this Paragraph 6.05 will contain a provision or endorsement that the coverage afforded will not be canceled or materially changed or renewal refused until at least 10 days prior written notice has been given to the purchasing policyholder. Within three days of receipt of any such written notice, the purchasing policyholder shall provide a copy of the notice to each other insured.
- C. *Deductibles:* The purchaser of any required builder's risk or property insurance shall pay for costs not covered because of the application of a policy deductible.
- D. *Partial Occupancy or Use by Owner:* If Owner will occupy or use a portion or portions of the Work prior to Substantial Completion of all the Work as provided in Paragraph 15.04, then Owner (directly, if it is the purchaser of the builder's risk policy, or through Contractor) will provide notice of such occupancy or use to the builder's risk insurer. The builder's risk insurance shall not be canceled or permitted

to lapse on account of any such partial use or occupancy; rather, those portions of the Work that are occupied or used by Owner may come off the builder's risk policy, while those portions of the Work not yet occupied or used by Owner shall remain covered by the builder's risk insurance.

- E. *Additional Insurance*: If Contractor elects to obtain other special insurance to be included in or supplement the builder's risk or property insurance policies provided under this Paragraph 6.05, it may do so at Contractor's expense.
- F. *Insurance of Other Property*: If the express insurance provisions of the Contract do not require or address the insurance of a property item or interest, such as tools, construction equipment, or other personal property owned by Contractor, a Subcontractor, or an employee of Contractor or a Subcontractor, then the entity or individual owning such property item will be responsible for deciding whether to insure it, and if so in what amount.

6.06 *Waiver of Rights*

- A. All policies purchased in accordance with Paragraph 6.05, expressly including the builder's risk policy, shall contain provisions to the effect that in the event of payment of any loss or damage the insurers will have no rights of recovery against any insureds thereunder, or against Engineer or its consultants, or their officers, directors, members, partners, employees, agents, consultants, or subcontractors. Owner and Contractor waive all rights against each other and the respective officers, directors, members, partners, employees, agents, consultants, and subcontractors of each and any of them, for all losses and damages caused by, arising out of, or resulting from any of the perils or causes of loss covered by such policies and any other property insurance applicable to the Work; and, in addition, waive all such rights against Engineer, its consultants, all Subcontractors, all individuals or entities identified in the Supplementary Conditions as insureds, and the officers, directors, members, partners, employees, agents, consultants, and subcontractors of each and any of them, under such policies for losses and damages so caused. None of the above waivers shall extend to the rights that any party making such waiver may have to the proceeds of insurance held by Owner or Contractor as trustee or fiduciary, or otherwise payable under any policy so issued.
- B. Owner waives all rights against Contractor, Subcontractors, and Engineer, and the officers, directors, members, partners, employees, agents, consultants and subcontractors of each and any of them, for:
 - 1. loss due to business interruption, loss of use, or other consequential loss extending beyond direct physical loss or damage to Owner's property or the Work caused by, arising out of, or resulting from fire or other perils whether or not insured by Owner; and
 - 2. loss or damage to the completed Project or part thereof caused by, arising out of, or resulting from fire or other insured peril or cause of loss covered by any property insurance maintained on the completed Project or part thereof by Owner during partial occupancy or use pursuant to Paragraph 15.04, after

Substantial Completion pursuant to Paragraph 15.03, or after final payment pursuant to Paragraph 15.06.

- C. Any insurance policy maintained by Owner covering any loss, damage or consequential loss referred to in Paragraph 6.06.B shall contain provisions to the effect that in the event of payment of any such loss, damage, or consequential loss, the insurers will have no rights of recovery against Contractor, Subcontractors, or Engineer, or the officers, directors, members, partners, employees, agents, consultants, or subcontractors of each and any of them.
- D. Contractor shall be responsible for assuring that the agreement under which a Subcontractor performs a portion of the Work contains provisions whereby the Subcontractor waives all rights against Owner, Contractor, all individuals or entities identified in the Supplementary Conditions as insureds, the Engineer and its consultants, and the officers, directors, members, partners, employees, agents, consultants, and subcontractors of each and any of them, for all losses and damages caused by, arising out of, relating to, or resulting from any of the perils or causes of loss covered by builder's risk insurance and any other property insurance applicable to the Work.

6.07 *Receipt and Application of Property Insurance Proceeds*

- A. Any insured loss under the builder's risk and other policies of insurance required by Paragraph 6.05 will be adjusted and settled with the named insured that purchased the policy. Such named insured shall act as fiduciary for the other insureds, and give notice to such other insureds that adjustment and settlement of a claim is in progress. Any other insured may state its position regarding a claim for insured loss in writing within 15 days after notice of such claim.
- B. Proceeds for such insured losses may be made payable by the insurer either jointly to multiple insureds, or to the named insured that purchased the policy in its own right and as fiduciary for other insureds, subject to the requirements of any applicable mortgage clause. A named insured receiving insurance proceeds under the builder's risk and other policies of insurance required by Paragraph 6.05 shall distribute such proceeds in accordance with such agreement as the parties in interest may reach, or as otherwise required under the dispute resolution provisions of this Contract or applicable Laws and Regulations.
- C. If no other special agreement is reached, the damaged Work shall be repaired or replaced, the money so received applied on account thereof, and the Work and the cost thereof covered by Change Order, if needed.

ARTICLE 7 – CONTRACTOR'S RESPONSIBILITIES

7.01 *Supervision and Superintendence*

- A. Contractor shall supervise, inspect, and direct the Work competently and efficiently, devoting such attention thereto and applying such skills and expertise as may be necessary to perform the Work in accordance with the Contract Documents. Contractor shall be solely responsible for the means, methods, techniques, sequences, and procedures of construction.

- B. At all times during the progress of the Work, Contractor shall assign a competent resident superintendent who shall not be replaced without written notice to Owner and Engineer except under extraordinary circumstances.

7.02 *Labor; Working Hours*

- A. Contractor shall provide competent, suitably qualified personnel to survey and lay out the Work and perform construction as required by the Contract Documents. Contractor shall at all times maintain good discipline and order at the Site.
- B. Except as otherwise required for the safety or protection of persons or the Work or property at the Site or adjacent thereto, and except as otherwise stated in the Contract Documents, all Work at the Site shall be performed during regular working hours, Monday through Friday. Contractor will not perform Work on a Saturday, Sunday, or any legal holiday. Contractor may perform Work outside regular working hours or on Saturdays, Sundays, or legal holidays only with Owner's written consent, which will not be unreasonably withheld.

7.03 *Services, Materials, and Equipment*

- A. Unless otherwise specified in the Contract Documents, Contractor shall provide and assume full responsibility for all services, materials, equipment, labor, transportation, construction equipment and machinery, tools, appliances, fuel, power, light, heat, telephone, water, sanitary facilities, temporary facilities, and all other facilities and incidentals necessary for the performance, testing, start up, and completion of the Work, whether or not such items are specifically called for in the Contract Documents.
- B. All materials and equipment incorporated into the Work shall be of good quality and new, except as otherwise provided in the Contract Documents. All special warranties and guarantees required by the Specifications shall expressly run to the benefit of Owner. If required by Engineer, Contractor shall furnish satisfactory evidence (including reports of required tests) as to the source, kind, and quality of materials and equipment.
- C. All materials and equipment shall be stored, applied, installed, connected, erected, protected, used, cleaned, and conditioned in accordance with instructions of the applicable Supplier, except as otherwise may be provided in the Contract Documents.

7.04 *"Or Equals"*

- A. Whenever an item of material or equipment is specified or described in the Contract Documents by using the name of a proprietary item or the name of a particular Supplier, the Contract Price has been based upon Contractor furnishing such item as specified. The specification or description of such an item is intended to establish the type, function, appearance, and quality required. Unless the specification or description contains or is followed by words reading that no like, equivalent, or "or equal" item is permitted, Contractor may request that Engineer authorize the use of other items of material or equipment, or items from other proposed suppliers under the circumstances described below.

1. If Engineer in its sole discretion determines that an item of material or equipment proposed by Contractor is functionally equal to that named and sufficiently similar so that no change in related Work will be required, Engineer shall deem it an “or equal” item. For the purposes of this paragraph, a proposed item of material or equipment will be considered functionally equal to an item so named if:
 - a. in the exercise of reasonable judgment Engineer determines that:
 - 1) it is at least equal in materials of construction, quality, durability, appearance, strength, and design characteristics;
 - 2) it will reliably perform at least equally well the function and achieve the results imposed by the design concept of the completed Project as a functioning whole;
 - 3) it has a proven record of performance and availability of responsive service; and
 - 4) it is not objectionable to Owner.
 - b. Contractor certifies that, if approved and incorporated into the Work:
 - 1) there will be no increase in cost to the Owner or increase in Contract Times; and
 - 2) it will conform substantially to the detailed requirements of the item named in the Contract Documents.
- B. *Contractor’s Expense:* Contractor shall provide all data in support of any proposed “or equal” item at Contractor’s expense.
- C. *Engineer’s Evaluation and Determination:* Engineer will be allowed a reasonable time to evaluate each “or-equal” request. Engineer may require Contractor to furnish additional data about the proposed “or-equal” item. Engineer will be the sole judge of acceptability. No “or-equal” item will be ordered, furnished, installed, or utilized until Engineer’s review is complete and Engineer determines that the proposed item is an “or-equal”, which will be evidenced by an approved Shop Drawing or other written communication. Engineer will advise Contractor in writing of any negative determination.
- D. *Effect of Engineer’s Determination:* Neither approval nor denial of an “or-equal” request shall result in any change in Contract Price. The Engineer’s denial of an “or-equal” request shall be final and binding, and may not be reversed through an appeal under any provision of the Contract Documents.
- E. *Treatment as a Substitution Request:* If Engineer determines that an item of material or equipment proposed by Contractor does not qualify as an “or-equal” item, Contractor may request that Engineer considered the proposed item as a substitute pursuant to Paragraph 7.05.

7.05 *Substitutes*

- A. Unless the specification or description of an item of material or equipment required to be furnished under the Contract Documents contains or is followed by words reading that no substitution is permitted, Contractor may request that Engineer authorize the use of other items of material or equipment under the circumstances described below. To the extent possible such requests shall be made before commencement of related construction at the Site.
1. Contractor shall submit sufficient information as provided below to allow Engineer to determine if the item of material or equipment proposed is functionally equivalent to that named and an acceptable substitute therefor. Engineer will not accept requests for review of proposed substitute items of material or equipment from anyone other than Contractor.
 2. The requirements for review by Engineer will be as set forth in Paragraph 7.05.B, as supplemented by the Specifications, and as Engineer may decide is appropriate under the circumstances.
 3. Contractor shall make written application to Engineer for review of a proposed substitute item of material or equipment that Contractor seeks to furnish or use. The application:
 - a. shall certify that the proposed substitute item will:
 - 1) perform adequately the functions and achieve the results called for by the general design,
 - 2) be similar in substance to that specified, and
 - 3) be suited to the same use as that specified.
 - b. will state:
 - 1) the extent, if any, to which the use of the proposed substitute item will necessitate a change in Contract Times,
 - 2) whether use of the proposed substitute item in the Work will require a change in any of the Contract Documents (or in the provisions of any other direct contract with Owner for other work on the Project) to adapt the design to the proposed substitute item, and
 - 3) whether incorporation or use of the proposed substitute item in connection with the Work is subject to payment of any license fee or royalty.
 - c. will identify:
 - 1) all variations of the proposed substitute item from that specified, and
 - 2) available engineering, sales, maintenance, repair, and replacement services.
 - d. shall contain an itemized estimate of all costs or credits that will result directly or indirectly from use of such substitute item, including but not

limited to changes in Contract Price, shared savings, costs of redesign, and claims of other contractors affected by any resulting change.

- B. *Engineer's Evaluation and Determination:* Engineer will be allowed a reasonable time to evaluate each substitute request, and to obtain comments and direction from Owner. Engineer may require Contractor to furnish additional data about the proposed substitute item. Engineer will be the sole judge of acceptability. No substitute will be ordered, furnished, installed, or utilized until Engineer's review is complete and Engineer determines that the proposed item is an acceptable substitute. Engineer's determination will be evidenced by a Field Order or a proposed Change Order accounting for the substitution itself and all related impacts, including changes in Contract Price or Contract Times. Engineer will advise Contractor in writing of any negative determination.
- C. *Special Guarantee:* Owner may require Contractor to furnish at Contractor's expense a special performance guarantee or other surety with respect to any substitute.
- D. *Reimbursement of Engineer's Cost:* Engineer will record Engineer's costs in evaluating a substitute proposed or submitted by Contractor. Whether or not Engineer approves a substitute so proposed or submitted by Contractor, Contractor shall reimburse Owner for the reasonable charges of Engineer for evaluating each such proposed substitute. Contractor shall also reimburse Owner for the reasonable charges of Engineer for making changes in the Contract Documents (or in the provisions of any other direct contract with Owner) resulting from the acceptance of each proposed substitute.
- E. *Contractor's Expense:* Contractor shall provide all data in support of any proposed substitute at Contractor's expense.
- F. *Effect of Engineer's Determination:* If Engineer approves the substitution request, Contractor shall execute the proposed Change Order and proceed with the substitution. The Engineer's denial of a substitution request shall be final and binding, and may not be reversed through an appeal under any provision of the Contract Documents. Contractor may challenge the scope of reimbursement costs imposed under Paragraph 7.05.D, by timely submittal of a Change Proposal.

7.06 *Concerning Subcontractors, Suppliers, and Others*

- A. Contractor may retain Subcontractors and Suppliers for the performance of parts of the Work. Such Subcontractors and Suppliers must be acceptable to Owner.
- B. Contractor shall retain specific Subcontractors, Suppliers, or other individuals or entities for the performance of designated parts of the Work if required by the Contract to do so.
- C. Subsequent to the submittal of Contractor's Bid or final negotiation of the terms of the Contract, Owner may not require Contractor to retain any Subcontractor, Supplier, or other individual or entity to furnish or perform any of the Work against which Contractor has reasonable objection.
- D. Prior to entry into any binding subcontract or purchase order, Contractor shall submit to Owner the identity of the proposed Subcontractor or Supplier (unless Owner has

already deemed such proposed Subcontractor or Supplier acceptable, during the bidding process or otherwise). Such proposed Subcontractor or Supplier shall be deemed acceptable to Owner unless Owner raises a substantive, reasonable objection within five days.

- E. Owner may require the replacement of any Subcontractor, Supplier, or other individual or entity retained by Contractor to perform any part of the Work. Owner also may require Contractor to retain specific replacements; provided, however, that Owner may not require a replacement to which Contractor has a reasonable objection. If Contractor has submitted the identity of certain Subcontractors, Suppliers, or other individuals or entities for acceptance by Owner, and Owner has accepted it (either in writing or by failing to make written objection thereto), then Owner may subsequently revoke the acceptance of any such Subcontractor, Supplier, or other individual or entity so identified solely on the basis of substantive, reasonable objection after due investigation. Contractor shall submit an acceptable replacement for the rejected Subcontractor, Supplier, or other individual or entity.
- F. If Owner requires the replacement of any Subcontractor, Supplier, or other individual or entity retained by Contractor to perform any part of the Work, then Contractor shall be entitled to an adjustment in Contract Price or Contract Times, or both, with respect to the replacement; and Contractor shall initiate a Change Proposal for such adjustment within 30 days of Owner's requirement of replacement.
- G. No acceptance by Owner of any such Subcontractor, Supplier, or other individual or entity, whether initially or as a replacement, shall constitute a waiver of the right of Owner to the completion of the Work in accordance with the Contract Documents.
- H. On a monthly basis Contractor shall submit to Engineer a complete list of all Subcontractors and Suppliers having a direct contract with Contractor, and of all other Subcontractors and Suppliers known to Contractor at the time of submittal.
- I. Contractor shall be fully responsible to Owner and Engineer for all acts and omissions of the Subcontractors, Suppliers, and other individuals or entities performing or furnishing any of the Work just as Contractor is responsible for Contractor's own acts and omissions.
- J. Contractor shall be solely responsible for scheduling and coordinating the work of Subcontractors, Suppliers, and all other individuals or entities performing or furnishing any of the Work.
- K. Contractor shall restrict all Subcontractors, Suppliers, and such other individuals or entities performing or furnishing any of the Work from communicating with Engineer or Owner, except through Contractor or in case of an emergency, or as otherwise expressly allowed herein.
- L. The divisions and sections of the Specifications and the identifications of any Drawings shall not control Contractor in dividing the Work among Subcontractors or Suppliers or delineating the Work to be performed by any specific trade.
- M. All Work performed for Contractor by a Subcontractor or Supplier shall be pursuant to an appropriate contractual agreement that specifically binds the Subcontractor or

Supplier to the applicable terms and conditions of the Contract Documents for the benefit of Owner and Engineer.

- N. Owner may furnish to any Subcontractor or Supplier, to the extent practicable, information about amounts paid to Contractor on account of Work performed for Contractor by the particular Subcontractor or Supplier.
- O. Nothing in the Contract Documents:
 - 1. shall create for the benefit of any such Subcontractor, Supplier, or other individual or entity any contractual relationship between Owner or Engineer and any such Subcontractor, Supplier, or other individual or entity; nor
 - 2. shall create any obligation on the part of Owner or Engineer to pay or to see to the payment of any money due any such Subcontractor, Supplier, or other individual or entity except as may otherwise be required by Laws and Regulations.

7.07 *Patent Fees and Royalties*

- A. Contractor shall pay all license fees and royalties and assume all costs incident to the use in the performance of the Work or the incorporation in the Work of any invention, design, process, product, or device which is the subject of patent rights or copyrights held by others. If a particular invention, design, process, product, or device is specified in the Contract Documents for use in the performance of the Work and if, to the actual knowledge of Owner or Engineer, its use is subject to patent rights or copyrights calling for the payment of any license fee or royalty to others, the existence of such rights shall be disclosed by Owner in the Contract Documents.
- B. To the fullest extent permitted by Laws and Regulations, Owner shall indemnify and hold harmless Contractor, and its officers, directors, members, partners, employees, agents, consultants, and subcontractors from and against all claims, costs, losses, and damages (including but not limited to all fees and charges of engineers, architects, attorneys, and other professionals, and all court or arbitration or other dispute resolution costs) arising out of or relating to any infringement of patent rights or copyrights incident to the use in the performance of the Work or resulting from the incorporation in the Work of any invention, design, process, product, or device specified in the Contract Documents, but not identified as being subject to payment of any license fee or royalty to others required by patent rights or copyrights.
- C. To the fullest extent permitted by Laws and Regulations, Contractor shall indemnify and hold harmless Owner and Engineer, and the officers, directors, members, partners, employees, agents, consultants and subcontractors of each and any of them from and against all claims, costs, losses, and damages (including but not limited to all fees and charges of engineers, architects, attorneys, and other professionals and all court or arbitration or other dispute resolution costs) arising out of or relating to any infringement of patent rights or copyrights incident to the use in the performance of the Work or resulting from the incorporation in the Work of any invention, design, process, product, or device not specified in the Contract Documents.

7.08 *Permits*

- A. Unless otherwise provided in the Contract Documents, Contractor shall obtain and pay for all construction permits and licenses. Owner shall assist Contractor, when necessary, in obtaining such permits and licenses. Contractor shall pay all governmental charges and inspection fees necessary for the prosecution of the Work which are applicable at the time of the submission of Contractor's Bid (or when Contractor became bound under a negotiated contract). Owner shall pay all charges of utility owners for connections for providing permanent service to the Work

7.09 *Taxes*

- A. Contractor shall pay all sales, consumer, use, and other similar taxes required to be paid by Contractor in accordance with the Laws and Regulations of the place of the Project which are applicable during the performance of the Work.

7.10 *Laws and Regulations*

- A. Contractor shall give all notices required by and shall comply with all Laws and Regulations applicable to the performance of the Work. Except where otherwise expressly required by applicable Laws and Regulations, neither Owner nor Engineer shall be responsible for monitoring Contractor's compliance with any Laws or Regulations.
- B. If Contractor performs any Work or takes any other action knowing or having reason to know that it is contrary to Laws or Regulations, Contractor shall bear all resulting costs and losses, and shall indemnify and hold harmless Owner and Engineer, and the officers, directors, members, partners, employees, agents, consultants, and subcontractors of each and any of them from and against all claims, costs, losses, and damages (including but not limited to all fees and charges of engineers, architects, attorneys, and other professionals and all court or arbitration or other dispute resolution costs) arising out of or relating to such Work or other action. It shall not be Contractor's responsibility to make certain that the Work described in the Contract Documents is in accordance with Laws and Regulations, but this shall not relieve Contractor of Contractor's obligations under Paragraph 3.03.
- C. Owner or Contractor may give notice to the other party of any changes after the submission of Contractor's Bid (or after the date when Contractor became bound under a negotiated contract) in Laws or Regulations having an effect on the cost or time of performance of the Work, including but not limited to changes in Laws or Regulations having an effect on procuring permits and on sales, use, value-added, consumption, and other similar taxes. If Owner and Contractor are unable to agree on entitlement to or on the amount or extent, if any, of any adjustment in Contract Price or Contract Times resulting from such changes, then within 30 days of such notice Contractor may submit a Change Proposal, or Owner may initiate a Claim.

7.11 *Record Documents*

- A. Contractor shall maintain in a safe place at the Site one printed record copy of all Drawings, Specifications, Addenda, Change Orders, Work Change Directives, Field Orders, written interpretations and clarifications, and approved Shop Drawings. Contractor shall keep such record documents in good order and annotate them to

show changes made during construction. These record documents, together with all approved Samples, will be available to Engineer for reference. Upon completion of the Work, Contractor shall deliver these record documents to Engineer.

7.12 *Safety and Protection*

- A. Contractor shall be solely responsible for initiating, maintaining, and supervising all safety precautions and programs in connection with the Work. Such responsibility does not relieve Subcontractors of their responsibility for the safety of persons or property in the performance of their work, nor for compliance with applicable safety Laws and Regulations. Contractor shall take all necessary precautions for the safety of, and shall provide the necessary protection to prevent damage, injury, or loss to:
 - 1. all persons on the Site or who may be affected by the Work;
 - 2. all the Work and materials and equipment to be incorporated therein, whether in storage on or off the Site; and
 - 3. other property at the Site or adjacent thereto, including trees, shrubs, lawns, walks, pavements, roadways, structures, other work in progress, utilities, and Underground Facilities not designated for removal, relocation, or replacement in the course of construction.
- B. Contractor shall comply with all applicable Laws and Regulations relating to the safety of persons or property, or to the protection of persons or property from damage, injury, or loss; and shall erect and maintain all necessary safeguards for such safety and protection. Contractor shall notify Owner; the owners of adjacent property, Underground Facilities, and other utilities; and other contractors and utility owners performing work at or adjacent to the Site, when prosecution of the Work may affect them, and shall cooperate with them in the protection, removal, relocation, and replacement of their property or work in progress.
- C. Contractor shall comply with the applicable requirements of Owner's safety programs, if any. The Supplementary Conditions identify any Owner's safety programs that are applicable to the Work.
- D. Contractor shall inform Owner and Engineer of the specific requirements of Contractor's safety program with which Owner's and Engineer's employees and representatives must comply while at the Site.
- E. All damage, injury, or loss to any property referred to in Paragraph 7.12.A.2 or 7.12.A.3 caused, directly or indirectly, in whole or in part, by Contractor, any Subcontractor, Supplier, or any other individual or entity directly or indirectly employed by any of them to perform any of the Work, or anyone for whose acts any of them may be liable, shall be remedied by Contractor at its expense (except damage or loss attributable to the fault of Drawings or Specifications or to the acts or omissions of Owner or Engineer or anyone employed by any of them, or anyone for whose acts any of them may be liable, and not attributable, directly or indirectly, in whole or in part, to the fault or negligence of Contractor or any Subcontractor, Supplier, or other individual or entity directly or indirectly employed by any of them).

- F. Contractor's duties and responsibilities for safety and protection shall continue until such time as all the Work is completed and Engineer has issued a notice to Owner and Contractor in accordance with Paragraph 15.06.B that the Work is acceptable (except as otherwise expressly provided in connection with Substantial Completion).
- G. Contractor's duties and responsibilities for safety and protection shall resume whenever Contractor or any Subcontractor or Supplier returns to the Site to fulfill warranty or correction obligations, or to conduct other tasks arising from the Contract Documents.

7.13 *Safety Representative*

- A. Contractor shall designate a qualified and experienced safety representative at the Site whose duties and responsibilities shall be the prevention of accidents and the maintaining and supervising of safety precautions and programs.

7.14 *Hazard Communication Programs*

- A. Contractor shall be responsible for coordinating any exchange of material safety data sheets or other hazard communication information required to be made available to or exchanged between or among employers at the Site in accordance with Laws or Regulations.

7.15 *Emergencies*

- A. In emergencies affecting the safety or protection of persons or the Work or property at the Site or adjacent thereto, Contractor is obligated to act to prevent threatened damage, injury, or loss. Contractor shall give Engineer prompt written notice if Contractor believes that any significant changes in the Work or variations from the Contract Documents have been caused thereby or are required as a result thereof. If Engineer determines that a change in the Contract Documents is required because of the action taken by Contractor in response to such an emergency, a Work Change Directive or Change Order will be issued.

7.16 *Shop Drawings, Samples, and Other Submittals*

A. *Shop Drawing and Sample Submittal Requirements:*

1. Before submitting a Shop Drawing or Sample, Contractor shall have:
 - a. reviewed and coordinated the Shop Drawing or Sample with other Shop Drawings and Samples and with the requirements of the Work and the Contract Documents;
 - b. determined and verified all field measurements, quantities, dimensions, specified performance and design criteria, installation requirements, materials, catalog numbers, and similar information with respect thereto;
 - c. determined and verified the suitability of all materials and equipment offered with respect to the indicated application, fabrication, shipping, handling, storage, assembly, and installation pertaining to the performance of the Work; and

- d. determined and verified all information relative to Contractor's responsibilities for means, methods, techniques, sequences, and procedures of construction, and safety precautions and programs incident thereto.
 2. Each submittal shall bear a stamp or specific written certification that Contractor has satisfied Contractor's obligations under the Contract Documents with respect to Contractor's review of that submittal, and that Contractor approves the submittal.
 3. With each submittal, Contractor shall give Engineer specific written notice of any variations that the Shop Drawing or Sample may have from the requirements of the Contract Documents. This notice shall be set forth in a written communication separate from the Shop Drawings or Sample submittal; and, in addition, in the case of Shop Drawings by a specific notation made on each Shop Drawing submitted to Engineer for review and approval of each such variation.
- B. *Submittal Procedures for Shop Drawings and Samples:* Contractor shall submit Shop Drawings and Samples to Engineer for review and approval in accordance with the accepted Schedule of Submittals. Each submittal will be identified as Engineer may require.
1. *Shop Drawings:*
 - a. Contractor shall submit the number of copies required in the Specifications.
 - b. Data shown on the Shop Drawings will be complete with respect to quantities, dimensions, specified performance and design criteria, materials, and similar data to show Engineer the services, materials, and equipment Contractor proposes to provide and to enable Engineer to review the information for the limited purposes required by Paragraph 7.16.D.
 2. *Samples:*
 - a. Contractor shall submit the number of Samples required in the Specifications.
 - b. Contractor shall clearly identify each Sample as to material, Supplier, pertinent data such as catalog numbers, the use for which intended and other data as Engineer may require to enable Engineer to review the submittal for the limited purposes required by Paragraph 7.16.D.
 3. Where a Shop Drawing or Sample is required by the Contract Documents or the Schedule of Submittals, any related Work performed prior to Engineer's review and approval of the pertinent submittal will be at the sole expense and responsibility of Contractor.
- C. *Other Submittals:* Contractor shall submit other submittals to Engineer in accordance with the accepted Schedule of Submittals, and pursuant to the applicable terms of the Specifications.

D. *Engineer's Review:*

1. Engineer will provide timely review of Shop Drawings and Samples in accordance with the Schedule of Submittals acceptable to Engineer. Engineer's review and approval will be only to determine if the items covered by the submittals will, after installation or incorporation in the Work, conform to the information given in the Contract Documents and be compatible with the design concept of the completed Project as a functioning whole as indicated by the Contract Documents.
2. Engineer's review and approval will not extend to means, methods, techniques, sequences, or procedures of construction or to safety precautions or programs incident thereto.
3. Engineer's review and approval of a separate item as such will not indicate approval of the assembly in which the item functions.
4. Engineer's review and approval of a Shop Drawing or Sample shall not relieve Contractor from responsibility for any variation from the requirements of the Contract Documents unless Contractor has complied with the requirements of Paragraph 7.16.A.3 and Engineer has given written approval of each such variation by specific written notation thereof incorporated in or accompanying the Shop Drawing or Sample. Engineer will document any such approved variation from the requirements of the Contract Documents in a Field Order.
5. Engineer's review and approval of a Shop Drawing or Sample shall not relieve Contractor from responsibility for complying with the requirements of Paragraph 7.16.A and B.
6. Engineer's review and approval of a Shop Drawing or Sample, or of a variation from the requirements of the Contract Documents, shall not, under any circumstances, change the Contract Times or Contract Price, unless such changes are included in a Change Order.
7. Neither Engineer's receipt, review, acceptance or approval of a Shop Drawing, Sample, or other submittal shall result in such item becoming a Contract Document.
8. Contractor shall perform the Work in compliance with the requirements and commitments set forth in approved Shop Drawings and Samples, subject to the provisions of Paragraph 7.16.D.4.

E. *Resubmittal Procedures:*

1. Contractor shall make corrections required by Engineer and shall return the required number of corrected copies of Shop Drawings and submit, as required, new Samples for review and approval. Contractor shall direct specific attention in writing to revisions other than the corrections called for by Engineer on previous submittals.
2. Contractor shall furnish required submittals with sufficient information and accuracy to obtain required approval of an item with no more than three submittals. Engineer will record Engineer's time for reviewing a fourth or

subsequent submittal of a Shop Drawings, sample, or other item requiring approval, and Contractor shall be responsible for Engineer's charges to Owner for such time. Owner may impose a set-off against payments due to Contractor to secure reimbursement for such charges.

3. If Contractor requests a change of a previously approved submittal item, Contractor shall be responsible for Engineer's charges to Owner for its review time, and Owner may impose a set-off against payments due to Contractor to secure reimbursement for such charges, unless the need for such change is beyond the control of Contractor.

7.17 *Contractor's General Warranty and Guarantee*

- A. Contractor warrants and guarantees to Owner that all Work will be in accordance with the Contract Documents and will not be defective. Engineer and its officers, directors, members, partners, employees, agents, consultants, and subcontractors shall be entitled to rely on Contractor's warranty and guarantee.
- B. Contractor's warranty and guarantee hereunder excludes defects or damage caused by:
 1. abuse, modification, or improper maintenance or operation by persons other than Contractor, Subcontractors, Suppliers, or any other individual or entity for whom Contractor is responsible; or
 2. normal wear and tear under normal usage.
- C. Contractor's obligation to perform and complete the Work in accordance with the Contract Documents shall be absolute. None of the following will constitute an acceptance of Work that is not in accordance with the Contract Documents or a release of Contractor's obligation to perform the Work in accordance with the Contract Documents:
 1. observations by Engineer;
 2. recommendation by Engineer or payment by Owner of any progress or final payment;
 3. the issuance of a certificate of Substantial Completion by Engineer or any payment related thereto by Owner;
 4. use or occupancy of the Work or any part thereof by Owner;
 5. any review and approval of a Shop Drawing or Sample submittal;
 6. the issuance of a notice of acceptability by Engineer;
 7. any inspection, test, or approval by others; or
 8. any correction of defective Work by Owner.
- D. If the Contract requires the Contractor to accept the assignment of a contract entered into by Owner, then the specific warranties, guarantees, and correction obligations contained in the assigned contract shall govern with respect to Contractor's performance obligations to Owner for the Work described in the assigned contract.

7.18 *Indemnification*

- A. To the fullest extent permitted by Laws and Regulations, and in addition to any other obligations of Contractor under the Contract or otherwise, Contractor shall indemnify and hold harmless Owner and Engineer, and the officers, directors, members, partners, employees, agents, consultants and subcontractors of each and any of them from and against all claims, costs, losses, and damages (including but not limited to all fees and charges of engineers, architects, attorneys, and other professionals and all court or arbitration or other dispute resolution costs) arising out of or relating to the performance of the Work, provided that any such claim, cost, loss, or damage is attributable to bodily injury, sickness, disease, or death, or to injury to or destruction of tangible property (other than the Work itself), including the loss of use resulting therefrom but only to the extent caused by any negligent act or omission of Contractor, any Subcontractor, any Supplier, or any individual or entity directly or indirectly employed by any of them to perform any of the Work or anyone for whose acts any of them may be liable.
- B. In any and all claims against Owner or Engineer or any of their officers, directors, members, partners, employees, agents, consultants, or subcontractors by any employee (or the survivor or personal representative of such employee) of Contractor, any Subcontractor, any Supplier, or any individual or entity directly or indirectly employed by any of them to perform any of the Work, or anyone for whose acts any of them may be liable, the indemnification obligation under Paragraph 7.18.A shall not be limited in any way by any limitation on the amount or type of damages, compensation, or benefits payable by or for Contractor or any such Subcontractor, Supplier, or other individual or entity under workers' compensation acts, disability benefit acts, or other employee benefit acts.
- C. The indemnification obligations of Contractor under Paragraph 7.18.A shall not extend to the liability of Engineer and Engineer's officers, directors, members, partners, employees, agents, consultants and subcontractors arising out of:
 - 1. the preparation or approval of, or the failure to prepare or approve maps, Drawings, opinions, reports, surveys, Change Orders, designs, or Specifications; or
 - 2. giving directions or instructions, or failing to give them, if that is the primary cause of the injury or damage.

7.19 *Delegation of Professional Design Services*

- A. Contractor will not be required to provide professional design services unless such services are specifically required by the Contract Documents for a portion of the Work or unless such services are required to carry out Contractor's responsibilities for construction means, methods, techniques, sequences and procedures. Contractor shall not be required to provide professional services in violation of applicable Laws and Regulations.
- B. If professional design services or certifications by a design professional related to systems, materials, or equipment are specifically required of Contractor by the Contract Documents, Owner and Engineer will specify all performance and design

criteria that such services must satisfy. Contractor shall cause such services or certifications to be provided by a properly licensed professional, whose signature and seal shall appear on all drawings, calculations, specifications, certifications, and other submittals prepared by such professional. Shop Drawings and other submittals related to the Work designed or certified by such professional, if prepared by others, shall bear such professional's written approval when submitted to Engineer.

- C. Owner and Engineer shall be entitled to rely upon the adequacy, accuracy, and completeness of the services, certifications, or approvals performed by such design professionals, provided Owner and Engineer have specified to Contractor all performance and design criteria that such services must satisfy.
- D. Pursuant to this paragraph, Engineer's review and approval of design calculations and design drawings will be only for the limited purpose of checking for conformance with performance and design criteria given and the design concept expressed in the Contract Documents. Engineer's review and approval of Shop Drawings and other submittals (except design calculations and design drawings) will be only for the purpose stated in Paragraph 7.16.D.1.
- E. Contractor shall not be responsible for the adequacy of the performance or design criteria specified by Owner or Engineer.

ARTICLE 8 – OTHER WORK AT THE SITE

8.01 *Other Work*

- A. In addition to and apart from the Work under the Contract Documents, the Owner may perform other work at or adjacent to the Site. Such other work may be performed by Owner's employees, or through contracts between the Owner and third parties. Owner may also arrange to have third-party utility owners perform work on their utilities and facilities at or adjacent to the Site.
- B. If Owner performs other work at or adjacent to the Site with Owner's employees, or through contracts for such other work, then Owner shall give Contractor written notice thereof prior to starting any such other work. If Owner has advance information regarding the start of any utility work at or adjacent to the Site, Owner shall provide such information to Contractor.
- C. Contractor shall afford each other contractor that performs such other work, each utility owner performing other work, and Owner, if Owner is performing other work with Owner's employees, proper and safe access to the Site, and provide a reasonable opportunity for the introduction and storage of materials and equipment and the execution of such other work. Contractor shall do all cutting, fitting, and patching of the Work that may be required to properly connect or otherwise make its several parts come together and properly integrate with such other work. Contractor shall not endanger any work of others by cutting, excavating, or otherwise altering such work; provided, however, that Contractor may cut or alter others' work with the written consent of Engineer and the others whose work will be affected.
- D. If the proper execution or results of any part of Contractor's Work depends upon work performed by others under this Article 8, Contractor shall inspect such other

work and promptly report to Engineer in writing any delays, defects, or deficiencies in such other work that render it unavailable or unsuitable for the proper execution and results of Contractor's Work. Contractor's failure to so report will constitute an acceptance of such other work as fit and proper for integration with Contractor's Work except for latent defects and deficiencies in such other work.

8.02 *Coordination*

- A. If Owner intends to contract with others for the performance of other work at or adjacent to the Site, to perform other work at or adjacent to the Site with Owner's employees, or to arrange to have utility owners perform work at or adjacent to the Site, the following will be set forth in the Supplementary Conditions or provided to Contractor prior to the start of any such other work:
 - 1. the identity of the individual or entity that will have authority and responsibility for coordination of the activities among the various contractors;
 - 2. an itemization of the specific matters to be covered by such authority and responsibility; and
 - 3. the extent of such authority and responsibilities.
- B. Unless otherwise provided in the Supplementary Conditions, Owner shall have sole authority and responsibility for such coordination.

8.03 *Legal Relationships*

- A. If, in the course of performing other work at or adjacent to the Site for Owner, the Owner's employees, any other contractor working for Owner, or any utility owner for whom the Owner is responsible causes damage to the Work or to the property of Contractor or its Subcontractors, or delays, disrupts, interferes with, or increases the scope or cost of the performance of the Work, through actions or inaction, then Contractor shall be entitled to an equitable adjustment in the Contract Price or the Contract Times, or both. Contractor must submit any Change Proposal seeking an equitable adjustment in the Contract Price or the Contract Times under this paragraph within 30 days of the damaging, delaying, disrupting, or interfering event. The entitlement to, and extent of, any such equitable adjustment shall take into account information (if any) regarding such other work that was provided to Contractor in the Contract Documents prior to the submittal of the Bid or the final negotiation of the terms of the Contract. When applicable, any such equitable adjustment in Contract Price shall be conditioned on Contractor assigning to Owner all Contractor's rights against such other contractor or utility owner with respect to the damage, delay, disruption, or interference that is the subject of the adjustment. Contractor's entitlement to an adjustment of the Contract Times is conditioned on such adjustment being essential to Contractor's ability to complete the Work within the Contract Times.
- B. Contractor shall take reasonable and customary measures to avoid damaging, delaying, disrupting, or interfering with the work of Owner, any other contractor, or any utility owner performing other work at or adjacent to the Site. If Contractor fails to take such measures and as a result damages, delays, disrupts, or interferes with the work of any such other contractor or utility owner, then Owner may impose a set-off

against payments due to Contractor, and assign to such other contractor or utility owner the Owner's contractual rights against Contractor with respect to the breach of the obligations set forth in this paragraph.

- C. When Owner is performing other work at or adjacent to the Site with Owner's employees, Contractor shall be liable to Owner for damage to such other work, and for the reasonable direct delay, disruption, and interference costs incurred by Owner as a result of Contractor's failure to take reasonable and customary measures with respect to Owner's other work. In response to such damage, delay, disruption, or interference, Owner may impose a set-off against payments due to Contractor.
- D. If Contractor damages, delays, disrupts, or interferes with the work of any other contractor, or any utility owner performing other work at or adjacent to the Site, through Contractor's failure to take reasonable and customary measures to avoid such impacts, or if any claim arising out of Contractor's actions, inactions, or negligence in performance of the Work at or adjacent to the Site is made by any such other contractor or utility owner against Contractor, Owner, or Engineer, then Contractor shall (1) promptly attempt to settle the claim as to all parties through negotiations with such other contractor or utility owner, or otherwise resolve the claim by arbitration or other dispute resolution proceeding or at law, and (2) indemnify and hold harmless Owner and Engineer, and the officers, directors, members, partners, employees, agents, consultants and subcontractors of each and any of them from and against any such claims, and against all costs, losses, and damages (including but not limited to all fees and charges of engineers, architects, attorneys, and other professionals and all court or arbitration or other dispute resolution costs) arising out of or relating to such damage, delay, disruption, or interference.

ARTICLE 9 – OWNER'S RESPONSIBILITIES

9.01 *Communications to Contractor*

- A. Except as otherwise provided in these General Conditions, Owner shall issue all communications to Contractor through Engineer.

9.02 *Replacement of Engineer*

- A. Owner may at its discretion appoint an engineer to replace Engineer, provided Contractor makes no reasonable objection to the replacement engineer. The replacement engineer's status under the Contract Documents shall be that of the former Engineer.

9.03 *Furnish Data*

- A. Owner shall promptly furnish the data required of Owner under the Contract Documents.

9.04 *Pay When Due*

- A. Owner shall make payments to Contractor when they are due as provided in the Agreement.

- 9.05 *Lands and Easements; Reports, Tests, and Drawings*
- A. Owner's duties with respect to providing lands and easements are set forth in Paragraph 5.01.
 - B. Owner's duties with respect to providing engineering surveys to establish reference points are set forth in Paragraph 4.03.
 - C. Article 5 refers to Owner's identifying and making available to Contractor copies of reports of explorations and tests of conditions at the Site, and drawings of physical conditions relating to existing surface or subsurface structures at the Site.
- 9.06 *Insurance*
- A. Owner's responsibilities, if any, with respect to purchasing and maintaining liability and property insurance are set forth in Article 6.
- 9.07 *Change Orders*
- A. Owner's responsibilities with respect to Change Orders are set forth in Article 11.
- 9.08 *Inspections, Tests, and Approvals*
- A. Owner's responsibility with respect to certain inspections, tests, and approvals is set forth in Paragraph 14.02.B.
- 9.09 *Limitations on Owner's Responsibilities*
- A. The Owner shall not supervise, direct, or have control or authority over, nor be responsible for, Contractor's means, methods, techniques, sequences, or procedures of construction, or the safety precautions and programs incident thereto, or for any failure of Contractor to comply with Laws and Regulations applicable to the performance of the Work. Owner will not be responsible for Contractor's failure to perform the Work in accordance with the Contract Documents.
- 9.10 *Undisclosed Hazardous Environmental Condition*
- A. Owner's responsibility in respect to an undisclosed Hazardous Environmental Condition is set forth in Paragraph 5.06.
- 9.11 *Evidence of Financial Arrangements*
- A. Upon request of Contractor, Owner shall furnish Contractor reasonable evidence that financial arrangements have been made to satisfy Owner's obligations under the Contract Documents (including obligations under proposed changes in the Work).
- 9.12 *Safety Programs*
- A. While at the Site, Owner's employees and representatives shall comply with the specific applicable requirements of Contractor's safety programs of which Owner has been informed.
 - B. Owner shall furnish copies of any applicable Owner safety programs to Contractor.

ARTICLE 10 – ENGINEER’S STATUS DURING CONSTRUCTION

10.01 *Owner’s Representative*

- A. Engineer will be Owner’s representative during the construction period. The duties and responsibilities and the limitations of authority of Engineer as Owner’s representative during construction are set forth in the Contract.

10.02 *Visits to Site*

- A. Engineer will make visits to the Site at intervals appropriate to the various stages of construction as Engineer deems necessary in order to observe as an experienced and qualified design professional the progress that has been made and the quality of the various aspects of Contractor’s executed Work. Based on information obtained during such visits and observations, Engineer, for the benefit of Owner, will determine, in general, if the Work is proceeding in accordance with the Contract Documents. Engineer will not be required to make exhaustive or continuous inspections on the Site to check the quality or quantity of the Work. Engineer’s efforts will be directed toward providing for Owner a greater degree of confidence that the completed Work will conform generally to the Contract Documents. On the basis of such visits and observations, Engineer will keep Owner informed of the progress of the Work and will endeavor to guard Owner against defective Work.
- B. Engineer’s visits and observations are subject to all the limitations on Engineer’s authority and responsibility set forth in Paragraph 10.08. Particularly, but without limitation, during or as a result of Engineer’s visits or observations of Contractor’s Work, Engineer will not supervise, direct, control, or have authority over or be responsible for Contractor’s means, methods, techniques, sequences, or procedures of construction, or the safety precautions and programs incident thereto, or for any failure of Contractor to comply with Laws and Regulations applicable to the performance of the Work.

10.03 *Project Representative*

- A. If Owner and Engineer have agreed that Engineer will furnish a Resident Project Representative to represent Engineer at the Site and assist Engineer in observing the progress and quality of the Work, then the authority and responsibilities of any such Resident Project Representative will be as provided in the Supplementary Conditions, and limitations on the responsibilities thereof will be as provided in Paragraph 10.08. If Owner designates another representative or agent to represent Owner at the Site who is not Engineer’s consultant, agent, or employee, the responsibilities and authority and limitations thereon of such other individual or entity will be as provided in the Supplementary Conditions.

10.04 *Rejecting Defective Work*

- A. Engineer has the authority to reject Work in accordance with Article 14.

10.05 *Shop Drawings, Change Orders and Payments*

- A. Engineer’s authority, and limitations thereof, as to Shop Drawings and Samples, are set forth in Paragraph 7.16.

- B. Engineer's authority, and limitations thereof, as to design calculations and design drawings submitted in response to a delegation of professional design services, if any, are set forth in Paragraph 7.19.
- C. Engineer's authority as to Change Orders is set forth in Article 11.
- D. Engineer's authority as to Applications for Payment is set forth in Article 15.

10.06 *Determinations for Unit Price Work*

- A. Engineer will determine the actual quantities and classifications of Unit Price Work performed by Contractor as set forth in Paragraph 13.03.

10.07 *Decisions on Requirements of Contract Documents and Acceptability of Work*

- A. Engineer will render decisions regarding the requirements of the Contract Documents, and judge the acceptability of the Work, pursuant to the specific procedures set forth herein for initial interpretations, Change Proposals, and acceptance of the Work. In rendering such decisions and judgments, Engineer will not show partiality to Owner or Contractor, and will not be liable to Owner, Contractor, or others in connection with any proceedings, interpretations, decisions, or judgments conducted or rendered in good faith.

10.08 *Limitations on Engineer's Authority and Responsibilities*

- A. Neither Engineer's authority or responsibility under this Article 10 or under any other provision of the Contract, nor any decision made by Engineer in good faith either to exercise or not exercise such authority or responsibility or the undertaking, exercise, or performance of any authority or responsibility by Engineer, shall create, impose, or give rise to any duty in contract, tort, or otherwise owed by Engineer to Contractor, any Subcontractor, any Supplier, any other individual or entity, or to any surety for or employee or agent of any of them.
- B. Engineer will not supervise, direct, control, or have authority over or be responsible for Contractor's means, methods, techniques, sequences, or procedures of construction, or the safety precautions and programs incident thereto, or for any failure of Contractor to comply with Laws and Regulations applicable to the performance of the Work. Engineer will not be responsible for Contractor's failure to perform the Work in accordance with the Contract Documents.
- C. Engineer will not be responsible for the acts or omissions of Contractor or of any Subcontractor, any Supplier, or of any other individual or entity performing any of the Work.
- D. Engineer's review of the final Application for Payment and accompanying documentation and all maintenance and operating instructions, schedules, guarantees, bonds, certificates of inspection, tests and approvals, and other documentation required to be delivered by Paragraph 15.06.A will only be to determine generally that their content complies with the requirements of, and in the case of certificates of inspections, tests, and approvals, that the results certified indicate compliance with the Contract Documents.

- E. The limitations upon authority and responsibility set forth in this Paragraph 10.08 shall also apply to the Resident Project Representative, if any.

10.09 *Compliance with Safety Program*

- A. While at the Site, Engineer's employees and representatives will comply with the specific applicable requirements of Owner's and Contractor's safety programs (if any) of which Engineer has been informed.

ARTICLE 11 – AMENDING THE CONTRACT DOCUMENTS; CHANGES IN THE WORK

11.01 *Amending and Supplementing Contract Documents*

- A. The Contract Documents may be amended or supplemented by a Change Order, a Work Change Directive, or a Field Order.

- 1. *Change Orders:*

- a. If an amendment or supplement to the Contract Documents includes a change in the Contract Price or the Contract Times, such amendment or supplement must be set forth in a Change Order. A Change Order also may be used to establish amendments and supplements of the Contract Documents that do not affect the Contract Price or Contract Times.
- b. Owner and Contractor may amend those terms and conditions of the Contract Documents that do not involve (1) the performance or acceptability of the Work, (2) the design (as set forth in the Drawings, Specifications, or otherwise), or (3) other engineering or technical matters, without the recommendation of the Engineer. Such an amendment shall be set forth in a Change Order.

- 2. *Work Change Directives:* A Work Change Directive will not change the Contract Price or the Contract Times but is evidence that the parties expect that the modification ordered or documented by a Work Change Directive will be incorporated in a subsequently issued Change Order, following negotiations by the parties as to the Work Change Directive's effect, if any, on the Contract Price and Contract Times; or, if negotiations are unsuccessful, by a determination under the terms of the Contract Documents governing adjustments, expressly including Paragraph 11.04 regarding change of Contract Price. Contractor must submit any Change Proposal seeking an adjustment of the Contract Price or the Contract Times, or both, no later than 30 days after the completion of the Work set out in the Work Change Directive. Owner must submit any Claim seeking an adjustment of the Contract Price or the Contract Times, or both, no later than 60 days after issuance of the Work Change Directive.

- 3. *Field Orders:* Engineer may authorize minor changes in the Work if the changes do not involve an adjustment in the Contract Price or the Contract Times and are compatible with the design concept of the completed Project as a functioning whole as indicated by the Contract Documents. Such changes will be

accomplished by a Field Order and will be binding on Owner and also on Contractor, which shall perform the Work involved promptly. If Contractor believes that a Field Order justifies an adjustment in the Contract Price or Contract Times, or both, then before proceeding with the Work at issue, Contractor shall submit a Change Proposal as provided herein.

11.02 *Owner-Authorized Changes in the Work*

- A. Without invalidating the Contract and without notice to any surety, Owner may, at any time or from time to time, order additions, deletions, or revisions in the Work. Such changes shall be supported by Engineer's recommendation, to the extent the change involves the design (as set forth in the Drawings, Specifications, or otherwise), or other engineering or technical matters. Such changes may be accomplished by a Change Order, if Owner and Contractor have agreed as to the effect, if any, of the changes on Contract Times or Contract Price; or by a Work Change Directive. Upon receipt of any such document, Contractor shall promptly proceed with the Work involved; or, in the case of a deletion in the Work, promptly cease construction activities with respect to such deleted Work. Added or revised Work shall be performed under the applicable conditions of the Contract Documents. Nothing in this paragraph shall obligate Contractor to undertake work that Contractor reasonably concludes cannot be performed in a manner consistent with Contractor's safety obligations under the Contract Documents or Laws and Regulations.

11.03 *Unauthorized Changes in the Work*

- A. Contractor shall not be entitled to an increase in the Contract Price or an extension of the Contract Times with respect to any work performed that is not required by the Contract Documents, as amended, modified, or supplemented, except in the case of an emergency as provided in Paragraph 7.15 or in the case of uncovering Work as provided in Paragraph 14.05.

11.04 *Change of Contract Price*

- A. The Contract Price may only be changed by a Change Order. Any Change Proposal for an adjustment in the Contract Price shall comply with the provisions of Paragraph 11.06. Any Claim for an adjustment of Contract Price shall comply with the provisions of Article 12.
- B. An adjustment in the Contract Price will be determined as follows:
1. where the Work involved is covered by unit prices contained in the Contract Documents, then by application of such unit prices to the quantities of the items involved (subject to the provisions of Paragraph 13.03); or
 2. where the Work involved is not covered by unit prices contained in the Contract Documents, then by a mutually agreed lump sum (which may include an allowance for overhead and profit not necessarily in accordance with Paragraph 11.04.C.2); or
 3. where the Work involved is not covered by unit prices contained in the Contract Documents and the parties do not reach mutual agreement to a lump sum, then on the basis of the Cost of the Work (determined as provided in Paragraph

13.01) plus a Contractor's fee for overhead and profit (determined as provided in Paragraph 11.04.C).

C. *Contractor's Fee*: When applicable, the Contractor's fee for overhead and profit shall be determined as follows:

1. a mutually acceptable fixed fee; or
2. if a fixed fee is not agreed upon, then a fee based on the following percentages of the various portions of the Cost of the Work:
 - a. for costs incurred under Paragraphs 13.01.B.1 and 13.01.B.2, the Contractor's fee shall be 15 percent;
 - b. for costs incurred under Paragraph 13.01.B.3, the Contractor's fee shall be five percent;
 - c. where one or more tiers of subcontracts are on the basis of Cost of the Work plus a fee and no fixed fee is agreed upon, the intent of Paragraphs 11.04.C.2.a and 11.04.C.2.b is that the Contractor's fee shall be based on: (1) a fee of 15 percent of the costs incurred under Paragraphs 13.01.A.1 and 13.01.A.2 by the Subcontractor that actually performs the Work, at whatever tier, and (2) with respect to Contractor itself and to any Subcontractors of a tier higher than that of the Subcontractor that actually performs the Work, a fee of five percent of the amount (fee plus underlying costs incurred) attributable to the next lower tier Subcontractor; provided, however, that for any such subcontracted work the maximum total fee to be paid by Owner shall be no greater than 27 percent of the costs incurred by the Subcontractor that actually performs the work;
 - d. no fee shall be payable on the basis of costs itemized under Paragraphs 13.01.B.4, 13.01.B.5, and 13.01.C;
 - e. the amount of credit to be allowed by Contractor to Owner for any change which results in a net decrease in cost will be the amount of the actual net decrease in cost plus a deduction in Contractor's fee by an amount equal to five percent of such net decrease; and
 - f. when both additions and credits are involved in any one change, the adjustment in Contractor's fee shall be computed on the basis of the net change in accordance with Paragraphs 11.04.C.2.a through 11.04.C.2.e, inclusive.

11.05 *Change of Contract Times*

- A. The Contract Times may only be changed by a Change Order. Any Change Proposal for an adjustment in the Contract Times shall comply with the provisions of Paragraph 11.06. Any Claim for an adjustment in the Contract Times shall comply with the provisions of Article 12.
- B. An adjustment of the Contract Times shall be subject to the limitations set forth in Paragraph 4.05, concerning delays in Contractor's progress.

11.06 *Change Proposals*

- A. Contractor shall submit a Change Proposal to Engineer to request an adjustment in the Contract Times or Contract Price; appeal an initial decision by Engineer concerning the requirements of the Contract Documents or relating to the acceptability of the Work under the Contract Documents; contest a set-off against payment due; or seek other relief under the Contract. The Change Proposal shall specify any proposed change in Contract Times or Contract Price, or both, or other proposed relief, and explain the reason for the proposed change, with citations to any governing or applicable provisions of the Contract Documents.
1. *Procedures*: Contractor shall submit each Change Proposal to Engineer promptly (but in no event later than 30 days) after the start of the event giving rise thereto, or after such initial decision. The Contractor shall submit supporting data, including the proposed change in Contract Price or Contract Time (if any), to the Engineer and Owner within 15 days after the submittal of the Change Proposal. The supporting data shall be accompanied by a written statement that the supporting data are accurate and complete, and that any requested time or price adjustment is the entire adjustment to which Contractor believes it is entitled as a result of said event. Engineer will advise Owner regarding the Change Proposal, and consider any comments or response from Owner regarding the Change Proposal.
 2. *Engineer's Action*: Engineer will review each Change Proposal and, within 30 days after receipt of the Contractor's supporting data, either deny the Change Proposal in whole, approve it in whole, or deny it in part and approve it in part. Such actions shall be in writing, with a copy provided to Owner and Contractor. If Engineer does not take action on the Change Proposal within 30 days, then either Owner or Contractor may at any time thereafter submit a letter to the other party indicating that as a result of Engineer's inaction the Change Proposal is deemed denied, thereby commencing the time for appeal of the denial under Article 12.
 3. *Binding Decision*: Engineer's decision will be final and binding upon Owner and Contractor, unless Owner or Contractor appeals the decision by filing a Claim under Article 12.
- B. *Resolution of Certain Change Proposals*: If the Change Proposal does not involve the design (as set forth in the Drawings, Specifications, or otherwise), the acceptability of the Work, or other engineering or technical matters, then Engineer will notify the parties that the Engineer is unable to resolve the Change Proposal. For purposes of further resolution of such a Change Proposal, such notice shall be deemed a denial, and Contractor may choose to seek resolution under the terms of Article 12.

11.07 *Execution of Change Orders*

- A. Owner and Contractor shall execute appropriate Change Orders covering:
1. changes in the Contract Price or Contract Times which are agreed to by the parties, including any undisputed sum or amount of time for Work actually performed in accordance with a Work Change Directive;
 2. changes in Contract Price resulting from an Owner set-off, unless Contractor has duly contested such set-off;
 3. changes in the Work which are: (a) ordered by Owner pursuant to Paragraph 11.02, (b) required because of Owner's acceptance of defective Work under Paragraph 14.04 or Owner's correction of defective Work under Paragraph 14.07, or (c) agreed to by the parties, subject to the need for Engineer's recommendation if the change in the Work involves the design (as set forth in the Drawings, Specifications, or otherwise), or other engineering or technical matters; and
 4. changes in the Contract Price or Contract Times, or other changes, which embody the substance of any final and binding results under Paragraph 11.06, or Article 12.
- B. If Owner or Contractor refuses to execute a Change Order that is required to be executed under the terms of this Paragraph 11.07, it shall be deemed to be of full force and effect, as if fully executed.

11.08 *Notification to Surety*

- A. If the provisions of any bond require notice to be given to a surety of any change affecting the general scope of the Work or the provisions of the Contract Documents (including, but not limited to, Contract Price or Contract Times), the giving of any such notice will be Contractor's responsibility. The amount of each applicable bond will be adjusted to reflect the effect of any such change.

ARTICLE 12 – CLAIMS

12.01 *Claims*

- A. *Claims Process*: The following disputes between Owner and Contractor shall be submitted to the Claims process set forth in this Article:
1. Appeals by Owner or Contractor of Engineer's decisions regarding Change Proposals;
 2. Owner demands for adjustments in the Contract Price or Contract Times, or other relief under the Contract Documents; and
 3. Disputes that Engineer has been unable to address because they do not involve the design (as set forth in the Drawings, Specifications, or otherwise), the acceptability of the Work, or other engineering or technical matters.
- B. *Submittal of Claim*: The party submitting a Claim shall deliver it directly to the other party to the Contract promptly (but in no event later than 30 days) after the start of

the event giving rise thereto; in the case of appeals regarding Change Proposals within 30 days of the decision under appeal. The party submitting the Claim shall also furnish a copy to the Engineer, for its information only. The responsibility to substantiate a Claim shall rest with the party making the Claim. In the case of a Claim by Contractor seeking an increase in the Contract Times or Contract Price, or both, Contractor shall certify that the Claim is made in good faith, that the supporting data are accurate and complete, and that to the best of Contractor's knowledge and belief the amount of time or money requested accurately reflects the full amount to which Contractor is entitled.

- C. *Review and Resolution:* The party receiving a Claim shall review it thoroughly, giving full consideration to its merits. The two parties shall seek to resolve the Claim through the exchange of information and direct negotiations. The parties may extend the time for resolving the Claim by mutual agreement. All actions taken on a Claim shall be stated in writing and submitted to the other party, with a copy to Engineer.
- D. *Mediation:*
 - 1. At any time after initiation of a Claim, Owner and Contractor may mutually agree to mediation of the underlying dispute. The agreement to mediate shall stay the Claim submittal and response process.
 - 2. If Owner and Contractor agree to mediation, then after 60 days from such agreement, either Owner or Contractor may unilaterally terminate the mediation process, and the Claim submittal and decision process shall resume as of the date of the termination. If the mediation proceeds but is unsuccessful in resolving the dispute, the Claim submittal and decision process shall resume as of the date of the conclusion of the mediation, as determined by the mediator.
 - 3. Owner and Contractor shall each pay one-half of the mediator's fees and costs.
- E. *Partial Approval:* If the party receiving a Claim approves the Claim in part and denies it in part, such action shall be final and binding unless within 30 days of such action the other party invokes the procedure set forth in Article 17 for final resolution of disputes.
- F. *Denial of Claim:* If efforts to resolve a Claim are not successful, the party receiving the Claim may deny it by giving written notice of denial to the other party. If the receiving party does not take action on the Claim within 90 days, then either Owner or Contractor may at any time thereafter submit a letter to the other party indicating that as a result of the inaction, the Claim is deemed denied, thereby commencing the time for appeal of the denial. A denial of the Claim shall be final and binding unless within 30 days of the denial the other party invokes the procedure set forth in Article 17 for the final resolution of disputes.
- G. *Final and Binding Results:* If the parties reach a mutual agreement regarding a Claim, whether through approval of the Claim, direct negotiations, mediation, or otherwise; or if a Claim is approved in part and denied in part, or denied in full, and such actions become final and binding; then the results of the agreement or action on the Claim shall be incorporated in a Change Order to the extent they affect the Contract, including the Work, the Contract Times, or the Contract Price.

ARTICLE 13 – COST OF THE WORK; ALLOWANCES; UNIT PRICE WORK

13.01 *Cost of the Work*

- A. *Purposes for Determination of Cost of the Work:* The term Cost of the Work means the sum of all costs necessary for the proper performance of the Work at issue, as further defined below. The provisions of this Paragraph 13.01 are used for two distinct purposes:
1. To determine Cost of the Work when Cost of the Work is a component of the Contract Price, under cost-plus-fee, time-and-materials, or other cost-based terms; or
 2. To determine the value of a Change Order, Change Proposal, Claim, set-off, or other adjustment in Contract Price. When the value of any such adjustment is determined on the basis of Cost of the Work, Contractor is entitled only to those additional or incremental costs required because of the change in the Work or because of the event giving rise to the adjustment.
- B. *Costs Included:* Except as otherwise may be agreed to in writing by Owner, costs included in the Cost of the Work shall be in amounts no higher than those prevailing in the locality of the Project, shall not include any of the costs itemized in Paragraph 13.01.C, and shall include only the following items:
1. Payroll costs for employees in the direct employ of Contractor in the performance of the Work under schedules of job classifications agreed upon by Owner and Contractor. Such employees shall include, without limitation, superintendents, foremen, and other personnel employed full time on the Work. Payroll costs for employees not employed full time on the Work shall be apportioned on the basis of their time spent on the Work. Payroll costs shall include, but not be limited to, salaries and wages plus the cost of fringe benefits, which shall include social security contributions, unemployment, excise, and payroll taxes, workers' compensation, health and retirement benefits, bonuses, sick leave, and vacation and holiday pay applicable thereto. The expenses of performing Work outside of regular working hours, on Saturday, Sunday, or legal holidays, shall be included in the above to the extent authorized by Owner.
 2. Cost of all materials and equipment furnished and incorporated in the Work, including costs of transportation and storage thereof, and Suppliers' field services required in connection therewith. All cash discounts shall accrue to Contractor unless Owner deposits funds with Contractor with which to make payments, in which case the cash discounts shall accrue to Owner. All trade discounts, rebates, and refunds and returns from sale of surplus materials and equipment shall accrue to Owner, and Contractor shall make provisions so that they may be obtained.
 3. Payments made by Contractor to Subcontractors for Work performed by Subcontractors. If required by Owner, Contractor shall obtain competitive bids from subcontractors acceptable to Owner and Contractor and shall deliver such bids to Owner, who will then determine, with the advice of Engineer, which bids, if any, will be acceptable. If any subcontract provides that the

Subcontractor is to be paid on the basis of Cost of the Work plus a fee, the Subcontractor's Cost of the Work and fee shall be determined in the same manner as Contractor's Cost of the Work and fee as provided in this Paragraph 13.01.

4. Costs of special consultants (including but not limited to engineers, architects, testing laboratories, surveyors, attorneys, and accountants) employed for services specifically related to the Work.
5. Supplemental costs including the following:
 - a. The proportion of necessary transportation, travel, and subsistence expenses of Contractor's employees incurred in discharge of duties connected with the Work.
 - b. Cost, including transportation and maintenance, of all materials, supplies, equipment, machinery, appliances, office, and temporary facilities at the Site, and hand tools not owned by the workers, which are consumed in the performance of the Work, and cost, less market value, of such items used but not consumed which remain the property of Contractor.
 - c. Rentals of all construction equipment and machinery, and the parts thereof, whether rented from Contractor or others in accordance with rental agreements approved by Owner with the advice of Engineer, and the costs of transportation, loading, unloading, assembly, dismantling, and removal thereof. All such costs shall be in accordance with the terms of said rental agreements. The rental of any such equipment, machinery, or parts shall cease when the use thereof is no longer necessary for the Work.
 - d. Sales, consumer, use, and other similar taxes related to the Work, and for which Contractor is liable, as imposed by Laws and Regulations.
 - e. Deposits lost for causes other than negligence of Contractor, any Subcontractor, or anyone directly or indirectly employed by any of them or for whose acts any of them may be liable, and royalty payments and fees for permits and licenses.
 - f. Losses and damages (and related expenses) caused by damage to the Work, not compensated by insurance or otherwise, sustained by Contractor in connection with the performance of the Work (except losses and damages within the deductible amounts of property insurance established in accordance with Paragraph 6.05), provided such losses and damages have resulted from causes other than the negligence of Contractor, any Subcontractor, or anyone directly or indirectly employed by any of them or for whose acts any of them may be liable. Such losses shall include settlements made with the written consent and approval of Owner. No such losses, damages, and expenses shall be included in the Cost of the Work for the purpose of determining Contractor's fee.
 - g. The cost of utilities, fuel, and sanitary facilities at the Site.

- h. Minor expenses such as communication service at the Site, express and courier services, and similar petty cash items in connection with the Work.
 - i. The costs of premiums for all bonds and insurance that Contractor is required by the Contract Documents to purchase and maintain.
- C. *Costs Excluded*: The term Cost of the Work shall not include any of the following items:
- 1. Payroll costs and other compensation of Contractor's officers, executives, principals (of partnerships and sole proprietorships), general managers, safety managers, engineers, architects, estimators, attorneys, auditors, accountants, purchasing and contracting agents, expeditors, timekeepers, clerks, and other personnel employed by Contractor, whether at the Site or in Contractor's principal or branch office for general administration of the Work and not specifically included in the agreed upon schedule of job classifications referred to in Paragraph 13.01.B.1 or specifically covered by Paragraph 13.01.B.4. The payroll costs and other compensation excluded here are to be considered administrative costs covered by the Contractor's fee.
 - 2. Expenses of Contractor's principal and branch offices other than Contractor's office at the Site.
 - 3. Any part of Contractor's capital expenses, including interest on Contractor's capital employed for the Work and charges against Contractor for delinquent payments.
 - 4. Costs due to the negligence of Contractor, any Subcontractor, or anyone directly or indirectly employed by any of them or for whose acts any of them may be liable, including but not limited to, the correction of defective Work, disposal of materials or equipment wrongly supplied, and making good any damage to property.
 - 5. Other overhead or general expense costs of any kind and the costs of any item not specifically and expressly included in Paragraph 13.01.B.
- D. *Contractor's Fee*: When the Work as a whole is performed on the basis of cost-plus, Contractor's fee shall be determined as set forth in the Agreement. When the value of any Work covered by a Change Order, Change Proposal, Claim, set-off, or other adjustment in Contract Price is determined on the basis of Cost of the Work, Contractor's fee shall be determined as set forth in Paragraph 11.04.C.
- E. *Documentation*: Whenever the Cost of the Work for any purpose is to be determined pursuant to this Article 13, Contractor will establish and maintain records thereof in accordance with generally accepted accounting practices and submit in a form acceptable to Engineer an itemized cost breakdown together with supporting data.

13.02 Allowances

- A. It is understood that Contractor has included in the Contract Price all allowances so named in the Contract Documents and shall cause the Work so covered to be performed for such sums and by such persons or entities as may be acceptable to Owner and Engineer.

- B. *Cash Allowances*: Contractor agrees that:
 - 1. the cash allowances include the cost to Contractor (less any applicable trade discounts) of materials and equipment required by the allowances to be delivered at the Site, and all applicable taxes; and
 - 2. Contractor's costs for unloading and handling on the Site, labor, installation, overhead, profit, and other expenses contemplated for the cash allowances have been included in the Contract Price and not in the allowances, and no demand for additional payment on account of any of the foregoing will be valid.
- C. *Contingency Allowance*: Contractor agrees that a contingency allowance, if any, is for the sole use of Owner to cover unanticipated costs.
- D. Prior to final payment, an appropriate Change Order will be issued as recommended by Engineer to reflect actual amounts due Contractor on account of Work covered by allowances, and the Contract Price shall be correspondingly adjusted.

13.03 *Unit Price Work*

- A. Where the Contract Documents provide that all or part of the Work is to be Unit Price Work, initially the Contract Price will be deemed to include for all Unit Price Work an amount equal to the sum of the unit price for each separately identified item of Unit Price Work times the estimated quantity of each item as indicated in the Agreement.
- B. The estimated quantities of items of Unit Price Work are not guaranteed and are solely for the purpose of comparison of Bids and determining an initial Contract Price. Payments to Contractor for Unit Price Work will be based on actual quantities.
- C. Each unit price will be deemed to include an amount considered by Contractor to be adequate to cover Contractor's overhead and profit for each separately identified item.
- D. Engineer will determine the actual quantities and classifications of Unit Price Work performed by Contractor. Engineer will review with Contractor the Engineer's preliminary determinations on such matters before rendering a written decision thereon (by recommendation of an Application for Payment or otherwise). Engineer's written decision thereon will be final and binding (except as modified by Engineer to reflect changed factual conditions or more accurate data) upon Owner and Contractor, subject to the provisions of the following paragraph.
- E. Within 30 days of Engineer's written decision under the preceding paragraph, Contractor may submit a Change Proposal, or Owner may file a Claim, seeking an adjustment in the Contract Price if:
 - 1. the quantity of any item of Unit Price Work performed by Contractor differs materially and significantly from the estimated quantity of such item indicated in the Agreement;
 - 2. there is no corresponding adjustment with respect to any other item of Work; and

3. Contractor believes that it is entitled to an increase in Contract Price as a result of having incurred additional expense or Owner believes that Owner is entitled to a decrease in Contract Price, and the parties are unable to agree as to the amount of any such increase or decrease.

ARTICLE 14 – TESTS AND INSPECTIONS; CORRECTION, REMOVAL OR ACCEPTANCE OF DEFECTIVE WORK

14.01 Access to Work

- A. Owner, Engineer, their consultants and other representatives and personnel of Owner, independent testing laboratories, and authorities having jurisdiction will have access to the Site and the Work at reasonable times for their observation, inspection, and testing. Contractor shall provide them proper and safe conditions for such access and advise them of Contractor's safety procedures and programs so that they may comply therewith as applicable.

14.02 Tests, Inspections, and Approvals

- A. Contractor shall give Engineer timely notice of readiness of the Work (or specific parts thereof) for all required inspections and tests, and shall cooperate with inspection and testing personnel to facilitate required inspections and tests.
- B. Owner shall retain and pay for the services of an independent inspector, testing laboratory, or other qualified individual or entity to perform all inspections and tests expressly required by the Contract Documents to be furnished and paid for by Owner, except that costs incurred in connection with tests or inspections of covered Work shall be governed by the provisions of Paragraph 14.05.
- C. If Laws or Regulations of any public body having jurisdiction require any Work (or part thereof) specifically to be inspected, tested, or approved by an employee or other representative of such public body, Contractor shall assume full responsibility for arranging and obtaining such inspections, tests, or approvals, pay all costs in connection therewith, and furnish Engineer the required certificates of inspection or approval.
- D. Contractor shall be responsible for arranging, obtaining, and paying for all inspections and tests required:
 1. by the Contract Documents, unless the Contract Documents expressly allocate responsibility for a specific inspection or test to Owner;
 2. to attain Owner's and Engineer's acceptance of materials or equipment to be incorporated in the Work;
 3. by manufacturers of equipment furnished under the Contract Documents;
 4. for testing, adjusting, and balancing of mechanical, electrical, and other equipment to be incorporated into the Work; and
 5. for acceptance of materials, mix designs, or equipment submitted for approval prior to Contractor's purchase thereof for incorporation in the Work.

Such inspections and tests shall be performed by independent inspectors, testing laboratories, or other qualified individuals or entities acceptable to Owner and Engineer.

- E. If the Contract Documents require the Work (or part thereof) to be approved by Owner, Engineer, or another designated individual or entity, then Contractor shall assume full responsibility for arranging and obtaining such approvals.
- F. If any Work (or the work of others) that is to be inspected, tested, or approved is covered by Contractor without written concurrence of Engineer, Contractor shall, if requested by Engineer, uncover such Work for observation. Such uncovering shall be at Contractor's expense unless Contractor had given Engineer timely notice of Contractor's intention to cover the same and Engineer had not acted with reasonable promptness in response to such notice.

14.03 *Defective Work*

- A. *Contractor's Obligation:* It is Contractor's obligation to assure that the Work is not defective.
- B. *Engineer's Authority:* Engineer has the authority to determine whether Work is defective, and to reject defective Work.
- C. *Notice of Defects:* Prompt notice of all defective Work of which Owner or Engineer has actual knowledge will be given to Contractor.
- D. *Correction, or Removal and Replacement:* Promptly after receipt of written notice of defective Work, Contractor shall correct all such defective Work, whether or not fabricated, installed, or completed, or, if Engineer has rejected the defective Work, remove it from the Project and replace it with Work that is not defective.
- E. *Preservation of Warranties:* When correcting defective Work, Contractor shall take no action that would void or otherwise impair Owner's special warranty and guarantee, if any, on said Work.
- F. *Costs and Damages:* In addition to its correction, removal, and replacement obligations with respect to defective Work, Contractor shall pay all claims, costs, losses, and damages arising out of or relating to defective Work, including but not limited to the cost of the inspection, testing, correction, removal, replacement, or reconstruction of such defective Work, fines levied against Owner by governmental authorities because the Work is defective, and the costs of repair or replacement of work of others resulting from defective Work. Prior to final payment, if Owner and Contractor are unable to agree as to the measure of such claims, costs, losses, and damages resulting from defective Work, then Owner may impose a reasonable set-off against payments due under Article 15.

14.04 *Acceptance of Defective Work*

- A. If, instead of requiring correction or removal and replacement of defective Work, Owner prefers to accept it, Owner may do so (subject, if such acceptance occurs prior to final payment, to Engineer's confirmation that such acceptance is in general accord with the design intent and applicable engineering principles, and will not endanger public safety). Contractor shall pay all claims, costs, losses, and damages

attributable to Owner's evaluation of and determination to accept such defective Work (such costs to be approved by Engineer as to reasonableness), and for the diminished value of the Work to the extent not otherwise paid by Contractor. If any such acceptance occurs prior to final payment, the necessary revisions in the Contract Documents with respect to the Work shall be incorporated in a Change Order. If the parties are unable to agree as to the decrease in the Contract Price, reflecting the diminished value of Work so accepted, then Owner may impose a reasonable set-off against payments due under Article 15. If the acceptance of defective Work occurs after final payment, Contractor shall pay an appropriate amount to Owner.

14.05 *Uncovering Work*

- A. Engineer has the authority to require additional inspection or testing of the Work, whether or not the Work is fabricated, installed, or completed.
- B. If any Work is covered contrary to the written request of Engineer, then Contractor shall, if requested by Engineer, uncover such Work for Engineer's observation, and then replace the covering, all at Contractor's expense.
- C. If Engineer considers it necessary or advisable that covered Work be observed by Engineer or inspected or tested by others, then Contractor, at Engineer's request, shall uncover, expose, or otherwise make available for observation, inspection, or testing as Engineer may require, that portion of the Work in question, and provide all necessary labor, material, and equipment.
 - 1. If it is found that the uncovered Work is defective, Contractor shall be responsible for all claims, costs, losses, and damages arising out of or relating to such uncovering, exposure, observation, inspection, and testing, and of satisfactory replacement or reconstruction (including but not limited to all costs of repair or replacement of work of others); and pending Contractor's full discharge of this responsibility the Owner shall be entitled to impose a reasonable set-off against payments due under Article 15.
 - 2. If the uncovered Work is not found to be defective, Contractor shall be allowed an increase in the Contract Price or an extension of the Contract Times, or both, directly attributable to such uncovering, exposure, observation, inspection, testing, replacement, and reconstruction. If the parties are unable to agree as to the amount or extent thereof, then Contractor may submit a Change Proposal within 30 days of the determination that the Work is not defective.

14.06 *Owner May Stop the Work*

- A. If the Work is defective, or Contractor fails to supply sufficient skilled workers or suitable materials or equipment, or fails to perform the Work in such a way that the completed Work will conform to the Contract Documents, then Owner may order Contractor to stop the Work, or any portion thereof, until the cause for such order has been eliminated; however, this right of Owner to stop the Work shall not give rise to any duty on the part of Owner to exercise this right for the benefit of Contractor, any Subcontractor, any Supplier, any other individual or entity, or any surety for, or employee or agent of any of them.

14.07 *Owner May Correct Defective Work*

- A. If Contractor fails within a reasonable time after written notice from Engineer to correct defective Work, or to remove and replace rejected Work as required by Engineer, or if Contractor fails to perform the Work in accordance with the Contract Documents, or if Contractor fails to comply with any other provision of the Contract Documents, then Owner may, after seven days written notice to Contractor, correct or remedy any such deficiency.
- B. In exercising the rights and remedies under this Paragraph 14.07, Owner shall proceed expeditiously. In connection with such corrective or remedial action, Owner may exclude Contractor from all or part of the Site, take possession of all or part of the Work and suspend Contractor's services related thereto, and incorporate in the Work all materials and equipment stored at the Site or for which Owner has paid Contractor but which are stored elsewhere. Contractor shall allow Owner, Owner's representatives, agents and employees, Owner's other contractors, and Engineer and Engineer's consultants access to the Site to enable Owner to exercise the rights and remedies under this paragraph.
- C. All claims, costs, losses, and damages incurred or sustained by Owner in exercising the rights and remedies under this Paragraph 14.07 will be charged against Contractor as set-offs against payments due under Article 15. Such claims, costs, losses and damages will include but not be limited to all costs of repair, or replacement of work of others destroyed or damaged by correction, removal, or replacement of Contractor's defective Work.
- D. Contractor shall not be allowed an extension of the Contract Times because of any delay in the performance of the Work attributable to the exercise by Owner of Owner's rights and remedies under this Paragraph 14.07.

ARTICLE 15 – PAYMENTS TO CONTRACTOR; SET-OFFS; COMPLETION; CORRECTION PERIOD

15.01 *Progress Payments*

- A. *Basis for Progress Payments:* The Schedule of Values established as provided in Article 2 will serve as the basis for progress payments and will be incorporated into a form of Application for Payment acceptable to Engineer. Progress payments on account of Unit Price Work will be based on the number of units completed during the pay period, as determined under the provisions of Paragraph 13.03. Progress payments for cost-based Work will be based on Cost of the Work completed by Contractor during the pay period.
- B. *Applications for Payments:*
 - 1. At least 20 days before the date established in the Agreement for each progress payment (but not more often than once a month), Contractor shall submit to Engineer for review an Application for Payment filled out and signed by Contractor covering the Work completed as of the date of the Application and accompanied by such supporting documentation as is required by the Contract Documents. If payment is requested on the basis of materials and equipment not

incorporated in the Work but delivered and suitably stored at the Site or at another location agreed to in writing, the Application for Payment shall also be accompanied by a bill of sale, invoice, or other documentation warranting that Owner has received the materials and equipment free and clear of all Liens, and evidence that the materials and equipment are covered by appropriate property insurance, a warehouse bond, or other arrangements to protect Owner's interest therein, all of which must be satisfactory to Owner.

2. Beginning with the second Application for Payment, each Application shall include an affidavit of Contractor stating that all previous progress payments received on account of the Work have been applied on account to discharge Contractor's legitimate obligations associated with prior Applications for Payment.
3. The amount of retainage with respect to progress payments will be as stipulated in the Agreement.

C. Review of Applications:

1. Engineer will, within 10 days after receipt of each Application for Payment, including each resubmittal, either indicate in writing a recommendation of payment and present the Application to Owner, or return the Application to Contractor indicating in writing Engineer's reasons for refusing to recommend payment. In the latter case, Contractor may make the necessary corrections and resubmit the Application.
2. Engineer's recommendation of any payment requested in an Application for Payment will constitute a representation by Engineer to Owner, based on Engineer's observations of the executed Work as an experienced and qualified design professional, and on Engineer's review of the Application for Payment and the accompanying data and schedules, that to the best of Engineer's knowledge, information and belief:
 - a. the Work has progressed to the point indicated;
 - b. the quality of the Work is generally in accordance with the Contract Documents (subject to an evaluation of the Work as a functioning whole prior to or upon Substantial Completion, the results of any subsequent tests called for in the Contract Documents, a final determination of quantities and classifications for Unit Price Work under Paragraph 13.03, and any other qualifications stated in the recommendation); and
 - c. the conditions precedent to Contractor's being entitled to such payment appear to have been fulfilled in so far as it is Engineer's responsibility to observe the Work.
3. By recommending any such payment Engineer will not thereby be deemed to have represented that:
 - a. inspections made to check the quality or the quantity of the Work as it has been performed have been exhaustive, extended to every aspect of the Work

- in progress, or involved detailed inspections of the Work beyond the responsibilities specifically assigned to Engineer in the Contract; or
- b. there may not be other matters or issues between the parties that might entitle Contractor to be paid additionally by Owner or entitle Owner to withhold payment to Contractor.
4. Neither Engineer's review of Contractor's Work for the purposes of recommending payments nor Engineer's recommendation of any payment, including final payment, will impose responsibility on Engineer:
 - a. to supervise, direct, or control the Work, or
 - b. for the means, methods, techniques, sequences, or procedures of construction, or the safety precautions and programs incident thereto, or
 - c. for Contractor's failure to comply with Laws and Regulations applicable to Contractor's performance of the Work, or
 - d. to make any examination to ascertain how or for what purposes Contractor has used the money paid on account of the Contract Price, or
 - e. to determine that title to any of the Work, materials, or equipment has passed to Owner free and clear of any Liens.
 5. Engineer may refuse to recommend the whole or any part of any payment if, in Engineer's opinion, it would be incorrect to make the representations to Owner stated in Paragraph 15.01.C.2.
 6. Engineer will recommend reductions in payment (set-offs) necessary in Engineer's opinion to protect Owner from loss because:
 - a. the Work is defective, requiring correction or replacement;
 - b. the Contract Price has been reduced by Change Orders;
 - c. Owner has been required to correct defective Work in accordance with Paragraph 14.07, or has accepted defective Work pursuant to Paragraph 14.04;
 - d. Owner has been required to remove or remediate a Hazardous Environmental Condition for which Contractor is responsible; or
 - e. Engineer has actual knowledge of the occurrence of any of the events that would constitute a default by Contractor and therefore justify termination for cause under the Contract Documents.

D. Payment Becomes Due:

1. Ten days after presentation of the Application for Payment to Owner with Engineer's recommendation, the amount recommended (subject to any Owner set-offs) will become due, and when due will be paid by Owner to Contractor.

E. *Reductions in Payment by Owner:*

1. In addition to any reductions in payment (set-offs) recommended by Engineer, Owner is entitled to impose a set-off against payment based on any of the following:
 - a. claims have been made against Owner on account of Contractor's conduct in the performance or furnishing of the Work, or Owner has incurred costs, losses, or damages on account of Contractor's conduct in the performance or furnishing of the Work, including but not limited to claims, costs, losses, or damages from workplace injuries, adjacent property damage, non-compliance with Laws and Regulations, and patent infringement;
 - b. Contractor has failed to take reasonable and customary measures to avoid damage, delay, disruption, and interference with other work at or adjacent to the Site;
 - c. Contractor has failed to provide and maintain required bonds or insurance;
 - d. Owner has been required to remove or remediate a Hazardous Environmental Condition for which Contractor is responsible;
 - e. Owner has incurred extra charges or engineering costs related to submittal reviews, evaluations of proposed substitutes, tests and inspections, or return visits to manufacturing or assembly facilities;
 - f. the Work is defective, requiring correction or replacement;
 - g. Owner has been required to correct defective Work in accordance with Paragraph 14.07, or has accepted defective Work pursuant to Paragraph 14.04;
 - h. the Contract Price has been reduced by Change Orders;
 - i. an event that would constitute a default by Contractor and therefore justify a termination for cause has occurred;
 - j. liquidated damages have accrued as a result of Contractor's failure to achieve Milestones, Substantial Completion, or final completion of the Work;
 - k. Liens have been filed in connection with the Work, except where Contractor has delivered a specific bond satisfactory to Owner to secure the satisfaction and discharge of such Liens;
 - l. there are other items entitling Owner to a set off against the amount recommended.
2. If Owner imposes any set-off against payment, whether based on its own knowledge or on the written recommendations of Engineer, Owner will give Contractor immediate written notice (with a copy to Engineer) stating the reasons for such action and the specific amount of the reduction, and promptly pay Contractor any amount remaining after deduction of the amount so withheld. Owner shall promptly pay Contractor the amount so withheld, or any

adjustment thereto agreed to by Owner and Contractor, if Contractor remedies the reasons for such action. The reduction imposed shall be binding on Contractor unless it duly submits a Change Proposal contesting the reduction.

3. Upon a subsequent determination that Owner's refusal of payment was not justified, the amount wrongfully withheld shall be treated as an amount due as determined by Paragraph 15.01.C.1 and subject to interest as provided in the Agreement.

15.02 *Contractor's Warranty of Title*

- A. Contractor warrants and guarantees that title to all Work, materials, and equipment furnished under the Contract will pass to Owner free and clear of (1) all Liens and other title defects, and (2) all patent, licensing, copyright, or royalty obligations, no later than seven days after the time of payment by Owner.

15.03 *Substantial Completion*

- A. When Contractor considers the entire Work ready for its intended use Contractor shall notify Owner and Engineer in writing that the entire Work is substantially complete and request that Engineer issue a certificate of Substantial Completion. Contractor shall at the same time submit to Owner and Engineer an initial draft of punch list items to be completed or corrected before final payment.
- B. Promptly after Contractor's notification, Owner, Contractor, and Engineer shall make an inspection of the Work to determine the status of completion. If Engineer does not consider the Work substantially complete, Engineer will notify Contractor in writing giving the reasons therefor.
- C. If Engineer considers the Work substantially complete, Engineer will deliver to Owner a preliminary certificate of Substantial Completion which shall fix the date of Substantial Completion. Engineer shall attach to the certificate a punch list of items to be completed or corrected before final payment. Owner shall have seven days after receipt of the preliminary certificate during which to make written objection to Engineer as to any provisions of the certificate or attached punch list. If, after considering the objections to the provisions of the preliminary certificate, Engineer concludes that the Work is not substantially complete, Engineer will, within 14 days after submission of the preliminary certificate to Owner, notify Contractor in writing that the Work is not substantially complete, stating the reasons therefor. If Owner does not object to the provisions of the certificate, or if despite consideration of Owner's objections Engineer concludes that the Work is substantially complete, then Engineer will, within said 14 days, execute and deliver to Owner and Contractor a final certificate of Substantial Completion (with a revised punch list of items to be completed or corrected) reflecting such changes from the preliminary certificate as Engineer believes justified after consideration of any objections from Owner.
- D. At the time of receipt of the preliminary certificate of Substantial Completion, Owner and Contractor will confer regarding Owner's use or occupancy of the Work following Substantial Completion, review the builder's risk insurance policy with respect to the end of the builder's risk coverage, and confirm the transition to coverage of the Work under a permanent property insurance policy held by Owner.

Unless Owner and Contractor agree otherwise in writing, Owner shall bear responsibility for security, operation, protection of the Work, property insurance, maintenance, heat, and utilities upon Owner's use or occupancy of the Work.

- E. After Substantial Completion the Contractor shall promptly begin work on the punch list of items to be completed or corrected prior to final payment. In appropriate cases Contractor may submit monthly Applications for Payment for completed punch list items, following the progress payment procedures set forth above.
- F. Owner shall have the right to exclude Contractor from the Site after the date of Substantial Completion subject to allowing Contractor reasonable access to remove its property and complete or correct items on the punch list.

15.04 *Partial Use or Occupancy*

- A. Prior to Substantial Completion of all the Work, Owner may use or occupy any substantially completed part of the Work which has specifically been identified in the Contract Documents, or which Owner, Engineer, and Contractor agree constitutes a separately functioning and usable part of the Work that can be used by Owner for its intended purpose without significant interference with Contractor's performance of the remainder of the Work, subject to the following conditions:
 - 1. At any time Owner may request in writing that Contractor permit Owner to use or occupy any such part of the Work that Owner believes to be substantially complete. If and when Contractor agrees that such part of the Work is substantially complete, Contractor, Owner, and Engineer will follow the procedures of Paragraph 15.03.A through E for that part of the Work.
 - 2. At any time Contractor may notify Owner and Engineer in writing that Contractor considers any such part of the Work substantially complete and request Engineer to issue a certificate of Substantial Completion for that part of the Work.
 - 3. Within a reasonable time after either such request, Owner, Contractor, and Engineer shall make an inspection of that part of the Work to determine its status of completion. If Engineer does not consider that part of the Work to be substantially complete, Engineer will notify Owner and Contractor in writing giving the reasons therefor. If Engineer considers that part of the Work to be substantially complete, the provisions of Paragraph 15.03 will apply with respect to certification of Substantial Completion of that part of the Work and the division of responsibility in respect thereof and access thereto.
 - 4. No use or occupancy or separate operation of part of the Work may occur prior to compliance with the requirements of Paragraph 6.05 regarding builder's risk or other property insurance.

15.05 *Final Inspection*

- A. Upon written notice from Contractor that the entire Work or an agreed portion thereof is complete, Engineer will promptly make a final inspection with Owner and Contractor and will notify Contractor in writing of all particulars in which this inspection reveals that the Work, or agreed portion thereof, is incomplete or

defective. Contractor shall immediately take such measures as are necessary to complete such Work or remedy such deficiencies.

15.06 *Final Payment*

A. *Application for Payment:*

1. After Contractor has, in the opinion of Engineer, satisfactorily completed all corrections identified during the final inspection and has delivered, in accordance with the Contract Documents, all maintenance and operating instructions, schedules, guarantees, bonds, certificates or other evidence of insurance, certificates of inspection, annotated record documents (as provided in Paragraph 7.11), and other documents, Contractor may make application for final payment.
2. The final Application for Payment shall be accompanied (except as previously delivered) by:
 - a. all documentation called for in the Contract Documents;
 - b. consent of the surety, if any, to final payment;
 - c. satisfactory evidence that all title issues have been resolved such that title to all Work, materials, and equipment has passed to Owner free and clear of any Liens or other title defects, or will so pass upon final payment.
 - d. a list of all disputes that Contractor believes are unsettled; and
 - e. complete and legally effective releases or waivers (satisfactory to Owner) of all Lien rights arising out of the Work, and of Liens filed in connection with the Work.
3. In lieu of the releases or waivers of Liens specified in Paragraph 15.06.A.2 and as approved by Owner, Contractor may furnish receipts or releases in full and an affidavit of Contractor that: (a) the releases and receipts include all labor, services, material, and equipment for which a Lien could be filed; and (b) all payrolls, material and equipment bills, and other indebtedness connected with the Work for which Owner might in any way be responsible, or which might in any way result in liens or other burdens on Owner's property, have been paid or otherwise satisfied. If any Subcontractor or Supplier fails to furnish such a release or receipt in full, Contractor may furnish a bond or other collateral satisfactory to Owner to indemnify Owner against any Lien, or Owner at its option may issue joint checks payable to Contractor and specified Subcontractors and Suppliers.

B. *Engineer's Review of Application and Acceptance:*

1. If, on the basis of Engineer's observation of the Work during construction and final inspection, and Engineer's review of the final Application for Payment and accompanying documentation as required by the Contract Documents, Engineer is satisfied that the Work has been completed and Contractor's other obligations under the Contract have been fulfilled, Engineer will, within ten days after receipt of the final Application for Payment, indicate in writing Engineer's

recommendation of final payment and present the Application for Payment to Owner for payment. Such recommendation shall account for any set-offs against payment that are necessary in Engineer's opinion to protect Owner from loss for the reasons stated above with respect to progress payments. At the same time Engineer will also give written notice to Owner and Contractor that the Work is acceptable, subject to the provisions of Paragraph 15.07. Otherwise, Engineer will return the Application for Payment to Contractor, indicating in writing the reasons for refusing to recommend final payment, in which case Contractor shall make the necessary corrections and resubmit the Application for Payment.

- C. *Completion of Work*: The Work is complete (subject to surviving obligations) when it is ready for final payment as established by the Engineer's written recommendation of final payment.
- D. *Payment Becomes Due*: Thirty days after the presentation to Owner of the final Application for Payment and accompanying documentation, the amount recommended by Engineer (less any further sum Owner is entitled to set off against Engineer's recommendation, including but not limited to set-offs for liquidated damages and set-offs allowed under the provisions above with respect to progress payments) will become due and shall be paid by Owner to Contractor.

15.07 *Waiver of Claims*

- A. The making of final payment will not constitute a waiver by Owner of claims or rights against Contractor. Owner expressly reserves claims and rights arising from unsettled Liens, from defective Work appearing after final inspection pursuant to Paragraph 15.05, from Contractor's failure to comply with the Contract Documents or the terms of any special guarantees specified therein, from outstanding Claims by Owner, or from Contractor's continuing obligations under the Contract Documents.
- B. The acceptance of final payment by Contractor will constitute a waiver by Contractor of all claims and rights against Owner other than those pending matters that have been duly submitted or appealed under the provisions of Article 17.

15.08 *Correction Period*

- A. If within one year after the date of Substantial Completion (or such longer period of time as may be prescribed by the terms of any applicable special guarantee required by the Contract Documents, or by any specific provision of the Contract Documents), any Work is found to be defective, or if the repair of any damages to the Site, adjacent areas that Contractor has arranged to use through construction easements or otherwise, and other adjacent areas used by Contractor as permitted by Laws and Regulations, is found to be defective, then Contractor shall promptly, without cost to Owner and in accordance with Owner's written instructions:
 - 1. correct the defective repairs to the Site or such other adjacent areas;
 - 2. correct such defective Work;
 - 3. if the defective Work has been rejected by Owner, remove it from the Project and replace it with Work that is not defective, and

4. satisfactorily correct or repair or remove and replace any damage to other Work, to the work of others, or to other land or areas resulting therefrom.
- B. If Contractor does not promptly comply with the terms of Owner's written instructions, or in an emergency where delay would cause serious risk of loss or damage, Owner may have the defective Work corrected or repaired or may have the rejected Work removed and replaced. Contractor shall pay all claims, costs, losses, and damages (including but not limited to all fees and charges of engineers, architects, attorneys, and other professionals and all court or arbitration or other dispute resolution costs) arising out of or relating to such correction or repair or such removal and replacement (including but not limited to all costs of repair or replacement of work of others).
 - C. In special circumstances where a particular item of equipment is placed in continuous service before Substantial Completion of all the Work, the correction period for that item may start to run from an earlier date if so provided in the Specifications.
 - D. Where defective Work (and damage to other Work resulting therefrom) has been corrected or removed and replaced under this paragraph, the correction period hereunder with respect to such Work will be extended for an additional period of one year after such correction or removal and replacement has been satisfactorily completed.
 - E. Contractor's obligations under this paragraph are in addition to all other obligations and warranties. The provisions of this paragraph shall not be construed as a substitute for, or a waiver of, the provisions of any applicable statute of limitation or repose.

ARTICLE 16 – SUSPENSION OF WORK AND TERMINATION

16.01 Owner May Suspend Work

- A. At any time and without cause, Owner may suspend the Work or any portion thereof for a period of not more than 90 consecutive days by written notice to Contractor and Engineer. Such notice will fix the date on which Work will be resumed. Contractor shall resume the Work on the date so fixed. Contractor shall be entitled to an adjustment in the Contract Price or an extension of the Contract Times, or both, directly attributable to any such suspension. Any Change Proposal seeking such adjustments shall be submitted no later than 30 days after the date fixed for resumption of Work.

16.02 Owner May Terminate for Cause

- A. The occurrence of any one or more of the following events will constitute a default by Contractor and justify termination for cause:
 1. Contractor's persistent failure to perform the Work in accordance with the Contract Documents (including, but not limited to, failure to supply sufficient

- skilled workers or suitable materials or equipment or failure to adhere to the Progress Schedule);
2. Failure of Contractor to perform or otherwise to comply with a material term of the Contract Documents;
 3. Contractor's disregard of Laws or Regulations of any public body having jurisdiction; or
 4. Contractor's repeated disregard of the authority of Owner or Engineer.
- B. If one or more of the events identified in Paragraph 16.02.A occurs, then after giving Contractor (and any surety) ten days written notice that Owner is considering a declaration that Contractor is in default and termination of the contract, Owner may proceed to:
1. declare Contractor to be in default, and give Contractor (and any surety) notice that the Contract is terminated; and
 2. enforce the rights available to Owner under any applicable performance bond.
- C. Subject to the terms and operation of any applicable performance bond, if Owner has terminated the Contract for cause, Owner may exclude Contractor from the Site, take possession of the Work, incorporate in the Work all materials and equipment stored at the Site or for which Owner has paid Contractor but which are stored elsewhere, and complete the Work as Owner may deem expedient.
- D. Owner may not proceed with termination of the Contract under Paragraph 16.02.B if Contractor within seven days of receipt of notice of intent to terminate begins to correct its failure to perform and proceeds diligently to cure such failure.
- E. If Owner proceeds as provided in Paragraph 16.02.B, Contractor shall not be entitled to receive any further payment until the Work is completed. If the unpaid balance of the Contract Price exceeds the cost to complete the Work, including all related claims, costs, losses, and damages (including but not limited to all fees and charges of engineers, architects, attorneys, and other professionals) sustained by Owner, such excess will be paid to Contractor. If the cost to complete the Work including such related claims, costs, losses, and damages exceeds such unpaid balance, Contractor shall pay the difference to Owner. Such claims, costs, losses, and damages incurred by Owner will be reviewed by Engineer as to their reasonableness and, when so approved by Engineer, incorporated in a Change Order. When exercising any rights or remedies under this paragraph, Owner shall not be required to obtain the lowest price for the Work performed.
- F. Where Contractor's services have been so terminated by Owner, the termination will not affect any rights or remedies of Owner against Contractor then existing or which may thereafter accrue, or any rights or remedies of Owner against Contractor or any surety under any payment bond or performance bond. Any retention or payment of money due Contractor by Owner will not release Contractor from liability.
- G. If and to the extent that Contractor has provided a performance bond under the provisions of Paragraph 6.01.A, the provisions of that bond shall govern over any inconsistent provisions of Paragraphs 16.02.B and 16.02.D.

16.03 *Owner May Terminate For Convenience*

- A. Upon seven days written notice to Contractor and Engineer, Owner may, without cause and without prejudice to any other right or remedy of Owner, terminate the Contract. In such case, Contractor shall be paid for (without duplication of any items):
 - 1. completed and acceptable Work executed in accordance with the Contract Documents prior to the effective date of termination, including fair and reasonable sums for overhead and profit on such Work;
 - 2. expenses sustained prior to the effective date of termination in performing services and furnishing labor, materials, or equipment as required by the Contract Documents in connection with uncompleted Work, plus fair and reasonable sums for overhead and profit on such expenses; and
 - 3. other reasonable expenses directly attributable to termination, including costs incurred to prepare a termination for convenience cost proposal.
- B. Contractor shall not be paid on account of loss of anticipated overhead, profits, or revenue, or other economic loss arising out of or resulting from such termination.

16.04 *Contractor May Stop Work or Terminate*

- A. If, through no act or fault of Contractor, (1) the Work is suspended for more than 90 consecutive days by Owner or under an order of court or other public authority, or (2) Engineer fails to act on any Application for Payment within 30 days after it is submitted, or (3) Owner fails for 30 days to pay Contractor any sum finally determined to be due, then Contractor may, upon seven days written notice to Owner and Engineer, and provided Owner or Engineer do not remedy such suspension or failure within that time, terminate the contract and recover from Owner payment on the same terms as provided in Paragraph 16.03.
- B. In lieu of terminating the Contract and without prejudice to any other right or remedy, if Engineer has failed to act on an Application for Payment within 30 days after it is submitted, or Owner has failed for 30 days to pay Contractor any sum finally determined to be due, Contractor may, seven days after written notice to Owner and Engineer, stop the Work until payment is made of all such amounts due Contractor, including interest thereon. The provisions of this paragraph are not intended to preclude Contractor from submitting a Change Proposal for an adjustment in Contract Price or Contract Times or otherwise for expenses or damage directly attributable to Contractor's stopping the Work as permitted by this paragraph.

ARTICLE 17 – FINAL RESOLUTION OF DISPUTES

17.01 Methods and Procedures

- A. *Disputes Subject to Final Resolution:* The following disputed matters are subject to final resolution under the provisions of this Article:
1. A timely appeal of an approval in part and denial in part of a Claim, or of a denial in full; and
 2. Disputes between Owner and Contractor concerning the Work or obligations under the Contract Documents, and arising after final payment has been made.
- B. *Final Resolution of Disputes:* For any dispute subject to resolution under this Article, Owner or Contractor may:
1. elect in writing to invoke the dispute resolution process provided for in the Supplementary Conditions; or
 2. agree with the other party to submit the dispute to another dispute resolution process; or
 3. if no dispute resolution process is provided for in the Supplementary Conditions or mutually agreed to, give written notice to the other party of the intent to submit the dispute to a court of competent jurisdiction.

ARTICLE 18 – MISCELLANEOUS

18.01 Giving Notice

- A. Whenever any provision of the Contract Documents requires the giving of written notice, it will be deemed to have been validly given if:
1. delivered in person, by a commercial courier service or otherwise, to the individual or to a member of the firm or to an officer of the corporation for which it is intended; or
 2. delivered at or sent by registered or certified mail, postage prepaid, to the last business address known to the sender of the notice.

18.02 Computation of Times

- A. When any period of time is referred to in the Contract by days, it will be computed to exclude the first and include the last day of such period. If the last day of any such period falls on a Saturday or Sunday or on a day made a legal holiday by the law of the applicable jurisdiction, such day will be omitted from the computation.

18.03 Cumulative Remedies

- A. The duties and obligations imposed by these General Conditions and the rights and remedies available hereunder to the parties hereto are in addition to, and are not to be construed in any way as a limitation of, any rights and remedies available to any or all of them which are otherwise imposed or available by Laws or Regulations, by special warranty or guarantee, or by other provisions of the Contract. The provisions of this paragraph will be as effective as if repeated specifically in the Contract

Documents in connection with each particular duty, obligation, right, and remedy to which they apply.

18.04 *Limitation of Damages*

- A. With respect to any and all Change Proposals, Claims, disputes subject to final resolution, and other matters at issue, neither Owner nor Engineer, nor any of their officers, directors, members, partners, employees, agents, consultants, or subcontractors, shall be liable to Contractor for any claims, costs, losses, or damages sustained by Contractor on or in connection with any other project or anticipated project.

18.05 *No Waiver*

- A. A party's non-enforcement of any provision shall not constitute a waiver of that provision, nor shall it affect the enforceability of that provision or of the remainder of this Contract.

18.06 *Survival of Obligations*

- A. All representations, indemnifications, warranties, and guarantees made in, required by, or given in accordance with the Contract, as well as all continuing obligations indicated in the Contract, will survive final payment, completion, and acceptance of the Work or termination or completion of the Contract or termination of the services of Contractor.

18.07 *Controlling Law*

- A. This Contract is to be governed by the law of the state in which the Project is located.

18.08 *Headings*

- A. Article and paragraph headings are inserted for convenience only and do not constitute parts of these General Conditions.

SECTION 00800

SUPPLEMENTAL GENERAL CONDITIONS

ARTICLE 1. DEFINITIONS AND TERMINOLOGY

SC-1.01.A.13

Add the following language at the beginning of the definition entitled "Contract Documents" in the General Conditions:

The Invitation to Bid, Instructions to Bidders

SC-1.01.A.28

Add the following language to the definition entitled "Owner" in the General Conditions:

The "Owner" shall mean the Town of Dedham, Massachusetts.

SC-1.01.A.40

Delete the definition of Substantial Completion in the General Conditions in its entirety and add the following in its place:

1. The Work required by the Contract has been completed except for work having a Contract Price of less than one percent of the then adjusted total contract price, or substantially all of the Work has been completed and opened to Owner's use except for minor incomplete or unsatisfactory work items that do not materially impair the usefulness of the Work required by the Contract.

SC-1.01.A.49

Add the following definition to the General Conditions:

"State" shall mean the Commonwealth of Massachusetts.

ARTICLE 2. PRELIMINARY MATTERS

SC-2.01.C

Delete this paragraph

SC-2.01.D

Add a new paragraph immediately after paragraph 2.01.C of the General Conditions, which is to read as follows:

- D. Non-Resident Contractor: The CONTRACTOR, if a corporation established under laws other than the State in which the proposed construction is located, shall file with the OWNER, notice of the name of its resident attorney-in-fact, appointed as required by the laws of the State in which the proposed construction is located. The CONTRACTOR, if a resident of a State other than that in which the proposed construction is located and not a corporation, shall file, at the time of execution of the Agreement, with the OWNER a written appointment of a resident of the State in which the construction is located, having an office or place of business therein, to be his true and lawful attorney upon whom all lawful processes in any actions or proceedings against him may be served; and in such writing, which shall set forth said attorney's place of residence, shall agree that any lawful process against him which is served on said attorney shall be of the same legal force and validity as if served on him and that the authority shall continue in force so long as any liability remains outstanding against him in said State. The power of attorney shall be filed in the office of the Secretary of the State if required, and copies certified by the Secretary shall be sufficient evidence thereof. Such appointment shall continue in force until revoked by an instrument in writing, designating in a like manner some other person upon whom such processes may be served, which instrument shall be filed in the manner provided herein for the original appointment.

SC-2.05

Add the following paragraphs immediately after paragraph 2.05.A.3 of the General Conditions which is to read as follows:

2.05.A.4 Before any work at the site is started, CONTRACTOR shall deliver to OWNER, with a copy to ENGINEER, certificates of insurance (and other evidence of insurance requested by OWNER) which CONTRACTOR is required to purchase and maintain in accordance with the requirements of Article 6.

2.05.A.5 Contractor shall include and identify on the certificate of insurance, indemnification as required by Article 7.18.

ARTICLE 3. DOCUMENTS: INTENT, REQUIREMENTS, REUSE

SC-3.01

Add the following paragraphs immediately after paragraph 3.01.A of the General Conditions which is to read as follows:

3.01.A.1 Each and every provision of law and clause required by law to be inserted in the Contract shall be deemed to be inserted herein, and the Contract shall be read and enforced as though they were included herein. If through mistake or otherwise any such provision is not inserted, or is not correctly inserted, then upon the application of either party, the Contract shall forthwith be physically amended to make such insertion.

3.01.A.2 Sections of Division 1 - General Requirements govern the execution of the work of all sections of the specifications.

SC-3.02.A.1

Delete the portion of the paragraph starting at “shall mean” through the end of this sentence and insert the following:

“shall mean the standard, specification, manual, code, or Laws or Regulations in effect and applicable at the time in question, except as may be otherwise specifically stated in the Contract Documents.”

SC-3.03.A.3

Delete Paragraph 3.03.A.3 in its entirety and insert the following:

“CONTRACTOR shall be liable to OWNER and/or ENGINEER for failure to report any such conflict, error, ambiguity or discrepancy if Contractor knew or reasonably should have known thereof.”

ARTICLE 4. COMMENCEMENT AND PROGRESS OF THE WORK

SC 4.01

Delete paragraph 4.01 in its entirety and insert the following in its place:

4.01 The Contract Time will commence to run on the day indicated in the Notice to Proceed.

SC-4.03.A

Add a new paragraph at the end of paragraph 4.03.A of the General Conditions which is to read as follows:

“4.03.B ENGINEER may check the lines, elevations, reference marks, batter boards, etc., set by CONTRACTOR, and CONTRACTOR shall correct any errors disclosed by such check. Such a check shall not be considered as approval of CONTRACTOR's work and shall not relieve CONTRACTOR of the responsibility for accurate and satisfactory construction and completion of the entire Work. CONTRACTOR shall furnish personnel to assist ENGINEER in checking lines and grades.”

SC-4.04

Add the following paragraph after paragraph 4.04.A.2 of the General Conditions:

"3. The CONTRACTOR's resident superintendent shall attend monthly progress meetings at the site of the work with the ENGINEER and others as appropriate to review schedule status and such other pertinent subjects as may be listed on the agenda by the ENGINEER."

SC- 4.05.A

Delete Paragraph 4.05.A in its entirety.

SC-4.05.G

Delete Paragraph 4.05.G and insert the following in its place:

“Delays caused by or within the control of the OWNER: In such event, the CONTRACTOR’S sole remedy shall be an extension of the Contract Time. Notwithstanding anything to the contrary in the Contract Documents, CONTRACTOR shall not be eligible for any increase in the Contract Price on account of any delay in the Work, no matter by whom such delay is caused, and CONTRACTOR shall make no claim for such an increase, whether such claim is styled as a claim for delay damages, acceleration of work, loss of production, or otherwise.”

ARTICLE 5. AVAILABILITY OF LANDS; SUBSURFACE AND PHYSICAL CONDITIONS; HAZARDOUS ENVIRONMENTAL CONDITIONS

SC-5.01

Add a new paragraph immediately after paragraph 5.01.A of the General Conditions which is to read as follows:

“5.01.A.1 If all lands and rights-of-way are not obtained as herein contemplated before construction begins, CONTRACTOR shall begin the Work upon such land and rights-of-way as OWNER has previously acquired and no claim for damages whatsoever will be allowed by reason of the delay in obtaining the remaining lands and rights-of-way. Should OWNER be prevented or enjoined from proceeding with the Work, or from authorizing its prosecution, either before or after the commencement, by reason of any litigation, or by reason of its inability to procure any lands or rights-of-way for the Work, CONTRACTOR shall not be entitled to make or assert claim for damage by reason of said delay, or to withdraw from the Agreement except by consent of OWNER. Time for completion of the Work will be extended as provided in Article 11, to such time as OWNER determines will compensate for the time lost by such delay.”

SC-5.01.B

Delete Paragraph 5.01.B in its entirety.

SC-5.03

In paragraph 5.03.B insert the word “reasonably” before the word “rely” in the first line and insert the following at the end of the first sentence:

“; the OWNER does not warrant or guarantee the accuracy or completeness of the information therein, and the CONTRACTOR may not so rely to the extent that the CONTRACTOR knows, or reasonably should have known, of any inaccuracy or omission therein.

SC-5.04

Insert the following paragraph before Paragraph 5.04.A

“5.04 Differing Subsurface or Physical Conditions

In accordance with Massachusetts General Laws Chapter 30, Section 39N, if, during the progress of the Work, the CONTRACTOR or the OWNER discovers that the actual subsurface or latent physical conditions encountered at the site differ substantially or materially from those shown on the plans or indicated in the Contract Documents either the CONTRACTOR or the OWNER may request an equitable adjustment in the Contract Price applying to work affected by the differing site conditions. A request for such an adjustment shall be in writing and shall be delivered by the party making such request to the other party as soon as possible after such conditions are discovered. Upon receipt of such a request from the CONTRACTOR, or upon its own initiative, the OWNER will make an investigation of such physical conditions, and if they differ substantially or materially from those shown on the plans or indicated in the Contract Documents or from those ordinarily encountered and generally recognized as inherent in work of the character provided for in the plans and Contract Documents and are of such a nature as to cause an increase or decrease in the cost of performance of the Work or a change in the construction methods required for the performance of the Work which results in an increase or decrease in the cost of the Work, the OWNER will make an equitable adjustment in the Contract Price and the Contract shall be modified in writing accordingly.”

SC-5.04.D.1

Delete Paragraph 5.04.D.1 in its entirety.

Add a new paragraph immediately after paragraph 5.04.D of the General Conditions which is to read as follows:

“5.04.E Adjustments resulting from actual subsurface or latent physical conditions from those indicated will be in accordance with Massachusetts General Law, Chapter 30, Section 39N and the applicable provisions of the Contract Documents.”

SC-5.05.A

Insert the following new paragraph immediately after Paragraph 5.05.A.2:

“3. CONTRACTOR’s attention is directed to the requirements of Massachusetts General Laws Chapter 82, Section 40, regarding the notification of owners of underground facilities.”

SC-5.05.B

Delete the phrase “or was not shown or indicated with reasonable accuracy” following the words “Contract Documents” in the first sentence of Paragraph 5.05.B.

SC-5.06.B

Delete Paragraph 5.06.B in its entirety.

SC-5.06.C

Add the following at the end of Paragraph 5.06.C:

“,or unless CONTRACTOR caused or contributed to such Hazardous Environmental Condition.”

SC-5.06.E

Delete the second and third sentences of Paragraph 5.06.E.

SC-5.06.I

Delete Paragraph 5.06.I in its entirety.

SC-5.06.J

Delete the last sentence of Paragraph 5.06.J.

ARTICLE 6. BONDS AND INSURANCE

SC-6.02

Delete Paragraph 6.02.D in its entirety.

Add a new paragraph immediately after paragraph 6.02.J of the General Conditions which is to read as follows:

"K. If OWNER has any objection to the coverage afforded by or other provisions of the insurance required to be purchased and maintained by CONTRACTOR in accordance with this Article 6 on the basis of its not complying with the Contract Documents, OWNER will notify CONTRACTOR in writing thereof within thirty days of the date of delivery of such certificates to OWNER in accordance with paragraph 2.01.B CONTRACTOR will provide such additional information in respect of insurance provided by him as OWNER may reasonably request."

SC-6.03

The limits of liability for the insurance required by paragraph 6.03 of the General Conditions shall provide the following coverages for not less than the following amounts or greater where required by Laws and Regulations:

6.03.A Workers' Compensation.

- | | |
|---------------------------|--------------------------------------|
| (1) Worker's Compensation | As required by Massachusetts statute |
|---------------------------|--------------------------------------|

(2) Employer's Liability \$1,000,000

The Workers' Compensation policy shall contain a Waiver of Subrogation in favor of the Owner.

6.03.B and 6.03.C Comprehensive General Liability including Operations/Premises, Contractor's Protective, Products/Completed Operations, and Personal Injury liabilities:

(1) Bodily injury:	\$1,000,000	Each occurrence
	\$2,000,000	Annual aggregate
(2) Property damage, including explosion, collapse and underground coverage:	\$1,000,000	Each occurrence
	\$2,000,000	Annual aggregate
Property damage liability insurance shall provide coverage for property in the care, custody and control of the insured.		
(3) Personal injury, with employment exclusion deleted:	\$2,000,000	Annual aggregate

The Contractual Liability required by paragraph 6.03.C of the General Conditions shall provide coverage for not less than the following amounts:

(1) Bodily injury:	\$1,000,000	Each occurrence
	\$2,000,000	Annual aggregate
(2) Property damage, including explosion, collapse and underground coverage:	\$1,000,000	Each occurrence
	\$2,000,000	Annual aggregate
(3) General Aggregate	\$2,000,000	

Completed Operations coverage shall be maintained for a period of three years after Substantial Completion and acceptance by Owner. The policy shall include the Owner and affiliates as Additional Insureds via endorsements CG 20 10 10 01 and CG 20 37 10 01 or equivalent, and such insurance shall be Primary and Non-Contributory with respect to any other insurance available to Additional Insureds.

A Waiver of Subrogation shall be provided in favor of the Owner via endorsement CG 24 04 05 09 or equivalent.

6.03.D Comprehensive Automobile Liability including owned, hired and non-owned vehicles:

(1) Bodily injury:	\$1,000,000	Each person
	\$1,000,000	Each accident

(2) Property damage \$1,000,000 Each occurrence

The Commercial Automobile policy shall contain a Waiver of Subrogation in favor of the Owner. The policy shall include the Owner and affiliates as Additional Insured, and such insurance shall be primary and non-contributory with respect to any other insurance available to the Additional Insured.

6.03.E Umbrella or Excess Liability

The Contractor shall provide Umbrella Liability coverage with the following limits in a form at least as broad as primary coverages required by Sections 6.3.A, B, C & D:

\$2,000,000 Each Occurrence
\$2,000,000 Annual Aggregate

To the extent provided on underlying forms, Additional Insured status shall be provided to Owner and affiliates on a Primary/Non-Contributory basis. A Waiver of Subrogation shall be provided in favor of Owner.

6.03.F Pollution Liability

The Pollution Liability policy shall contain a Waiver of Subrogation in favor of the Owner and affiliates. The policy shall include the Owner and affiliates as Additional Insured, and such insurance shall be primary and non-contributory with respect to any other insurance available to Additional Insureds. Limits required shall be as follows:

\$1,000,000 Each Claim
\$1,000,000 Annual Aggregate

SC-6.04

Delete paragraph 6.04 of the General Conditions in its entirety and insert the following in its place:

6.04.A CONTRACTOR shall purchase and maintain a separate Owner's Protective Liability policy, issued to OWNER at the expense of CONTRACTOR, including OWNER and ENGINEER as named insured. This insurance shall provide coverage for not less than the following amounts:

6.04.A.1 Bodily Injury:
Each Occurrence \$1,000,000

6.04.A.2 Property Damage:

Each Occurrence	\$1,000,000
Annual Aggregate	\$1,000,000

SC-6.05

Delete Paragraph 6.05.A of the General Conditions in its entirety and insert the following in its place:

- "A. CONTRACTOR shall purchase and maintain, until final payment, property insurance upon the Work at the site in an amount equal to the total bid price for the completed construction. This insurance shall include the interests of OWNER, CONTRACTOR, Subcontractors, ENGINEER and ENGINEER's consultants in the Work, shall insure against the perils of fire and extended coverage, shall include "all risk" insurance for physical loss and damage including theft, vandalism and malicious mischief, collapse and water damage, and shall include damages, losses and expenses rising out of or resulting from any insured loss or incurred in the repair or replacement of any insured property (including but not limited to fees and charges of engineers, architects, attorneys and other professionals). This insurance shall be provided on the completed value form. If not covered under the "all risk" insurance or otherwise provided in these Supplementary Conditions, CONTRACTOR shall purchase and maintain similar property insurance on portions of the Work stored on and off the site or in transit when such portions of the Work are to be included in an Application for Payment."

Delete Paragraph 6.05.B of the General Conditions in its entirety and insert the following in its place:

- "B. All the policies of insurance (or the certificates or other evidence thereof) required to be purchased and maintained by CONTRACTOR in accordance with paragraphs 6.05 will contain a provision or endorsement that the coverage afforded will not be canceled or materially changed or renewal refused until at least thirty days' prior written notice has been given to OWNER by certified mail and will contain waiver provisions in accordance with paragraph 6.06.B."

SC-6.05.D

Delete Paragraph 6.05.D in its entirety and insert the following:

- “OWNER may occupy or use a portion of the Work prior to Substantial Completion.”

SC-6.06A

Delete Paragraph 6.06A in its entirety and insert the following:

- “OWNER and CONTRACTOR intend that all policies of insurance purchased in accordance with the provisions of Article 6 will protect OWNER, CONTRACTOR, Subcontractors, and ENGINEER, and all other individuals or entities identified in the Supplementary Conditions as loss payees (and officers, director, members, partners, employees, agents, consultants, and subcontractors or each and any of them) in such

policies and will, where required to provided such insurance, provide primary coverage for all losses and damages caused by the perils or causes of loss covered thereby.”

SC-6.06.C

Delete Paragraph 6.06.C in its entirety and replace with the following:

“The CONTRACTOR shall pay for all costs not covered because of the application of a policy deductible due under any of its insurance policies required hereunder.”

SC-6.07

Delete paragraph 6.07.A of the General Conditions in its entirety.

Delete paragraph 6.07.B of the General Conditions in its entirety.

Delete paragraph 6.07.C of the General Conditions in its entirety.

ARTICLE 7. CONTRACTOR'S RESPONSIBILITIES

SC-7.01

Add the following new paragraph as follows:

“7.01.C The site superintendent may be a direct employee of the subcontractor provided that this individual has the full authority and responsibility of the general contractor’s specified superintendent. The General Contractor shall submit a letter to the District and the Engineer stating who the supervisor is and defining his/her authority during all construction related activities.”

SC-7.02.C – 7.02.G

Insert the following new paragraphs immediately after Paragraph 7.02.B:

“C. Regular working hours are defined as Monday through Friday, excluding holidays, between the hours of 7:00 AM and 5:00 PM. Requests to work other than regular working hours shall be submitted to ENGINEER not less than 48 hours prior to any proposed change. Occasional unscheduled overtime on weekdays may be permitted provided it is approved by ENGINEER.”

“D. CONTRACTOR shall reimburse the OWNER for additional engineering and/or inspection costs incurred as a result of overtime work in excess of the regular working hours stipulated in Paragraph SC-7.02.C. At OWNER’s option, overtime costs may either be deducted from the CONTRACTOR’s monthly payment or deducted from the retainage held by OWNER until release of final payment. Overtime costs for the OWNER’s personnel shall be based on the individual’s current overtime wage rate. Overtime costs for personnel employed by the ENGINEER or OWNER’s independent testing laboratory shall be calculated in accordance with the terms of their respective contracts with the OWNER.”

“E. This agreement is subject to the applicable provisions of the Contract Work Hours and Safety Standards Act, Public Law 87-581 87th Congress. No Contractor or

Subcontractor contracting for any part of the Work shall require or permit any laborer or mechanic to be employed on the Work in excess of forty hours in any work week unless such laborer or mechanic receives compensation at a rate not less than one and one-half times that person's basic rate of pay for all hours worked in excess of forty hours in such work week."

"F. CONTRACTOR and Subcontractors shall, insofar as practicable, give preference in the hiring of workers for the Project to qualified local residents with first preference being given to citizens of the United States who have served in the armed forces of the United States and have been honorably discharged therefrom or released from active duty therein.

"G. CONTRACTOR shall employ only competent persons to do the work and whenever OWNER shall notify CONTRACTOR, in writing, that any person on the Work appears to be incompetent, disorderly, or otherwise unsatisfactory, such person shall be removed from the Project and shall not again be employed on it except with the consent of OWNER."

SC-7.04.A

Insert the following at the end of the third sentence of Paragraph 7.04.A:

" , and in accordance with G.L. c.30, §39M."

Add a new paragraph SC-7.04.A.1.c immediately after paragraph 7.04A.1.b, which is to read as follows:

"c. It shall be CONTRACTOR's responsibility to coordinate all submittals to ENGINEER for approval to eliminate any conflicts which might arise due to the use of "or equal" items. Any additional costs incidental to the use of "or equal" items shall be paid by CONTRACTOR."

SC-7.06

Add the following to Paragraph 7.06.A:

"CONTRACTOR shall not employ any Subcontractor, Supplier or other person or organization, (including those who are to furnish the principal items of materials or equipment), whether initially or as a substitute, against whom OWNER makes reasonable objection. Acceptance of any Subcontractor, other person or organization by OWNER shall not constitute a waiver of any right of OWNER to reject defective Work."

7.06.H.1

Add the following paragraph immediately after paragraph 7.06.H:

1. CONTRACTOR shall make payments to Subcontractors in accordance with Massachusetts General Laws Chapter 30, Section 39F."

Add the following new paragraph as follows:

"7.06.J.1 OWNER or ENGINEER may furnish to any such Subcontractor, Supplier, or other person or organization, to the extent practicable, information about amounts paid to

CONTRACTOR in accordance with CONTRACTOR's Applications for Payment on account of the particular Subcontractor's, Suppliers, other person's, or other organization's Work."

SC-7.06

Add the following language at the beginning of paragraph 7.06.L of the General Conditions:

"Except as otherwise required by Massachusetts General Law, Chapter 149, Section 44F,"

SC-7.07.A

Delete the second sentence of Paragraph 7.07.A.

SC-7.07.B

Delete this subparagraph.

SC-7.09

Add the following language at the end of paragraph 7.09.A of the General Conditions:

"7.09.A.1 The materials and supplies to be used in the Work under this Contract are exempt from the Sales and Use Tax of the Commonwealth of Massachusetts. Contractor shall obtain the proper certificates, maintain the necessary records, and otherwise comply with all applicable requirements governing the exemption from sales tax."

SC-7.10C

Delete the last sentence of Paragraph 7.10C.

SC-7.11.B – C

Insert the following new paragraphs immediately after Paragraph 7.11.A:

"B. The CONTRACTOR shall return to the ENGINEER one set of the Contract Drawings marked in colored pencil, showing all changes made during construction and including the location, by dimensions and elevations, of installed equipment, and underground facilities that will become concealed or buried by the construction. This shall include ties to all concealed work, etc. measured from permanent structures. Additionally, the CONTRACTOR shall be required to keep marked-up drawings current and on site and to provide mark-ups to the OWNER on a monthly basis.

"C. CONTRACTOR shall comply with all applicable provisions of Chapter 30, Section 39R of the Massachusetts General Laws regarding CONTRACTOR's records."

SC-7.12.E

Delete the text in parentheses in Paragraph 7.12.E.

SC-7.16

Add the following new paragraph immediately after paragraph 7.16.E of the General Conditions, which is to read as follows:

“7.16.F The accuracy of all such information submitted by the Contractor is the responsibility of the Contractor. In reviewing Shop Drawings, Samples, and similar submittals, the Engineer shall be entitled to rely upon the Contractor’s representation that such information is correct and accurate.”

SC-7.17.E

Add the following new paragraph 7.17.E, immediately after paragraph 7.17.D of the General Conditions:

“E. CONTRACTOR shall guarantee all materials and equipment furnished and Work performed for a period of two (2) years from the date of Substantial Completion. CONTRACTOR warrants and guarantees for a period of two (2) years from the date of Substantial Completion that the completed Work is free from all defects due to faulty materials or workmanship and CONTRACTOR shall promptly make such corrections as may be necessary by reason of any such defects including the repairs of any damage to other parts of the Work resulting from such defects. In the event that CONTRACTOR should fail to make such repairs, adjustments, or other work that may be made necessary by such defects, OWNER may do so and charge CONTRACTOR the cost thereby incurred. The Performance Bond shall remain in full force and effect through the guarantee period.”

SC-7.18.A

Delete the phrase in parentheses: “(other than the Work itself)” in Paragraph 7.18.A.

Change the phrase “negligent act or omission” to “negligent or willful or wrongful act or omission.”

SC-7.18.B

Insert the following at the end of Paragraph 7.18.B:

“If, through the acts or neglect of CONTRACTOR, any other Contractor or any Subcontractor shall suffer loss or damage on the Work, CONTRACTOR shall settle with such other Contractor or Subcontractor by agreement if such other Contractor or Subcontractor will so settle. If such other Contractor or Subcontractor shall assert any claim against OWNER on account of any damage alleged to have been sustained, OWNER shall notify CONTRACTOR, who shall indemnify and hold harmless OWNER against any such claims.”

ARTICLE 8. OTHER WORK AT THE SITE

SC-8.02

Delete Paragraph 8.02 in its entirety.

SC-8.03

Delete paragraph 8.03.D of the General Conditions in its entirety, and insert the following in its place:

“8.03.D Should CONTRACTOR cause damage to the work or property of any separate contractor at the site, or should any claim arising out of CONTRACTOR'S performance of the Work at the site be made by any separate contractor against CONTRACTOR, OWNER, ENGINEER, ENGINEER'S Consultants, or any other person, CONTRACTOR shall promptly attempt to settle with such other contractor by agreement, or to otherwise resolve the dispute by arbitration or at law. CONTRACTOR shall, to the fullest extent permitted by Laws and Regulations, indemnify and hold OWNER, ENGINEER, and ENGINEER'S Consultants, harmless from and against all claims, damages, losses, and expenses (including, but not limited to, fees of engineers, architects, attorneys, and other professionals, and court and arbitration costs) arising directly, indirectly, or consequentially out of any action, legal or equitable, brought by any separate contractor against OWNER, ENGINEER, or ENGINEER'S Consultants, to the extent based on a claim arising out of the CONTRACTOR'S performance of the Work. Should a separate contractor cause damage to the Work or property of CONTRACTOR or should the performance of Work by any separate contractor at the site give rise to any other claim, CONTRACTOR shall not institute any action, legal or equitable, against OWNER, ENGINEER, or ENGINEER'S Consultants or permit any action against any of them to be maintained and continued in its name or for its benefit in any court or before any arbiter which seeks to impose liability on or to recover damages from OWNER, ENGINEER, or ENGINEER'S Consultants, on such action or claim. If CONTRACTOR is delayed at any time in performing or furnishing Work by any act or neglect of a separate contractor and OWNER and CONTRACTOR are unable to agree to the extent of any adjustment in Contract Times attributable thereto, CONTRACTOR may make a claim for an extension of times in accordance with Article 12.02. An extension of the Contract Times shall be CONTRACTOR'S exclusive remedy with respect to OWNER, ENGINEER, and ENGINEER'S Consultants, for any delay, disruption, interference or hindrance caused by any separate contractor. This paragraph does not prevent recovery from OWNER, ENGINEER, or ENGINEER'S Consultant, for activities that are their respective responsibilities.”

ARTICLE 9. OWNER'S RESPONSIBILITIES

SC-9.02.A

Delete the phrase “provided Contractor makes no reasonable objection to the replacement engineer” in Paragraph 9.02.A.

SC-9.06

Delete paragraph 9.06 of the General Conditions in its entirety.

SC-9.09

Insert the following after the first sentence of Paragraph 9.09.A:

“However, the OWNER shall have the right to direct the CONTRACTOR to perform the Work according to any sequence schedule set forth in the Contract Documents or established pursuant thereto.”

ARTICLE 10. ENGINEER'S STATUS DURING CONSTRUCTION

SC-10.01

Add a new paragraph 10.01.B after paragraph 10.01.A of the General Conditions, which is to read as follows:

"B. Nothing contained in the Contract Documents shall be construed to create a contractual relationship of any kind (1) between the ENGINEER and CONTRACTOR, (2) between the OWNER and a Subcontractor or Subcontractors, or (3) between any person or entities other than the OWNER and CONTRACTOR. The ENGINEER shall, however, be entitled to performance and enforcement of obligations under the CONTRACT DOCUMENTS intended to facilitate performance of the ENGINEER'S duties."

SC-10.02B

Insert the following at the end of Paragraph 10.02.B:

“However, the ENGINEER shall have the right to direct the CONTRACTOR to perform the Work according to any sequence schedule set forth in the Contract Documents or established pursuant thereto.”

SC-10.03

Delete the last sentence of Paragraph 10.03.A

Add a new paragraph immediately after paragraph 10.03.A of the General Conditions as follows:

“10.03.B ENGINEER will furnish a Resident Project Representative and assistants to assist ENGINEER in observing the performance of the Work. The duties and responsibilities of the Resident Project Representative will be as enumerated in a document entitled "Duties, Responsibilities, and Limitations of the Authority of Resident Project Representative" and will be made available to CONTRACTOR at the start of his work.”

SC-10.08.B

Insert the following after the first sentence in Paragraph 10.08.B:

“However, the ENGINEER shall have the right to direct the CONTRACTOR to perform the Work according to any sequence schedule set forth in the Contract Documents or established pursuant thereto.”

SC-10.08.F

Add a new paragraph immediately after paragraph 10.08.E of the General Conditions which is to read as follows:

“ENGINEER'S interpretations will be made in accordance with Massachusetts General Laws Chapter 30, Section 39P.”

ARTICLE 11. AMENDING THE CONTRACT DOCUMENTS; CHANGES IN THE WORK

SC-11.02

Add a new paragraph immediately after paragraph 11.02.A of the General Conditions which is to read as follows:

“11.02.A.1 ENGINEER'S interpretations will be made in accordance with Massachusetts General Law, Chapter 30, Section 39P.”

SC-11.02

Add the following new paragraph immediately after paragraph 11.02.A of the General Conditions, which is to read as follows:

“11.02.B Upon request of the Owner or Engineer, the Contractor shall without cost to the Owner submit to the Engineer, in such form as the Engineer may require, an accurate written estimate of the cost of any such proposed extra Work or change. The estimate shall indicate the quantity and unit cost of each item of materials, and the number of hours of work and hourly rate for each class of labor, as well as the description and amounts of all other costs chargeable under the terms of this Article. Unit labor costs for the installation of each item of materials shall be shown if required by the Engineer. The Contractor shall promptly revise and resubmit such estimate if the Engineer determines that it is not in compliance with the requirements of this Article, or that it contains errors of facts or mathematical errors. If required by the Engineer, in order to establish the exact cost of new Work added or previously required Work omitted, the Contractor shall obtain and furnish to the Engineer bona fide proposals from recognized suppliers for furnishing any material included in such Work, and shall be furnished at Contractor's expense. The Contractor shall state in the estimate any extension of time required for the completion of the Work if the change or extra work is ordered.”

SC-11.04

In paragraph 11.04.C.2.a change “15 percent” to “10 percent”.

Delete paragraph 11.04.C.2.c

ARTICLE 12. CLAIMS

SC-12.01

Add a new paragraph immediately after paragraph 12.01.D.1 of the General Conditions to read as follows:

“12.01.D.1.a CONTRACTOR shall carry on the Work and maintain the progress schedule during the dispute resolution proceedings unless otherwise agreed in writing by OWNER and CONTRACTOR.”

ARTICLE 13. COST OF THE WORK; ALLOWANCES; UNIT PRICE WORK

SC-13.01

Add the following to the end of paragraph 13.01.B of the General Conditions to read as follows:

“Following the Notice of Award and prior to the execution of the AGREEMENT the OWNER, prospective contractor and, if any, each prospective filed subbid contractor shall agree on what percentage markup shall be used as direct labor costs in determination of extra work costs.”

In the second sentence of paragraph 13.01.B.1 delete the word "superintendents".

SC-13.01.B.5

Delete subparagraphs a, d, e, f, g, and h of Paragraph 13.01.B.5.

SC-13.03.E

Delete Paragraph 13.03.E in its entirety.

SC-13.02

Delete paragraph 13.02 of the General Conditions in its entirety.

SC-13.03.E

Delete Paragraph 13.03.E in its entirety.

ARTICLE 14. TESTS AND INSPECTIONS; CORRECTION, REMOVAL OR ACCEPTANCE OF DEFECTIVE WORK

SC-14.02.F

Delete the remainder of Paragraph 14.02.F after the words “Contractor’s expense.”

SC-14.05.C.2

Delete Paragraph 14.05.C.2 in its entirety.

SC-14.06.B

Insert the following new paragraph immediately after Paragraph 14.06.A:

“B. If Owner stops Work under paragraph 14.06.A, CONTRACTOR shall not be entitled to any extension of Contract Time or increase in Contract Price.”

**ARTICLE 15. PAYMENTS TO CONTRACTOR; SET-OFFS; COMPLETION;
CORRECTION PERIOD**

SC-15.01

Delete the first phrase prior to the words “Contractor shall” in the first sentence of Paragraph 15.01.B.1 and insert the following:

“On a monthly basis and in accordance with G.L. c.30, §39G,”.

Delete paragraph 15.01.B.3 and insert the following in its place:

"15.01.B.3. Retainage with respect to progress payments will be five percent or, if stipulated, the maximum allowed by law."

SC-15.01.B.4

Insert the following new paragraph immediately after Paragraph 15.01.B.3:

“4. CONTRACTOR shall furnish evidence that payment received on the basis of materials and equipment not incorporated and suitably stored, has in fact been paid to the respective supplier(s) within ten (10) days of payment by OWNER. Failure to provide such evidence of payment may result in the withdrawal of previous approval(s) and removal of the cost of related materials and equipment from the next submitted Application for Payment.

SC-15.01.C.1

Delete Paragraph 15.01C.1 and insert the following:

“1. Progress Payments shall be made in accordance with Massachusetts General Laws, Chapter 30, Section 39G.”

SC-15.01.D.1

Delete Paragraph 15.01.D.1 and insert the following:

“1. Payment shall be made in accordance with G.L. c.30, §39G.”

SC-15.01.E.2

Delete the words “immediate” and “promptly” in the first sentence of Paragraph 15.01.E.2.

SC-15.01.E.3

Delete this Paragraph in its entirety.

SC-15.02

Insert the following new paragraphs immediately after Paragraph 15.02.A:

- “B. No materials or supplies for the Work shall be purchased by CONTRACTOR or Subcontractor subject to any chattel mortgage or under a conditional sale contract or other agreement by which an interest is retained by the seller. CONTRACTOR warrants that CONTRACTOR has good title to all materials and supplies used by CONTRACTOR in the Work, free from all liens, claims or encumbrances.”
- “C. CONTRACTOR shall indemnify and save OWNER harmless from all claims growing out of the lawful demands of Subcontractors, laborers, workmen, mechanics, materialmen, and furnishers of machinery and parts thereof, equipment, power tools, and all supplies, including commissary, incurred in the furtherance of the performance of this Contract. CONTRACTOR shall, at OWNERS request, furnish satisfactory evidence that all obligations of the nature hereinabove designated have been paid, discharged, or waived. If CONTRACTOR fails to do so, then OWNER may, after having served written notice on the CONTRACTOR, either pay unpaid bills, of which OWNER has written notice, or withhold from the CONTRACTOR’s unpaid compensation a sum of money deemed reasonably sufficient to pay any and all such lawful claims until satisfactory evidence is furnished that all liabilities have been fully discharged whereupon payment to CONTRACTOR shall be resumed, in accordance with the terms of this Contract, but in no event shall the provisions of this sentence be construed to impose any obligation upon OWNER to either CONTRACTOR, or CONTRACTOR’s Surety. In paying any unpaid bills of the CONTRACTOR, OWNER’s payment shall be considered as payment made under the Contract by OWNER to CONTRACTOR and OWNER shall not be liable to CONTRACTOR for any such payment made in good faith.”

SC-15.03.C

Delete the third sentence of Paragraph 15.03.C and insert the following:

“OWNER may review the preliminary certificate and make written objection to ENGINEER as to any provisions of the certificate or attached list.”

Delete the phrase “, within 14 days after submission of the preliminary certificate to OWNER,” in the fourth sentence of paragraph 15.03.C.

Delete the phrase “, within said 14 days,” in the fifth sentence of Paragraph 15.03.C.

SC-15.04.A

Delete the phrase “subject to the following conditions” at the end of the first sentence of Paragraph 15.04.A.

Delete Paragraph 15.04.A.2 in its entirety.

SC-15.06

Delete Paragraph 15.06.B.1 and insert the following:

- “1. If, on the basis of ENGINEER’s observations of the Work during construction and final inspection, and ENGINEER’s review of the final Application for Payment and accompanying documentation, all as required by the Contract Documents, ENGINEER is satisfied that the Work has been completed and CONTRACTOR’s other obligations under the Contract Documents have been fulfilled, ENGINEER will indicate in writing ENGINEER’s recommendation of payment and present the Application for Payment to OWNER for payment. Thereupon ENGINEER will give written notice to OWNER and CONTRACTOR that the Work is acceptable subject to the provisions of paragraph 15.07. Otherwise, ENGINEER will return the Application for Payment to CONTRACTOR, indicating in writing the reasons for refusing to recommend final payment, in which case CONTRACTOR shall make the necessary corrections and resubmit the Application for Payment.

SC-15.06.D

Insert the following at the end of Paragraph 15.06.D:

“Final payment shall be made in accordance with G.L. c.30, §39G.”

ARTICLE 16. SUSPENSION OF WORK AND TERMINATION

SC-16.01.A

Delete Paragraph 16.01.A in its entirety and insert the following:

- “A. OWNER may suspend the work or any portion thereof in accordance with G.L. c.30, §39O.”

SC-16.02.A.5

Insert new paragraph immediately after Paragraph 16.02.A.4:

- “5. If CONTRACTOR abandons the Work, or sublets this Contract or any part thereof, without the previous written consent of OWNER, or if the Contract or any claim thereunder shall be assigned by CONTRACTOR otherwise than as herein specified.”

SC-16.03.A.1

Delete the phrase “including fair and reasonable sums for overhead and profit on such Work” in Paragraph 16.03.A.1.

SC-16.03.A.2

Delete the phrase “plus fair and reasonable sums for overhead and profit on such expenses” in Paragraph 16.03.A.2.

SC-16.03.A.3

Delete Paragraph 16.03.A.3 in its entirety.

SC-16.04.B

Delete the last sentence of Paragraph 16.04.B.

ARTICLE 17. FINAL RESOLUTION OF DISPUTES

SC-17.01.C

Insert a new sub-paragraph after Paragraph 17.01.B:

“CONTRACTOR shall be responsible to carry on the Work and maintain the progress schedule during the dispute resolution proceedings.”

SC-17.02

Add a new paragraph immediately after Paragraph 17.01 of the General Conditions which is to read as follows:

“17.02 Venue

Any legal action relating to this Contract shall be filed in the Superior Court for the County in the Commonwealth of Massachusetts in which the Project is located, unless otherwise agreed by CONTRACTOR and OWNER in writing.”

ARTICLE 18. MISCELLANEOUS

SC-18.08

18.08 Headings:

Delete paragraph 18.08.A and replace with the following paragraph:

“18.08.A The headings or titles of any article, paragraph, subparagraph, section, subsection, or part of the Contract Documents shall not be deemed to limit or restrict the article, paragraph, section, or part.”

SC-18.10

Insert the following new paragraph:

“SC-18.10 Wage Rates

- “A. The requirements and provisions of all applicable laws and any amendments thereof or additions thereto as to employment of labor, and to the schedule of minimum wage rates established in compliance with laws shall be a part of the Contract Documents. If after the Notice of Award, it becomes necessary to employ any person in a trade or occupation not classified in the wage determinations, such person shall be paid at not less than such rates as shall be determined by the officials administering the laws mentioned above.”
- “B. The schedule of wages referred to above is minimum rates only, and OWNER will not consider any claims for additional compensation made by CONTRACTOR because of payment by CONTRACTOR of any wage in excess of the applicable, required rates.”
- “C. The said schedules of wages shall continue to be the minimum rates to be paid during the life of this Agreement, unless state laws and regulations require updating the same in which case the Owner shall provide the updated applicable schedule of wages, and a legible copy of said schedules shall be kept posted in a conspicuous place at the site of the work.”

SECTION 00850

**Excerpts from Chapter 149 and Chapter 30 of the
Massachusetts General Laws**

Certain excerpts from the Massachusetts General Laws are applicable to Construction contracts. Attention is directed to the following Sections of Chapter 149 as amended:

Section 25. "Every employee in public work shall lodge, board, and trade where and with whom he elects; and no person or his agents or employees under contract with the commonwealth, a county, city or town, or with a department, board, commission or officer acting therefor, for the doing of public work shall directly or indirectly require, as a condition of employment therein, that the employee shall lodge, board or trade at a particular place or with a particular person. This section shall be made a part of the contract for such employment."

Section 26. "In the employment of mechanics and apprentices, teamsters, chauffeurs and laborers in the construction of public works by the commonwealth, or by a county, town or district, or by persons contracting or subcontracting for such works, preference shall first be given to citizens of the commonwealth who have been residents of the commonwealth for at least six months at the commencement of their employment who are male veterans as defined in clause Forty-third of section seven of chapter four, and who are qualified to perform the work to which the employment relates; and secondly, to citizens of the commonwealth generally who have been residents of the commonwealth for at least six months at the commencement of their employment, and if they cannot be obtained in sufficient numbers, then to citizens of the United States, and every contract for such work shall contain a provisions to this effect..."

Section 34. "Every contract, except for the purchase of material or supplies, involving the employment of laborers workmen, mechanics, foremen or inspectors, to which the commonwealth or any county or any town, subject to section thirty, is a party, shall contain a stipulation that no laborer, workman, mechanic, foreman or inspector working within the commonwealth, in the employ of the contractor, subcontractor or other person doing or contracting to do the whole or a part of the work contemplated by the contract, shall be required or permitted to work more than eight hours in any one-day or more than forty-eight hours in any one week, or more than six-days in any one week, except in cases of emergency, or in case any town subject to section thirty-one is a party to such a contract, more than eight hours in any one-day except as aforesaid..."

Section 34A. "Every contract for the construction, alteration, maintenance, repair or demolition of or addition to, any public building or other public works for the commonwealth or any political subdivision thereof shall contain stipulations requiring that the contractor shall, before commencing performance of such contract, provide by insurance for the payment of compensation and the furnishing of other benefits under chapter one hundred and fifty-two to all persons to be employed under the contract, and that the contractor shall continue such insurance in full force and effect during the term of

the contract. No officer or agent contracting in behalf of the commonwealth or any political subdivision thereof shall award such a contract until he has been furnished with sufficient proof of compliance with the aforesaid stipulations. Failure to provide and continue in force such insurance as aforesaid shall be deemed a material breach of the contract and shall operate as an immediate termination thereof. No cancellation of such insurance, whether by the insurer or by the insured, shall be valid unless written notice thereof is given by the party proposing cancellation to the other party and to the officer or agent who awarded the contract at least fifteen-days prior to the intended effective date thereof, which date shall be expressed in said notice. Notice of cancellation sent by the party proposing cancellation by registered mail, postage prepaid, with a return receipt of the addressee requested, shall be a sufficient notice..."

Section 34B. "Every contract for the construction, alteration, maintenance, repair or demolition of, or addition to, any public works for the commonwealth or any political subdivision thereof shall contain stipulations requiring that the contractor shall pay to any reserve police officer employed by him in any city or town the prevailing rate of wage paid to regular police officers employed by him in such city or town."

Attention is directed to the following sections of Chapter 30 of the General Laws of Massachusetts as amended to date:

Section 39F. "(1) Every contract awarded pursuant to sections forty-four A to L inclusive, of chapter one hundred and forty-nine shall contain the following subparagraphs (a) through (i) and every contract awarded pursuant to section thirty-nine M of chapter thirty shall contain the following subparagraphs (a) through (h) and in each case those subparagraphs shall be binding between the general contractor and each subcontractor."

- "(a) Forthwith after the general contractor receives payment on account of a periodic estimate, the general contractor shall pay to each subcontractor the amount paid for the labor performed and the materials furnished by that subcontractor, less any amount specified in any court proceedings barring such payment and also less any amount claimed due from the subcontractor by the general contractor.

- "(b) Not later than the sixty-fifth-day after each subcontractor substantially completes his work in accordance with the plans and specifications, the entire balance due under the subcontract less amounts retained by the awarding authority as the estimated cost of completing the incomplete and unsatisfactory items of work, shall be due the subcontractor; and the awarding authority shall pay that amount to the general contractor. The general contractor shall forthwith pay to the subcontractor the full amount received from the awarding authority less any amount specified in any court proceedings barring such payment and also less any amount claimed due from the subcontractor by the general contractor.

- "(c) Each payment made by the awarding authority to the general contractor pursuant to subparagraphs (a) and (b) of this paragraph for the labor performed and the materials furnished by a subcontractor shall be made to the general contractor for the account of that subcontractor; and the awarding authority shall take reasonable steps to compel the general contractor to make each such payment to each such subcontractor. If the awarding authority has received a demand for direct payment from a subcontractor for any amount which has already been included in a payment to the general contractor or which is to be included in a payment to the general contractor for payment to the subcontractor as provided in subparagraphs (a) and (b), the awarding authority shall act upon the demand as provided in this section.
- "(d) If, within seventy-days after the subcontractor has substantially completed the subcontract work, the subcontractor has not received from the general contractor the balance due under the subcontract including any amount due for extra labor and materials furnished to the general contractor, less any amount retained by the awarding authority as the estimated cost of completing the incomplete and unsatisfactory items of work, the subcontractor may demand direct payment of that balance from the awarding authority. The demand shall be by a sworn statement delivered to or sent by certified mail to the awarding authority, and a copy shall be delivered or sent by certified mail to the general contractor at the same time. The demand shall contain a detailed breakdown of the balance due under the subcontract and also a statement of the status of completion of the subcontract work. Any demand made after substantial completion of the subcontract work shall be valid even if delivered or mailed prior to the seventieth-day after the subcontractor has substantially completed the subcontract work. Within ten-days after the subcontractor has delivered or so mailed the demand to the awarding authority and delivered or so mailed a copy to the general contractor, the general contractor may reply to the demand. The reply shall be by a sworn statement delivered to or sent by certified mail to the awarding authority and a copy shall be delivered to or sent by certified mail to the subcontractor at the same time. The reply shall contain a detailed breakdown of the balance due under the subcontract including any amount due for extra labor and materials furnished to the general contractor and of the amount due for each claim made by the general contractor against the subcontractor.
- "(e) Within fifteen-days after receipt of the demand by the awarding authority, but in no event prior to the seventieth-day after substantial completion of the subcontract work, the awarding authority shall make direct payment to the subcontractor of the balance due under the subcontract including any amount due for extra labor and materials furnished to the general contractor, less any amount (i) retained by the awarding authority as the estimated cost of completing the incomplete or unsatisfactory items of

work, (ii) specified in any court proceedings barring such payment, or (iii) disputed by the general contractor in the sworn reply; provided, that the awarding authority shall not deduct from a direct payment any amount as provided in part (iii) if the reply is not sworn to, or for which the sworn reply does not contain the detailed breakdown required by subparagraph (d). The awarding authority shall make further direct payments to the subcontractor forthwith after the removal of the basis for deductions from direct payments made as provided in parts (i) and (ii) of this subparagraph.

- "(f) The awarding authority shall forthwith deposit the amount deducted from a direct payment as provided in part (iii) of subparagraph (e) in an interest-bearing joint account in the names of the general contractor and the subcontractor in a bank in Massachusetts selected by the awarding authority or agreed upon by the general contractor and the subcontractor and shall notify the general contractor and the subcontractor of the date of the deposit and the bank receiving the deposit. The bank shall pay the amount in the account, including accrued interest, as provided in an agreement between the general contractor and the subcontractor or as determined by decree of a court of competent jurisdiction.
- "(g) All direct payments and all deductions from demands for direct payments deposited in an interest-bearing account or accounts in a bank pursuant to subparagraph (f) shall be made out of amounts payable to the general contractor at the time of receipt of a demand for direct payment from a subcontractor and out of amounts which later become payable to the general contractor and in the order of receipt of such demands from subcontractors. All direct payments shall discharge the obligation of the awarding authority to the general contractor to the extent of such payment.
- "(h) The awarding authority shall deduct from payments to a general contractor amounts which, together with the deposits in interest-bearing accounts pursuant to subparagraph (f), are sufficient to satisfy all unpaid balances of demands for direct payment received from subcontractors. All such amounts shall be earmarked for such direct payments, and the subcontractors shall have a right in such deductions prior to any claims against such amounts by creditors of the general contractor.
- "(i) If the subcontractor does not receive payment as provided in subparagraph (a) or if the general contractor does not submit a periodic estimate for the value of the labor or materials performed or furnished by the subcontractor and the subcontractor does not receive payment for same when due less the deductions provided for in subparagraph (a), the subcontractor may demand direct payment by following the procedure in subparagraph (d) and the general contractor may file a sworn replay as provided in that same subparagraph. A demand made after the first-day of

the month following that for which the subcontractor performed or furnished the labor and materials for which the subcontractor seeks payment shall be valid even if delivered or mailed prior to the time payment was due on a periodic estimate from the general contractor. Thereafter the awarding authority shall proceed as provided in subparagraph (e), (f), (g), and (h)."

Section 39G. "Upon substantial completion of the work required by a contract with the commonwealth, or any agency or political subdivision thereof, for the construction, reconstruction, alteration, remodeling, repair or improvement of public ways, including bridges and other highway structures, sewers and water mains, airports and other public works, the contractor shall present in writing to the awarding authority its certification that the work has been substantially completed. Within twenty-one-days thereafter, the awarding authority shall present to the contractor either a written declaration that the work has been substantially completed or an itemized list of incomplete or unsatisfactory work items required by the contract sufficient to demonstrate that the work has not been substantially completed. The awarding authority may include with such list a notice setting forth a reasonable time, which shall not in any even be prior to the contract completion date, within which the contractor must achieve substantial completion of the work. In the event that the awarding authority fails to respond by presentation of a written declaration or itemized list as aforesaid, to the contractor's certificate within the twenty-one-day period, the contractor's certification shall take effect as the awarding authority's declaration that the work has been substantially completed.

"Within sixty-five-days after the effective date of a declaration of substantial completion, the awarding authority shall prepare and forthwith send to the contractor for acceptance a substantial completion estimate for the quantity and price of the work done and all but one percent retainage on that work, including the quantity, price and all but one percent retainage for the undisputed part of each work item and extra work item in dispute but excluding the disputed part thereof, less the estimated cost of completing all incomplete and unsatisfactory work items and less the total periodic payments made to date for the work. The awarding authority also shall deduct from the substantial completion estimate an amount equal to the sum of all demands for direct payment filed by subcontractors and not yet paid to subcontractors or deposited in joint accounts pursuant to section thirty-nine F, but no contract subject to said section thirty-nine F shall contain any other provisions authorizing the awarding authority to deduct any amount by virtue of claims asserted against the contract by subcontractors, material suppliers or other.

"If the awarding authority fails to prepare and send to the contractor any substantial completion estimate required by this section on or before the date hereinabove set forth, the awarding authority shall pay to the contractor interest on the amount which would have been due to the contractor pursuant to such substantial completion estimate at the rate of three percentage points above the rediscount rate then charged by the Federal Reserve Bank of Boston from such date to the date on which the awarding authority sends that substantial completion estimate to the contractor for acceptance or to the date

of payment therefor, whichever occurs first. The awarding authority shall include the amount of such interest in the substantial completion estimate.

"Within fifteen-days after the effective date of the declaration of substantial completion, the awarding authority shall send to the contractor by certified mail, return receipt requested, a complete list of all incomplete or unsatisfactory work items, and, unless delayed by causes beyond his control, the contractor shall complete all such work items within forty-five-days after the receipt of such list or before the then contract completion date, whichever is later. If the contractor fails to complete such work within such time, the awarding authority may, subsequent to seven-days' written notice to the contractor by certified mail, return receipt requested, terminate the contract and complete the incomplete or unsatisfactory work items and charge the cost of same to the contractor.

"Within thirty-days after receipt by the awarding authority of a notice from the contractor stating that all of the work required by the contract has been completed, the awarding authority shall prepare and forthwith send to the contractor for acceptance a final estimate for the quantity and price of the work done and all retainage on that work less all payments made to date, unless the awarding authority's inspection shows that work items required by the contract remain incomplete or unsatisfactory, or that documentation required by the contract has not been completed. If the awarding authority fails to prepare and send to the contractor the final estimate within thirty-days after receipt of notice of completion, the awarding authority shall pay to the contractor interest on the amount which would have been due to the contractor pursuant to such final estimate at the rate hereinabove provided from the thirtieth-day after such completion until the date on which the awarding authority sends the final estimate to the contractor for acceptance or the date of payment therefor, whichever occurs first, provided that the awarding authority's inspection shows that not work items required by the contract remain incomplete or unsatisfactory. Interest shall not be paid hereunder on amounts for which interest is required to be paid in connection with the substantial completion estimate as hereinabove provided. The awarding authority shall include the amount of the interest required to be paid hereunder in the final estimate.

"The awarding authority shall pay the amount due pursuant to any periodic, substantial completion or final estimate within thirty-five-days after receipt of written acceptance for such estimate from the contractor and shall pay interest on the amount due pursuant to such estimate at the rate hereinabove provided from that thirty-fifth-day to the date of payment. In the case of periodic payment, the contracting authority may deduct from its payment a retention based on its estimate of the fair value of its claim against the contractor, a retention for direct payments to subcontractors based on demands for same in accordance with the provisions of section thirty-nine F, and a retention to secure satisfactory performance of the contractual work not exceeding five percent of the approved amount of any periodic payments, and the same right to retention shall apply to bonded subcontractors entitled to direct payment under section thirty-nine F of chapter thirty; provided that a five percent value of all items that are planted in the ground shall be deducted from the periodic payments until final acceptance.

"No periodic, substantial completion or final estimate or acceptance or payment thereof shall bar a contractor from reserving all rights to dispute the quantity and amount of, or the failure of the awarding authority to approve a quantity and amount of, all or part of any work item or extra work item.

"Substantial completion, for the purposes of this section, shall mean either that the work required by the contract has been completed except for work having a contract price of less than one percent of the then adjusted total contract price, or substantially all of the work has been completed and opened to public use except for minor incomplete or unsatisfactory work items that do not materially impair the usefulness of the work required by the contract."

Section 39K. "Every contract for the construction, reconstruction, alteration, remodeling, repair or demolition of any public building by the commonwealth, or by any county, city, town, district, board, commission or other public body, when the amount is more than five thousand dollars in the case of the commonwealth and more than two thousand dollars in the case of any county, city, town, district, board, commission or public body, shall contain the following paragraph: Within fifteen-days (twenty-four-days in the case of the commonwealth) after receipt from the contractor, at the place designated by the awarding authority if such a place is so designated, of a periodic estimate requesting payment of the amount due for the preceding month, the awarding authority will make a periodic payment to the contractor for the work performed during the preceding month and for the materials not incorporated in the work but delivered and suitably stored at the site (or at some location agreed upon in writing) to which the contractor has title or to which a subcontractor has title and has authorized the contractor to transfer title to the awarding authority, less (1) a retention based on its estimate of the fair value of its claims against the contractor and less (2) a retention for direct payments to subcontractors based on demands for same in accordance with the provisions of section thirty-nine F, and less (3) a retention not exceeding five percent of the approved amount of the periodic payment. After the receipt of a periodic estimate requesting final payment and within sixty-five-days after (a) the contractor fully completes the work or substantially completes the work so that the value of the work remaining to be done is, in the estimate of the awarding authority, less than one percent of the original contract price, or (b) the contractor substantially completes the work and the awarding authority takes possession for occupancy, whichever occurs first, the awarding authority shall pay the contractor the entire balance due on the contract less, (1) a retention based on its estimate of the fair value of its claims against the contractor and of the cost of completing the incomplete and unsatisfactory items of work less (2) a retention for direct payments to subcontractors based on demand for same in accordance with the provisions of section thirty-nine F, or based on the record of payments by the contractor to the subcontractors under this contract if such record of payment indicates that the contractor has not paid subcontractors as provided in section thirty-nine F. If the awarding authority fails to make payment as herein provided, there shall be added to each such payment daily interest at the rate of three percentage points above the rediscount rate then charged by the Federal Reserve Bank of Boston commencing on the first-day after said payment is due and continuing until the payment is delivered or mailed to the contractor; provided,

that no interest shall be due, in any event, on the amount due on a periodic estimate for final payment until fifteen-days (twenty-four-days in the case of the commonwealth) after receipt of such a periodic estimate from the contractor, at the place designated by the awarding authority if such a place is so designated. The contractor agrees to pay to each subcontractor a portion of any such interest paid in accordance with the amount due each subcontractor.

"The awarding authority may make changes in any periodic estimate submitted by the contractor and the payment due on said periodic estimate shall be computed in accordance with the changes so made, but such changes or any requirement for a corrected periodic estimate shall not affect the due date for the periodic payment or the date for the commencement of interest charges on the amount of the periodic payment computed in accordance with the changes made, as provided herein; provided, that the awarding authority may, within seven-days after receipt, return to the contractor for correction, any periodic estimate which is not in the required form or which contains computations not arithmetically corrected and, in that event, the date of receipt of such periodic estimate shall be the date of receipt of the corrected periodic estimate in proper form with arithmetically correct computations. The date of receipt of a periodic estimate received on a Saturday shall be the first working day thereafter. The provisions of section thirty-nine G shall not apply to any contract for the construction, reconstruction, alteration, remodeling, repair or demolition of any public building to which this section applies.

"All periodic estimates shall be submitted to the awarding authority, or to its designee as set forth in writing to the contractor, and the date of receipt by the awarding authority or its designee shall be marked on the estimate. All periodic estimates shall contain a separate item for each filed subtrade and each subtrade listed in sub-bid form as required by specifications and a column listing the amount paid to each filed subcontractor and Sub-subcontractor as of the date the periodic estimate is filed. The person making payment for the awarding authority shall add the daily interest provided for herein to each payment for each day beyond the due date based on the date of receipt marked on the estimate.

"A certificate of the architect to the effect that the contractor has fully or substantially completed the work shall, subject to the provisions of section thirty-nine J, be conclusive for the purposes of this section."

Section 39L. "Public Construction work by foreign corporations; restrictions and reports." The Commonwealth and every county, city, town, district, board, commission or other public body which, as the awarding authority, request proposals, bids or sub-bids for any work in the construction, reconstruction, alteration, remodeling, repair or demolition of any public building or other public works (1) shall not enter into a contract for such work with, and shall not approve as a subcontractor furnishing labor and materials for a part of any such work, a foreign corporation which has not filed with such awarding authority a certificate of the state secretary stating that such corporation has complied with sections three and five of chapter one hundred and eighty-one and the date

of such compliance, and (2) shall report to the state secretary and to the department of corporations and taxation any foreign corporation performing work under such contract or subcontract, and any person, other than a corporation, performing work under such contract or subcontract, and residing or having a principal place of business outside the commonwealth.

Section 39M(b). "Specifications for such contracts, and specifications for contracts awarded pursuant to the provisions of said sections forty-four A to forty-four L of said chapter one hundred and forty-nine, shall be written to provide for full competition for each item of material to be furnished under the contract; except, however, that said specifications may be otherwise written for sound reasons in the public interest stated in writing in the public records of the awarding authority or promptly given in writing by the awarding authority to anyone making a written request therefor, in either instance such writing to be prepared after reasonable investigation. Every such contract shall provide that an item equal to that named or described in the said specifications may be furnished; and an item shall be considered equal to the item so named or described if (1) it is at least equal in quality, durability, appearance, strength and design, (2) it will perform at least equally the function imposed by the general design for or the public work being contracted for or the material being purchased, and (3) it conforms substantially, even with deviations, to the detailed requirements for the item in the said specifications.

"For each item of material the specifications shall provide for either a minimum of three named brands of material or a description of material which can be met by a minimum of three manufacturers or producers, and for the equal of any one of said named or described materials."

Section 39N. "Every contract subject to section forty-four A of Chapter one hundred and forty-nine or subject to section thirty-nine M of chapter thirty shall contain the following paragraph in its entirety and an awarding authority may adopt reasonable rules or regulations in conformity with that paragraph concerning the filing, investigation and settlement of such claims:

"If, during the progress of the work, the contractor or the awarding authority discovers that the actual subsurface or latent physical conditions encountered at the site differ substantially or materially from those shown on the plans or indicated in the contract documents either the contractor or the contracting authority may request an equitable adjustment in the contract price of the contract applying to work affected by the differing site conditions. A request for such an adjustment shall be in writing and shall be delivered by the party making such claim to the other party as soon as possible after such conditions are discovered. Upon receipt of such a claim from a contractor, or upon its own initiative, the contracting authority shall make an investigation of such physical conditions, and, if they differ substantially or materially from those shown on the plans or indicated in the contract documents or from those ordinarily encountered and generally recognized as inherent in work of the character provided for in the plans and contract documents and are of such a nature as to cause an increase or decrease in the cost of performance of the work or a change in the construction methods required for the

performance of the work which results in an increase or decrease in the cost of the work, the contracting authority shall make an equitable adjustment in the contract price and the contract shall be modified in writing accordingly."

Section 39O. "Every contract subject to the provisions of section thirty-nine M of this chapter or subject to section forty-four A of chapter one hundred forty-nine shall contain the following provisions (a) and (b) in their entirety....

"(a) The awarding authority may order the general contractor in writing to suspend, delay, or interrupt all or any part of the work for such period of time as it may determine to be appropriate for the convenience of the awarding authority; provided however, that if there is a suspension, delay or interruption for fifteen-days or more due to a failure of the awarding authority to act within the time specified in this contract, the awarding authority shall make an adjustment in the contract price for any increase in the cost of performance of this contract but shall not include any profit to the general contractor on such increase; and provided further, that the awarding authority shall not make any adjustment in the contract price under this provision for any suspension, delay, interruption or failure to act to the extent that such is due to any cause for which this contract provides for an equitable adjustment of the contract price under any other contract provisions.

"(b) The general contractor must submit the amount of a claim under provision (a) to the awarding authority in writing as soon as practicable after the end of the suspension, delay, interruption or failure to act and, in any event, not later than the date of final payment under this contract and, except for costs due to a suspension order, the awarding authority shall not approve any costs in the claim incurred more than twenty-days before the general contractor notified the awarding authority in writing of the act or failure to act involved in the claim.

Section 39P. "Every contract subject to section thirty-nine M of this chapter or section forty-four A of chapter one hundred forty-nine which requires the awarding authority, or any official, its architect or engineer to make a decision on interpretation of the specifications, approval of equipment, material or any other approval, or progress of the work, shall require that the decision be made promptly and, in any event, no later than thirty-days after the written submission for decision; but if such decision requires extended investigation and study, the awarding authority, the official, architect or engineer shall, within thirty-days after the receipt of the submission, give the party making the submission written notice of the reasons why the decision cannot be made within the thirty-day period and the date by which the decision will be made."

Section 39R(a). "The words defined herein shall have the meaning stated below whenever they appear in this section:

- (1) "Contractor" means any person, corporation, partnership, joint venture, sole proprietorship, or other entity awarded a contract pursuant to section thirty-nine M of chapter thirty, sections forty-four A through H, inclusive, of chapter one hundred and forty-nine and sections thirty B through thirty P, inclusive, of chapter seven.
- (2) "Contract" means any contract awarded or executed pursuant to sections thirty B through thirty P, inclusive, of chapter seven and any contract awarded or executed pursuant to section thirty-nine M of chapter thirty, or sections forty-four A through H, inclusive, of chapter one hundred and forty-nine, which is for an amount or estimated amount greater than one hundred thousand dollars.
- (3) "Records" means books of original entry, accounts, checks, bank statements and all other banking documents, correspondence, memoranda, invoices, computer printouts, tapes, discs, papers and other documents or transcribed information of any type, whether expressed in ordinary or machine language.
- (4) "Independent Certified Public Accountant" means a person duly registered in good standing and entitled to practice as a certified public accountant under the laws of the place of his/her residence or principal office and who is in fact independent. In determining whether an accountant is independent with respect to a particular person, appropriate consideration should be given to all relationships between the accountant and that person or any affiliate thereof. Determination of an accountant's independence shall not be confined to the relationships existing in connection with the filing of reports with the awarding authority.
- (5) "Audit," when used in regard to financial statements, means an examination of records by an independent certified public accountant in accordance with generally accepted accounting principles and auditing standards for the purpose of expressing a certified opinion thereon, or, in the alternative, a qualified opinion or a declination to express an opinion for stated reasons.
- (6) "Accountant's Report," when used in regard to financial statements, means a document in which an independent certified public accountant indicates the scope of the audit which he/she has made and sets forth his/her opinion regarding the financial statements taken as a whole with a listing of noted exceptions and qualifications, or an assertion to the effect that an overall opinion cannot be expressed. When an overall opinion cannot be expressed the reason therefor shall be stated. An accountant's report shall include as a part thereof a signed statement by the responsible corporate officer attesting that management has fully disclosed all material facts to the independent certified public accountant, and that the audited financial

statement is a true and complete statement of the financial condition of the contractor.

- (7) "Management," when used herein, means the chief executive officer, partners, principals or other person or persons primarily responsible for the financial and operational policies and practices of the contractor.
- (8) Accounting terms, unless otherwise defined herein, shall have a meaning in accordance with generally accepted accounting principles and auditing standards.
 - (b) Subsection (a)(2) hereof notwithstanding, every agreement or contract awarded or executed pursuant to sections thirty B through thirty P, inclusive, of chapter seven, and pursuant to section thirty-nine M of chapter thirty or to section forth-five A through H, inclusive, of chapter one hundred and forty-nine, shall provide that:
 - (1) The contractor shall make, and keep for at least six years after final payment, books, records, and accounts which in reasonable detail accurately and fairly reflect the transactions and dispositions of the contractor, and
 - (2) Until the expiration of six years after final payment, the awarding authority, office of inspector general, and the deputy commissioner of capital planning and operations shall have the right to examine any books, documents, papers or records of the contractor or of his/her subcontractors that directly pertain to, and involve transactions relating to, the contractor or his/her subcontractors, and
 - (3) If the agreement is a contract as defined herein, the contractor shall describe any change in the method of maintaining records or recording transactions which materially affect any statements filed with the awarding authority, including in his/her description the date of the change and reasons therefor, and shall accompany said descriptions with a letter from the contractor's independent certified public accountant approving or otherwise commenting on the changes, and
 - (4) If the agreement is a contract as defined herein, the contractor has filed a statement of management on internal accounting controls as set forth in paragraph (c) below prior to the execution of the contract, and
 - (5) If the agreement is a contract as defined herein, the contractor has field prior to the execution of the contracts and will continue to file annually, an audited financial statement for the most recent completed fiscal year as set forth in paragraph (d) below.

(c) Every contractor awarded a contract shall file with the awarding authority a statement of management as to whether the system of internal accounting controls of the contractor and subsidiaries reasonably assures that:

- (1) Transactions are executed in accordance with management's general and specific authorization;
- (2) Transactions are recorded as necessary:
 - i. To permit preparation of financial statements in conformity with generally accepted accounting principles, and
 - ii. To maintain accountability for assets;
- (3) Access to assets is permitted only in accordance with management's general or specific authorization; and
- (4) The recorded accountability for assets is compared with the existing assets at reasonable intervals and appropriate action was taken with respect to any difference.

Every contractor awarded a contract shall also file with the awarding authority a statement prepared and signed by an independent certified public accountant, stating that he/she has examined the statement of management on internal accounting controls, and expressing an opinion as to:

- (1) Whether the representations of management in response to this paragraph, and paragraph (b) above are consistent with the result of management's evaluation of the system of internal accounting controls; and
 - (2) Whether such representations of management are, in addition, reasonable with respect to transactions and assets in amounts which would be material when measured in relation to the applicant's financial statements.
- (d) Every contractor awarded a contract by the commonwealth or by any political subdivision thereof shall annually file with the awarding authority and the deputy commissioner of capital planning and operations during the term of the contract a financial statement prepared by an independent certified public accountant on the basis of an audit by such accountant. The final statement filed shall include the date of final payment. All statements shall be accompanied by an accountant's report. Such statements shall be made available to the awarding authority upon request.

- (e) The office of inspector general, the deputy commissioner for capital planning and operations and any other awarding authority shall enforce the provisions of this section. The deputy commissioner of capital planning and operations may after providing an opportunity for the inspector general and other interested parties to comment, promulgate pursuant to the provisions of chapter thirty A such rules, regulations and guidelines as are necessary to effectuate the purposes of this section. Such rules, regulations and guidelines may be applicable to all awarding authorities. A contractor's failure to satisfy any of the requirements of this section may be grounds for debarment pursuant to section forty-four C of chapter one hundred and forty-nine."
- (f) Records and statements required to be made, kept or filed under the provisions of this section shall not be public records as defined in section seven of chapter four and shall not be open to public inspection; provided, however, that such records and statements shall be made available pursuant to the provisions of clause (2) of paragraph (b).

Section 40. "Bonds give to the commonwealth, any county, city, town or political subdivision to secure the performance of contracts for the construction or repair of public buildings or other public works may be discharged or released by the awarding authority, upon such terms as it deems expedient, after the expiration of one year from the time of completion, subject to section thirty-nine K, of the work contracted to be done; provided that no claim filed under said bond is pending, and provided further, that no such bonds shall be discharged or released prior to the expiration of all special guarantees provided for in the contract unless new bonds in substitution therefor specifically relating to the unexpired guarantees shall be taken.

EQUAL EMPLOYMENT OPPORTUNITIES

The Contractor and each Subcontractor shall comply with the provisions of the Governor's "Executive Order No. 74", dated July 20, 1970, entitled the "Governor's Code of Fair Practices", as amended by the Governor's "Executive Order No. 116", dated May 1, 1975; with the Fair Employment Practices Law of Massachusetts, as amended; with the Rules and Regulations of the Massachusetts Commission Against Discrimination, as in force at the date hereof; and with all other applicable municipal, state and federal laws and regulation regarding equal employment opportunity.

SECTION 00890

PERMITS

1. General Requirements

The Contractor shall perform the work in accordance with the Contract Documents, and any applicable municipal requirements.

2. Water Use Permit

The Contractor is required to secure a permit and hydrant meter from the Dedham-Westwood Water District (50 Elm Street, Dedham, Massachusetts 02027, phone number 781-329-7090) for the use of water. The Contractor is responsible for all costs associated with the water including, but not limited to permits, deposits and water used.

3. MWRA One-Time-Only Discharge Request Permit (CIPP)

The contractor is required to complete and submit the associated permit.

4. MWRA Root Control Request Permit

The contractor is required to complete and submit the permit to the Owner for submission to the MWRA

END OF SECTION



**MASSACHUSETTS WATER RESOURCES AUTHORITY
TOXIC REDUCTION AND CONTROL
2 GRIFFIN WAY
CHELSEA, MASSACHUSETTS 02150-3334**

**One-Time-Only Discharge Request
To discharge from a Cured-in-Place Pipe (CIPP) Lining process as part of a
sewer rehabilitation project into the Municipality or Authority sewerage
system**

Please, allow three weeks for processing this request

Name of Municipality: _____

Project Name: _____

Name of the person from the Municipality to contact concerning the information provided herein. *(Please, sign the signature page of this questionnaire, without a signature from the Municipality the MWRA will not be able to process this request.)*

Name: _____

Title: _____

Address: _____

Telephone No.: _____ Facsimile No.: _____

E Mail: _____

Contractor designated by the Municipality to conduct the project.

Name: _____

Title: _____

Company: _____

Address: _____

Telephone No.: _____ Facsimile No.: _____

E Mail: _____

MWRA Permit Number: _____

Person designated by the Municipality to receive correspondence from the MWRA regarding this project.

Name: _____

Title: _____

Company: _____

Address: _____

Telephone No.: _____ Facsimile No.: _____

GENERAL INFORMATION:

Please answer all of the questions

(If more space is needed, attach additional pages).

a) Cured-in-Place Pipe (CIPP)Liner is defined as a woven or non-woven or combination of woven and non-woven material surrounded or impregnated with resin which when installed and processed, forms to the shape and size of the interior walls of the host conduit as defined in ASTM Standard F1216.

b) Host Conduit is defined as the existing pipeline to be rehabilitated by CIPP Lining. The host conduit for this project must be indicated on the Contract Drawings.

1. Indicate the project scope. Provide pipe location and pipe length and diameter of each pipe to be treated. Use a pipe identification naming scheme that references the drawings and that will be recognizable by all parties. Identify all of the connection (using the name provide in Attachment A of the MWRA Municipal Discharge Permit) of the receiving MWRA interceptor and submit a diagram and drawing that will trace the flow from the project pipe to the MWRA interceptor.

Project scope and location: _____

Pipe Location Sewer Connection of the receiving MWRA interceptor <i>(Provide name in Attachment A of the MWRA Municipal Discharge Permit)</i>	Pipe Length (Feet)	Pipe Diameter (Inches)
_____ _____	_____ _____	_____ _____
_____ _____	_____ _____	_____ _____
_____ _____	_____ _____	_____ _____
_____ _____	_____ _____	_____ _____
_____ _____	_____ _____	_____ _____

2. Indicate how you will conduct the pipe cleaning process prior to the lining process.

3. Indicate the proposed installation method that you will employ for the CIPP liner into the existing pipe.

4. Indicate all of the appropriate Federal, state, and local permits and approvals obtained for this CIPP project.

5. Submit the Materials Safety Data Sheet(s) for the CIPP lining materials.

6. Indicate all source(s) of wastewater curing\lining process wastewater, cooling water, rinse water, pre-clean water, post-clean water, and, etc to be discharged into MWRA sewer system from this project.

Wastewater Type(s)	Source(s)
Curing water	<hr/> <hr/>
Cooling water	<hr/> <hr/>
Rinsing water	<hr/> <hr/>
Pre-cleaning water	<hr/> <hr/>
Post-cleaning water	<hr/> <hr/>
Other (Describe) <hr/> <hr/>	<hr/> <hr/>
Other (Describe) <hr/> <hr/>	<hr/> <hr/>

7. Describe the proposed pretreatment for the wastewater curing\lining process wastewater, cooling water, rinse water, pre-clean water, post-clean water, and, etc and provide equipment/flow diagram(s).

8. Indicate the storage method for treated and/or untreated curing\lining process wastewater, cooling water, rinse water, pre-clean water, post-clean water, etc, and provide its capacity in gallons prior to discharge into the MWRA sanitary sewer system.

Wastewater Type(s)	Storage method prior to discharge into MWRA sanitary sewer system.	Storage capacity (gallons)
Curing\lining process water		
Cooling water		
Rinsing water		
Pre-cleaning water		
Post-cleaning water		
Other (<i>Describe</i>) _____ _____		

9. Indicate proposed volume of wastewater (curing\lining process wastewater, cooling water, rinse water, pre-clean water, post-clean water, and, etc..) flow into the MWRA sewer system per day gallons per day (GPD).

Wastewater Type(s)	Volume(GPD) Discharge into MWRA sanitary sewer system	Pretreatment Yes/No	Pretreatment Type(s)
Curing\lining process water		Yes <input type="checkbox"/> No <input type="checkbox"/>	
Cooling water		Yes <input type="checkbox"/> No <input type="checkbox"/>	
Rinsing water		Yes <input type="checkbox"/> No <input type="checkbox"/>	
Pre-cleaning water		Yes <input type="checkbox"/> No <input type="checkbox"/>	
Post-cleaning water		Yes <input type="checkbox"/> No <input type="checkbox"/>	
Other (<i>Describe</i>) <hr/> <hr/>		Yes <input type="checkbox"/> No <input type="checkbox"/>	

10. Describe other method(s) for the collection and disposal for the curing\lining process wastewater, cooling water, and/or rinse water if pretreatment is not viable, and the discharge to the MWRA sanitary sewer system is not authorized.

11. Indicate if solids will be generated from the treatment process, including solidified styrene and other solid byproducts. All solids must be removed from the cure water and subsequent cooling and rinsing operations, prior to discharge into MWRA sewer system, pursuant 360 C.M.R. 10.023(8).

12. Indicate proposed date(s) of discharge into the MWRA sewer system.

Anticipated first day of discharge: _____

Anticipated last day of discharge: _____

Proposed hours of discharge into MWRA sewer system: _____

13. Provide the construction schedule for the project including specific proposed date(s) and start and end times. If specific dates are not known, please use Day 1 (one) for taking the pipe out of service and count forward from there. If individual operating time will take less than twenty-four hours, specify start and end times in military time.

Action(s)	Date (mm/dd/yyyy)	Operating Time (hrs:min:sec)	Comments(s)
Taking pipe out of service			
Pre-cleaning of pipe (Start)			
Pre-cleaning of pipe (End)			
Line installation (Start)			
Line installation (End)			
Curing process (Start)			
Curing process (End)			
Cooling process (Start)			
Cooling process (End)			
Rinsing (Start)			
Rinsing (End)			
Return pipe to service			
Other (Describe)			

14. Indicate how you will ensure that sufficient capacity (gallons) at the construction zone in the event of a storm event. Describe how flow through the pipe will be diverted around the construction zone and provide rerouting plans, and pipe blockage techniques that you will employ. Specify materials that will be used and storage measures that will be employed.

15. CERTIFICATION STATEMENT AND SIGNATURE:

The questionnaire for a One-Time-Only Discharge Request must be signed and dated by an authorized representative. If an authorization is no longer accurate because a different individual or position has responsibility for the overall operation of the sewer system, a new authorization satisfying the requirements of this section must be submitted to the MWRA prior to or together with any reports to be signed by an authorized representative.

An authorized representative of a municipality includes:

- a) a responsible public official, including a Mayor, City Manager, Town Administrator, Chair of the Board of Selectman, District Manager, or any other person who performs similar policy or decision-making functions for the municipality, or the director, manager, or superintendent of the department responsible for operating or overseeing the operation of the sewer system, if authority to sign documents has been assigned or delegated to the individual in accordance with the municipality's procedures.
- b) the duly authorized representative of the individual designated in (a) of this section if:
 - i) the authorization is made in writing by the individual described in (a);
 - ii) the authorization specifies either an individual or a position having responsibility for the overall operation of the sewer system from which the discharge originates, such as the position of superintendent, or a position of equivalent responsibility, or having overall responsibility for environmental matters for the municipality;
 - iii) the written authorization is submitted to the MWRA.

I certify under penalty of law that this document and all attachments were prepared under my direction or supervision in accordance with a system designed to assure that qualified personnel properly gather and evaluate the information submitted. Based on my inquiry of the person or persons who manage the sewer system, or those persons directly responsible for gathering the information, the information submitted is, to the best of my knowledge and belief, true, accurate, and complete. I am aware that there are significant penalties for submitting false information, including the possibility of fine and imprisonment for knowing violations.

Signature of Authorized Representative

Please Print Name of Authorized Representative

Title

Date

PLEASE, ALLOW THREE WEEKS FOR PROCESSING THIS REQUEST
Do not alter this form

To discharge wastewater from a sewer pipe lining/curing project into the Authority sewer system. Submit the completed form to:

Massachusetts Water Resources Authority
Toxic Reduction and Control
2 Griffin Way, Chelsea MA 02150-3334
Attention: Kattia Thomas, Project Manager, Permitting

If you have any questions regarding the approval process, you may contact Kattia Thomas, at 617-305-5667.



**MASSACHUSETTS WATER RESOURCES AUTHORITY
TOXIC REDUCTION AND CONTROL
2 GRIFFIN WAY
CHELSEA, MASSACHUSETTS 02150-3334**

PLEASE, ALLOW
THREE WEEKS FOR
PROCESSING THIS
REQUEST

**Request To Conduct
A Root Control Project**

Name of Municipality: _____

Name of the person from the Municipality to contact concerning the information provided herein. *(Please, sign page 2 of this questionnaire, without a signature from the municipality the MWRA will not be able to process this request.)*

Name: _____

Title: _____

Address: _____

Telephone No.: _____ Facsimile No.: _____

Person designated by the Municipality to receive correspondence from the MWRA regarding this project.

Name: _____

Title: _____

Address: _____

Telephone No.: _____ Facsimile No.: _____

1. Provide a description of the project.

2. Indicate the location and length (linear feet) of pipe to be treated?
Provide street name(s) and provide a map if applicable.

Page 2

3. Indicate the name of the active ingredient that will be used each day.
Provide the MSDS(s) for the chemical(s) that will be used.

4. Indicate the name and volume (gallons) of the solvent or water and the active ingredient to be used each day.

Solvent Name (provide the name)

Volume (gallons/day)

Active Ingredient Name

Volume (gallons/day)

5. The total pounds of solution (the active ingredient) to be used each day?

6. The total pounds of solution (the active ingredient) to be used for the entire project?

7. The total number of days the pipes will be treated?

Anticipated first day of the project: _____

Anticipated last day of the project: _____

8. The time of day for the treatment?

9. The amount of time (hours) the active ingredient will remain in the sewer pipe after the treatment process?

Signature (*Municipality*)

Date

FAX this page to Kattia Thomas, Proj. Mgr, Permitting, TRAC, the fax number is 617-371-1604.

PLEASE, ALLOW THREE WEEKS FOR PROCESSING THIS REQUEST

ATTACHMENT A - WAGE RATES AND CERTIFICATE OF COMPLIANCE



CHARLES D. BAKER
Governor

KARYN E. POLITO
Lt. Governor

THE COMMONWEALTH OF MASSACHUSETTS
EXECUTIVE OFFICE OF LABOR AND WORKFORCE DEVELOPMENT
DEPARTMENT OF LABOR STANDARDS

Prevailing Wage Rates

As determined by the Director under the provisions of the
Massachusetts General Laws, Chapter 149, Sections 26 to 27H

ROSALIN ACOSTA
Secretary
MICHAEL FLANAGAN
Director

Awarding Authority: Town of Dedham
Contract Number: **City/Town:** DEDHAM
Description of Work: 2021 Sewer On-Call Services - Including but not limited to Emergency Cleaning, Cleaning & TV work orders, Wet weather inspections, Long and Short CIPP, MH Rehab, Root treatment.
Job Location: Various Locations

Information about Prevailing Wage Schedules for Awarding Authorities and Contractors

- This wage schedule applies only to the specific project referenced at the top of this page and uniquely identified by the “Wage Request Number” on all pages of this schedule.
 - An Awarding Authority must request an updated wage schedule from the Department of Labor Standards (“DLS”) if it has not opened bids or selected a contractor within 90 days of the date of issuance of the wage schedule. For CM AT RISK projects (bid pursuant to G.L. c.149A), the earlier of: (a) the execution date of the GMP Amendment, or (b) the bid for the first construction scope of work must be within 90-days of the wage schedule issuance date.
 - The wage schedule shall be incorporated in any advertisement or call for bids for the project as required by M.G.L. c. 149, § 27. The wage schedule shall be made a part of the contract awarded for the project. The wage schedule must be posted in a conspicuous place at the work site for the life of the project in accordance with M.G.L. c. 149 § 27. The wages listed on the wage schedule must be paid to employees performing construction work on the project whether they are employed by the prime contractor, a filed sub-bidder, or any sub-contractor.
 - All apprentices working on the project are required to be registered with the Massachusetts Department of Labor Standards, Division of Apprentice Standards (DLS/DAS). Apprentice must keep his/her apprentice identification card on his/her person during all work hours on the project. An apprentice registered with DAS may be paid the lower apprentice wage rate at the applicable step as provided on the prevailing wage schedule. **Any apprentice not registered with DLS/DAS regardless of whether or not they are registered with any other federal, state, local, or private agency must be paid the journeyworker's rate for the trade.**
 - The wage rates will remain in effect for the duration of the project, except in the case of multi-year public construction projects. For construction projects lasting longer than one year, awarding authorities must request an updated wage schedule. Awarding authorities are required to request these updates no later than two weeks before the anniversary of the date the contract was executed by the awarding authority and the general contractor. For multi-year CM AT RISK projects, awarding authority must request an annual update no later than two weeks before the anniversary date, determined as the earlier of: (a) the execution date of the GMP Amendment, or (b) the execution date of the first amendment to permit procurement of construction services. Contractors are required to obtain the wage schedules from awarding authorities, and to pay no less than these rates to covered workers. The annual update requirement is not applicable to 27F “rental of equipment” contracts.
 - Every contractor or subcontractor which performs construction work on the project is required to submit weekly payroll reports and a Statement of Compliance directly to the awarding authority by mail or email and keep them on file for three years. Each weekly payroll report must contain: the employee’s name, address, occupational classification, hours worked, and wages paid. Do not submit weekly payroll reports to DLS. A sample of a payroll reporting form may be obtained at <http://www.mass.gov/dols/pw>.
 - Contractors with questions about the wage rates or classifications included on the wage schedule have an affirmative obligation to inquire with DLS at (617) 626-6953.
 - Employees not receiving the prevailing wage rate set forth on the wage schedule may report the violation to the Fair Labor Division of the office of the Attorney General at (617) 727-3465.
 - Failure of a contractor or subcontractor to pay the prevailing wage rates listed on the wage schedule to all employees who perform construction work on the project is a violation of the law and subjects the contractor or subcontractor to civil and criminal penalties.
-

Classification	Effective Date	Base Wage	Health	Pension	Supplemental Unemployment	Total Rate
Construction						
(2 AXLE) DRIVER - EQUIPMENT <i>TEAMSTERS JOINT COUNCIL NO. 10 ZONE A</i>	12/01/2020	\$36.25	\$12.91	\$14.82	\$0.00	\$63.98
	06/01/2021	\$37.05	\$12.91	\$14.82	\$0.00	\$64.78
	08/01/2021	\$37.05	\$13.41	\$14.82	\$0.00	\$65.28
	12/01/2021	\$37.05	\$13.41	\$16.01	\$0.00	\$66.47
(3 AXLE) DRIVER - EQUIPMENT <i>TEAMSTERS JOINT COUNCIL NO. 10 ZONE A</i>	12/01/2020	\$36.32	\$12.91	\$14.82	\$0.00	\$64.05
	06/01/2021	\$37.12	\$12.91	\$14.82	\$0.00	\$64.85
	08/01/2021	\$37.12	\$13.41	\$14.82	\$0.00	\$65.35
	12/01/2021	\$37.12	\$13.41	\$16.01	\$0.00	\$66.54
(4 & 5 AXLE) DRIVER - EQUIPMENT <i>TEAMSTERS JOINT COUNCIL NO. 10 ZONE A</i>	12/01/2020	\$36.44	\$12.91	\$14.82	\$0.00	\$64.17
	06/01/2021	\$37.24	\$12.91	\$14.82	\$0.00	\$64.97
	08/01/2021	\$37.24	\$13.41	\$14.82	\$0.00	\$65.47
	12/01/2021	\$37.24	\$13.41	\$16.01	\$0.00	\$66.66
ADS/SUBMERSIBLE PILOT <i>PILE DRIVER LOCAL 56 (ZONE 1)</i>	08/01/2020	\$103.05	\$9.40	\$23.12	\$0.00	\$135.57
For apprentice rates see "Apprentice- PILE DRIVER"						
AIR TRACK OPERATOR <i>LABORERS - ZONE 1</i>	12/01/2020	\$40.65	\$8.60	\$17.32	\$0.00	\$66.57
	06/01/2021	\$41.67	\$8.60	\$17.32	\$0.00	\$67.59
	12/01/2021	\$42.68	\$8.60	\$17.32	\$0.00	\$68.60
	06/01/2022	\$43.68	\$8.60	\$17.32	\$0.00	\$69.60
	12/01/2022	\$44.68	\$8.60	\$17.32	\$0.00	\$70.60
	06/01/2023	\$45.68	\$8.60	\$17.32	\$0.00	\$71.60
	12/01/2023	\$46.93	\$8.60	\$17.32	\$0.00	\$72.85
For apprentice rates see "Apprentice- LABORER"						
AIR TRACK OPERATOR (HEAVY & HIGHWAY) <i>LABORERS - ZONE 1 (HEAVY & HIGHWAY)</i>	12/01/2020	\$40.65	\$8.60	\$17.32	\$0.00	\$66.57
	06/01/2021	\$41.67	\$8.60	\$17.32	\$0.00	\$67.59
	12/01/2021	\$42.68	\$8.60	\$17.32	\$0.00	\$68.60
For apprentice rates see "Apprentice- LABORER (Heavy and Highway)"						
ASBESTOS REMOVER - PIPE / MECH. EQUIPT. <i>HEAT & FROST INSULATORS LOCAL 6 (BOSTON)</i>	12/01/2020	\$38.10	\$12.80	\$9.45	\$0.00	\$60.35
ASPHALT RAKER <i>LABORERS - ZONE 1</i>	12/01/2020	\$40.15	\$8.60	\$17.32	\$0.00	\$66.07
	06/01/2021	\$41.17	\$8.60	\$17.32	\$0.00	\$67.09
	12/01/2021	\$42.18	\$8.60	\$17.32	\$0.00	\$68.10
	06/01/2022	\$43.18	\$8.60	\$17.32	\$0.00	\$69.10
	12/01/2022	\$44.18	\$8.60	\$17.32	\$0.00	\$70.10
	06/01/2023	\$45.18	\$8.60	\$17.32	\$0.00	\$71.10
	12/01/2023	\$46.43	\$8.60	\$17.32	\$0.00	\$72.35
For apprentice rates see "Apprentice- LABORER"						
ASPHALT RAKER (HEAVY & HIGHWAY) <i>LABORERS - ZONE 1 (HEAVY & HIGHWAY)</i>	12/01/2020	\$40.15	\$8.60	\$17.32	\$0.00	\$66.07
	06/01/2021	\$41.17	\$8.60	\$17.32	\$0.00	\$67.09
	12/01/2021	\$42.18	\$8.60	\$17.32	\$0.00	\$68.10
For apprentice rates see "Apprentice- LABORER (Heavy and Highway)"						
ASPHALT/CONCRETE/CRUSHER PLANT-ON SITE <i>OPERATING ENGINEERS LOCAL 4</i>	12/01/2020	\$49.98	\$13.50	\$15.70	\$0.00	\$79.18
	06/01/2021	\$51.08	\$13.50	\$15.70	\$0.00	\$80.28
	12/01/2021	\$52.23	\$13.50	\$15.70	\$0.00	\$81.43
For apprentice rates see "Apprentice- OPERATING ENGINEERS"						

Classification	Effective Date	Base Wage	Health	Pension	Supplemental Unemployment	Total Rate
BACKHOE/FRONT-END LOADER <i>OPERATING ENGINEERS LOCAL 4</i>	12/01/2020	\$49.98	\$13.50	\$15.70	\$0.00	\$79.18
	06/01/2021	\$51.08	\$13.50	\$15.70	\$0.00	\$80.28
	12/01/2021	\$52.23	\$13.50	\$15.70	\$0.00	\$81.43
For apprentice rates see "Apprentice- OPERATING ENGINEERS"						
BARCO-TYPE JUMPING TAMPER <i>LABORERS - ZONE 1</i>	12/01/2020	\$40.15	\$8.60	\$17.32	\$0.00	\$66.07
	06/01/2021	\$41.17	\$8.60	\$17.32	\$0.00	\$67.09
	12/01/2021	\$42.18	\$8.60	\$17.32	\$0.00	\$68.10
	06/01/2022	\$43.18	\$8.60	\$17.32	\$0.00	\$69.10
	12/01/2022	\$44.18	\$8.60	\$17.32	\$0.00	\$70.10
	06/01/2023	\$45.18	\$8.60	\$17.32	\$0.00	\$71.10
	12/01/2023	\$46.43	\$8.60	\$17.32	\$0.00	\$72.35
For apprentice rates see "Apprentice- LABORER"						
BLOCK PAVER, RAMMER / CURB SETTER <i>LABORERS - ZONE 1</i>	12/01/2020	\$40.65	\$8.60	\$17.32	\$0.00	\$66.57
	06/01/2021	\$41.67	\$8.60	\$17.32	\$0.00	\$67.59
	12/01/2021	\$42.68	\$8.60	\$17.32	\$0.00	\$68.60
	06/01/2022	\$43.68	\$8.60	\$17.32	\$0.00	\$69.60
	12/01/2022	\$44.68	\$8.60	\$17.32	\$0.00	\$70.60
	06/01/2023	\$45.68	\$8.60	\$17.32	\$0.00	\$71.60
	12/01/2023	\$46.93	\$8.60	\$17.32	\$0.00	\$72.85
For apprentice rates see "Apprentice- LABORER"						
BLOCK PAVER, RAMMER / CURB SETTER (HEAVY & HIGHWAY) <i>LABORERS - ZONE 1 (HEAVY & HIGHWAY)</i>	12/01/2020	\$40.65	\$8.60	\$17.32	\$0.00	\$66.57
	06/01/2021	\$41.67	\$8.60	\$17.32	\$0.00	\$67.59
	12/01/2021	\$42.68	\$8.60	\$17.32	\$0.00	\$68.60
For apprentice rates see "Apprentice- LABORER (Heavy and Highway)"						
BOILER MAKER <i>BOILERMAKERS LOCAL 29</i>	01/01/2020	\$46.10	\$7.07	\$17.98	\$0.00	\$71.15

Apprentice - BOILERMAKER - Local 29

Effective Date - 01/01/2020

Step	percent	Apprentice Base Wage	Health	Pension	Supplemental Unemployment	Total Rate
1	65	\$29.97	\$7.07	\$11.69	\$0.00	\$48.73
2	65	\$29.97	\$7.07	\$11.69	\$0.00	\$48.73
3	70	\$32.27	\$7.07	\$12.59	\$0.00	\$51.93
4	75	\$34.58	\$7.07	\$13.49	\$0.00	\$55.14
5	80	\$36.88	\$7.07	\$14.38	\$0.00	\$58.33
6	85	\$39.19	\$7.07	\$15.29	\$0.00	\$61.55
7	90	\$41.49	\$7.07	\$16.18	\$0.00	\$64.74
8	95	\$43.80	\$7.07	\$17.09	\$0.00	\$67.96

Notes:

Apprentice to Journeyworker Ratio:1:4

Classification	Effective Date	Base Wage	Health	Pension	Supplemental Unemployment	Total Rate
BRICK/STONE/ARTIFICIAL MASONRY (INCL. MASONRY WATERPROOFING) <i>BRICKLAYERS LOCAL 3 (FOXBORO)</i>	08/01/2020	\$53.61	\$10.75	\$21.45	\$0.00	\$85.81
	02/01/2021	\$54.21	\$10.75	\$21.45	\$0.00	\$86.41
	08/01/2021	\$55.61	\$10.75	\$21.61	\$0.00	\$87.97
	02/01/2022	\$56.19	\$10.75	\$21.61	\$0.00	\$88.55

Apprentice - BRICK/PLASTER/CEMENT MASON - Local 3 Foxboro

Effective Date - 08/01/2020

Step	percent	Apprentice Base Wage	Health	Pension	Supplemental Unemployment	Total Rate
1	50	\$26.81	\$10.75	\$21.45	\$0.00	\$59.01
2	60	\$32.17	\$10.75	\$21.45	\$0.00	\$64.37
3	70	\$37.53	\$10.75	\$21.45	\$0.00	\$69.73
4	80	\$42.89	\$10.75	\$21.45	\$0.00	\$75.09
5	90	\$48.25	\$10.75	\$21.45	\$0.00	\$80.45

Effective Date - 02/01/2021

Step	percent	Apprentice Base Wage	Health	Pension	Supplemental Unemployment	Total Rate
1	50	\$27.11	\$10.75	\$21.45	\$0.00	\$59.31
2	60	\$32.53	\$10.75	\$21.45	\$0.00	\$64.73
3	70	\$37.95	\$10.75	\$21.45	\$0.00	\$70.15
4	80	\$43.37	\$10.75	\$21.45	\$0.00	\$75.57
5	90	\$48.79	\$10.75	\$21.45	\$0.00	\$80.99

Notes:

Apprentice to Journeyworker Ratio:1:5

BULLDOZER/GRADER/SCRAPER <i>OPERATING ENGINEERS LOCAL 4</i>	12/01/2020	\$49.45	\$13.50	\$15.70	\$0.00	\$78.65
	06/01/2021	\$50.54	\$13.50	\$15.70	\$0.00	\$79.74
	12/01/2021	\$51.68	\$13.50	\$15.70	\$0.00	\$80.88

For apprentice rates see "Apprentice- OPERATING ENGINEERS"

CAISSON & UNDERPINNING BOTTOM MAN <i>LABORERS - FOUNDATION AND MARINE</i>	12/01/2020	\$41.05	\$8.60	\$17.47	\$0.00	\$67.12
	06/01/2021	\$42.07	\$8.60	\$17.47	\$0.00	\$68.14
	12/01/2021	\$43.08	\$8.60	\$17.47	\$0.00	\$69.15

For apprentice rates see "Apprentice- LABORER"

CAISSON & UNDERPINNING LABORER <i>LABORERS - FOUNDATION AND MARINE</i>	12/01/2020	\$39.90	\$8.60	\$17.47	\$0.00	\$65.97
	06/01/2021	\$40.92	\$8.60	\$17.47	\$0.00	\$66.99
	12/01/2021	\$41.93	\$8.60	\$17.47	\$0.00	\$68.00

For apprentice rates see "Apprentice- LABORER"

CAISSON & UNDERPINNING TOP MAN <i>LABORERS - FOUNDATION AND MARINE</i>	12/01/2020	\$39.90	\$8.60	\$17.47	\$0.00	\$65.97
	06/01/2021	\$40.92	\$8.60	\$17.47	\$0.00	\$66.99
	12/01/2021	\$41.93	\$8.60	\$17.47	\$0.00	\$68.00

For apprentice rates see "Apprentice- LABORER"

Classification	Effective Date	Base Wage	Health	Pension	Supplemental Unemployment	Total Rate
CARBIDE CORE DRILL OPERATOR <i>LABORERS - ZONE 1</i>	12/01/2020	\$40.15	\$8.60	\$17.32	\$0.00	\$66.07
	06/01/2021	\$41.17	\$8.60	\$17.32	\$0.00	\$67.09
	12/01/2021	\$42.18	\$8.60	\$17.32	\$0.00	\$68.10
	06/01/2022	\$43.18	\$8.60	\$17.32	\$0.00	\$69.10
	12/01/2022	\$44.18	\$8.60	\$17.32	\$0.00	\$70.10
	06/01/2023	\$45.18	\$8.60	\$17.32	\$0.00	\$71.10
	12/01/2023	\$46.43	\$8.60	\$17.32	\$0.00	\$72.35

For apprentice rates see "Apprentice- LABORER"

CARPENTER <i>CARPENTERS -ZONE 1 (Metro Boston)</i>	09/01/2020	\$51.53	\$9.40	\$18.95	\$0.00	\$79.88
	03/01/2021	\$52.38	\$9.40	\$18.95	\$0.00	\$80.73
	09/01/2021	\$53.28	\$9.40	\$18.95	\$0.00	\$81.63
	03/01/2022	\$54.13	\$9.40	\$18.95	\$0.00	\$82.48
	09/01/2022	\$55.03	\$9.40	\$18.95	\$0.00	\$83.38
	03/01/2023	\$55.88	\$9.40	\$18.95	\$0.00	\$84.23

Apprentice - CARPENTER - Zone 1 Metro Boston

Effective Date - 09/01/2020

Step	percent	Apprentice Base Wage	Health	Pension	Supplemental Unemployment	Total Rate
1	50	\$25.77	\$9.40	\$1.73	\$0.00	\$36.90
2	60	\$30.92	\$9.40	\$1.73	\$0.00	\$42.05
3	70	\$36.07	\$9.40	\$13.76	\$0.00	\$59.23
4	75	\$38.65	\$9.40	\$13.76	\$0.00	\$61.81
5	80	\$41.22	\$9.40	\$15.49	\$0.00	\$66.11
6	80	\$41.22	\$9.40	\$15.49	\$0.00	\$66.11
7	90	\$46.38	\$9.40	\$17.22	\$0.00	\$73.00
8	90	\$46.38	\$9.40	\$17.22	\$0.00	\$73.00

Effective Date - 03/01/2021

Step	percent	Apprentice Base Wage	Health	Pension	Supplemental Unemployment	Total Rate
1	50	\$26.19	\$9.40	\$1.73	\$0.00	\$37.32
2	60	\$31.43	\$9.40	\$1.73	\$0.00	\$42.56
3	70	\$36.67	\$9.40	\$13.76	\$0.00	\$59.83
4	75	\$39.29	\$9.40	\$13.76	\$0.00	\$62.45
5	80	\$41.90	\$9.40	\$15.49	\$0.00	\$66.79
6	80	\$41.90	\$9.40	\$15.49	\$0.00	\$66.79
7	90	\$47.14	\$9.40	\$17.22	\$0.00	\$73.76
8	90	\$47.14	\$9.40	\$17.22	\$0.00	\$73.76

Notes:

% Indentured After 10/1/17; 45/45/55/55/70/70/80/80
Step 1&2 \$34.32/ 3&4 \$41.14/ 5&6 \$60.96/ 7&8 \$67.84

Apprentice to Journeyworker Ratio:1:5

CARPENTER WOOD FRAME <i>CARPENTERS -ZONE 2 (Wood Frame)</i>	04/01/2020	\$27.12	\$7.21	\$5.80	\$0.00	\$40.13
	04/01/2021	\$27.87	\$7.21	\$5.80	\$0.00	\$40.88
	04/01/2022	\$28.62	\$7.21	\$5.80	\$0.00	\$41.63
	04/01/2023	\$28.97	\$7.21	\$5.80	\$0.00	\$41.98

Classification

All Aspects of New Wood Frame Work

Effective Date Base Wage Health Pension Supplemental Unemployment Total Rate

Apprentice - CARPENTER (Wood Frame) - Zone 2

Effective Date - 04/01/2020

Step	percent	Apprentice Base Wage	Health	Pension	Supplemental Unemployment	Total Rate
1	60	\$16.27	\$7.21	\$0.00	\$0.00	\$23.48
2	60	\$16.27	\$7.21	\$0.00	\$0.00	\$23.48
3	65	\$17.63	\$7.21	\$2.00	\$0.00	\$26.84
4	70	\$18.98	\$7.21	\$2.00	\$0.00	\$28.19
5	75	\$20.34	\$7.21	\$5.80	\$0.00	\$33.35
6	80	\$21.70	\$7.21	\$5.80	\$0.00	\$34.71
7	85	\$23.05	\$7.21	\$5.80	\$0.00	\$36.06
8	90	\$24.41	\$7.21	\$5.80	\$0.00	\$37.42

Effective Date - 04/01/2021

Step	percent	Apprentice Base Wage	Health	Pension	Supplemental Unemployment	Total Rate
1	60	\$16.72	\$7.21	\$0.00	\$0.00	\$23.93
2	60	\$16.72	\$7.21	\$0.00	\$0.00	\$23.93
3	65	\$18.12	\$7.21	\$2.00	\$0.00	\$27.33
4	70	\$19.51	\$7.21	\$2.00	\$0.00	\$28.72
5	75	\$20.90	\$7.21	\$5.80	\$0.00	\$33.91
6	80	\$22.30	\$7.21	\$5.80	\$0.00	\$35.31
7	85	\$23.69	\$7.21	\$5.80	\$0.00	\$36.70
8	90	\$25.08	\$7.21	\$5.80	\$0.00	\$38.09

Notes:

% Indentured After 10/1/17; 45/45/55/55/70/70/80/80
 Step 1&2 \$19.41/ 3&4 \$24.13/ 5&6 \$31.99/ 7&8 \$34.71

Apprentice to Journeyworker Ratio:1:5

CEMENT MASONRY/PLASTERING BRICKLAYERS LOCAL 3 (FOXBORO)	01/01/2020	\$44.67	\$12.75	\$22.41	\$0.62	\$80.45
--	------------	---------	---------	---------	--------	---------

Classification

Effective Date Base Wage Health Pension Supplemental Unemployment Total Rate

Apprentice - CEMENT MASONRY/PLASTERING - Foxboro

Effective Date - 01/01/2020

Step	percent	Apprentice Base Wage	Health	Pension	Supplemental Unemployment	Total Rate
1	50	\$22.34	\$12.75	\$15.41	\$0.00	\$50.50
2	60	\$26.80	\$12.75	\$17.41	\$0.62	\$57.58
3	65	\$29.04	\$12.75	\$18.41	\$0.62	\$60.82
4	70	\$31.27	\$12.75	\$19.41	\$0.62	\$64.05
5	75	\$33.50	\$12.75	\$20.41	\$0.62	\$67.28
6	80	\$35.74	\$12.75	\$21.41	\$0.62	\$70.52
7	90	\$40.20	\$12.75	\$22.41	\$0.62	\$75.98

Notes:

Steps 3,4 are 500 hrs. All other steps are 1,000 hrs.

Apprentice to Journeyworker Ratio:1:3

CHAIN SAW OPERATOR <i>LABORERS - ZONE 1</i>	12/01/2020	\$40.15	\$8.60	\$17.32	\$0.00	\$66.07
	06/01/2021	\$41.17	\$8.60	\$17.32	\$0.00	\$67.09
	12/01/2021	\$42.18	\$8.60	\$17.32	\$0.00	\$68.10
	06/01/2022	\$43.18	\$8.60	\$17.32	\$0.00	\$69.10
	12/01/2022	\$44.18	\$8.60	\$17.32	\$0.00	\$70.10
	06/01/2023	\$45.18	\$8.60	\$17.32	\$0.00	\$71.10
	12/01/2023	\$46.43	\$8.60	\$17.32	\$0.00	\$72.35

For apprentice rates see "Apprentice- LABORER"

CLAM SHELLS/SLURRY BUCKETS/HEADING MACHINES <i>OPERATING ENGINEERS LOCAL 4</i>	12/01/2020	\$50.98	\$13.50	\$15.70	\$0.00	\$80.18
	06/01/2021	\$52.08	\$13.50	\$15.70	\$0.00	\$81.28
	12/01/2021	\$53.23	\$13.50	\$15.70	\$0.00	\$82.43

For apprentice rates see "Apprentice- OPERATING ENGINEERS"

COMPRESSOR OPERATOR <i>OPERATING ENGINEERS LOCAL 4</i>	12/01/2020	\$33.00	\$13.50	\$15.70	\$0.00	\$62.20
	06/01/2021	\$33.75	\$13.50	\$15.70	\$0.00	\$62.95
	12/01/2021	\$34.54	\$13.50	\$15.70	\$0.00	\$63.74

For apprentice rates see "Apprentice- OPERATING ENGINEERS"

DELEADER (BRIDGE) <i>PAINTERS LOCAL 35 - ZONE 1</i>	01/01/2021	\$52.06	\$8.25	\$22.75	\$0.00	\$83.06
---	------------	---------	--------	---------	--------	---------

Classification

Effective Date Base Wage Health Pension Supplemental Unemployment Total Rate

Apprentice - PAINTER Local 35 - BRIDGES/TANKS

Effective Date - 01/01/2021

Step	percent	Apprentice Base Wage	Health	Pension	Supplemental Unemployment	Total Rate
1	50	\$26.03	\$8.25	\$0.00	\$0.00	\$34.28
2	55	\$28.63	\$8.25	\$6.16	\$0.00	\$43.04
3	60	\$31.24	\$8.25	\$6.72	\$0.00	\$46.21
4	65	\$33.84	\$8.25	\$7.28	\$0.00	\$49.37
5	70	\$36.44	\$8.25	\$19.39	\$0.00	\$64.08
6	75	\$39.05	\$8.25	\$19.95	\$0.00	\$67.25
7	80	\$41.65	\$8.25	\$20.51	\$0.00	\$70.41
8	90	\$46.85	\$8.25	\$21.63	\$0.00	\$76.73

Notes:

Steps are 750 hrs.

Apprentice to Journeyworker Ratio:1:1

DEMO: ADZEMAN LABORERS - ZONE 1	12/01/2020	\$40.05	\$8.60	\$17.32	\$0.00	\$65.97
	06/01/2021	\$41.07	\$8.60	\$17.32	\$0.00	\$66.99
	12/01/2021	\$42.08	\$8.60	\$17.32	\$0.00	\$68.00
	06/01/2022	\$43.08	\$8.60	\$17.32	\$0.00	\$69.00
	12/01/2022	\$44.08	\$8.60	\$17.32	\$0.00	\$70.00
	06/01/2023	\$45.08	\$8.60	\$17.32	\$0.00	\$71.00
	12/01/2023	\$46.33	\$8.60	\$17.32	\$0.00	\$72.25

For apprentice rates see "Apprentice- LABORER"

DEMO: BACKHOE/LOADER/HAMMER OPERATOR LABORERS - ZONE 1	12/01/2020	\$41.05	\$8.60	\$17.32	\$0.00	\$66.97
	06/01/2021	\$42.07	\$8.60	\$17.32	\$0.00	\$67.99
	12/01/2021	\$43.08	\$8.60	\$17.32	\$0.00	\$69.00
	06/01/2022	\$44.08	\$8.60	\$17.32	\$0.00	\$70.00
	12/01/2022	\$45.08	\$8.60	\$17.32	\$0.00	\$71.00
	06/01/2023	\$46.08	\$8.60	\$17.32	\$0.00	\$72.00
	12/01/2023	\$47.33	\$8.60	\$17.32	\$0.00	\$73.25

For apprentice rates see "Apprentice- LABORER"

DEMO: BURNERS LABORERS - ZONE 1	12/01/2020	\$40.80	\$8.60	\$17.32	\$0.00	\$66.72
	06/01/2021	\$41.82	\$8.60	\$17.32	\$0.00	\$67.74
	12/01/2021	\$42.83	\$8.60	\$17.32	\$0.00	\$68.75
	06/01/2022	\$43.83	\$8.60	\$17.32	\$0.00	\$69.75
	12/01/2022	\$44.83	\$8.60	\$17.32	\$0.00	\$70.75
	06/01/2023	\$45.83	\$8.60	\$17.32	\$0.00	\$71.75
	12/01/2023	\$47.08	\$8.60	\$17.32	\$0.00	\$73.00

For apprentice rates see "Apprentice- LABORER"

Classification	Effective Date	Base Wage	Health	Pension	Supplemental Unemployment	Total Rate
DEMO: CONCRETE CUTTER/SAWYER <i>LABORERS - ZONE 1</i>	12/01/2020	\$41.05	\$8.60	\$17.32	\$0.00	\$66.97
	06/01/2021	\$42.07	\$8.60	\$17.32	\$0.00	\$67.99
	12/01/2021	\$43.08	\$8.60	\$17.32	\$0.00	\$69.00
	06/01/2022	\$44.08	\$8.60	\$17.32	\$0.00	\$70.00
	12/01/2022	\$45.08	\$8.60	\$17.32	\$0.00	\$71.00
	06/01/2023	\$46.08	\$8.60	\$17.32	\$0.00	\$72.00
	12/01/2023	\$47.33	\$8.60	\$17.32	\$0.00	\$73.25
For apprentice rates see "Apprentice- LABORER"						
DEMO: JACKHAMMER OPERATOR <i>LABORERS - ZONE 1</i>	12/01/2020	\$40.80	\$8.60	\$17.32	\$0.00	\$66.72
	06/01/2021	\$41.82	\$8.60	\$17.32	\$0.00	\$67.74
	12/01/2021	\$42.83	\$8.60	\$17.32	\$0.00	\$68.75
	06/01/2022	\$43.83	\$8.60	\$17.32	\$0.00	\$69.75
	12/01/2022	\$44.83	\$8.60	\$17.32	\$0.00	\$70.75
	06/01/2023	\$45.83	\$8.60	\$17.32	\$0.00	\$71.75
	12/01/2023	\$47.08	\$8.60	\$17.32	\$0.00	\$73.00
For apprentice rates see "Apprentice- LABORER"						
DEMO: WRECKING LABORER <i>LABORERS - ZONE 1</i>	12/01/2020	\$40.05	\$8.60	\$17.32	\$0.00	\$65.97
	06/01/2021	\$41.07	\$8.60	\$17.32	\$0.00	\$66.99
	12/01/2021	\$42.08	\$8.60	\$17.32	\$0.00	\$68.00
	06/01/2022	\$43.08	\$8.60	\$17.32	\$0.00	\$69.00
	12/01/2022	\$44.08	\$8.60	\$17.32	\$0.00	\$70.00
	06/01/2023	\$45.08	\$8.60	\$17.32	\$0.00	\$71.00
	12/01/2023	\$46.33	\$8.60	\$17.32	\$0.00	\$72.25
For apprentice rates see "Apprentice- LABORER"						
DIRECTIONAL DRILL MACHINE OPERATOR <i>OPERATING ENGINEERS LOCAL 4</i>	12/01/2020	\$49.45	\$13.50	\$15.70	\$0.00	\$78.65
	06/01/2021	\$50.54	\$13.50	\$15.70	\$0.00	\$79.74
	12/01/2021	\$51.68	\$13.50	\$15.70	\$0.00	\$80.88
For apprentice rates see "Apprentice- OPERATING ENGINEERS"						
DIVER <i>PILE DRIVER LOCAL 56 (ZONE 1)</i>	08/01/2020	\$68.70	\$9.40	\$23.12	\$0.00	\$101.22
For apprentice rates see "Apprentice- PILE DRIVER"						
DIVER TENDER <i>PILE DRIVER LOCAL 56 (ZONE 1)</i>	08/01/2020	\$49.07	\$9.40	\$23.12	\$0.00	\$81.59
For apprentice rates see "Apprentice- PILE DRIVER"						
DIVER TENDER (EFFLUENT) <i>PILE DRIVER LOCAL 56 (ZONE 1)</i>	08/01/2020	\$73.60	\$9.40	\$23.12	\$0.00	\$106.12
For apprentice rates see "Apprentice- PILE DRIVER"						
DIVER/SLURRY (EFFLUENT) <i>PILE DRIVER LOCAL 56 (ZONE 1)</i>	08/01/2020	\$103.05	\$9.40	\$23.12	\$0.00	\$135.57
For apprentice rates see "Apprentice- PILE DRIVER"						
DRAWBRIDGE OPERATOR (Construction) <i>DRAWBRIDGE - SEIU LOCAL 888</i>	07/01/2020	\$26.77	\$6.67	\$3.93	\$0.16	\$37.53
ELECTRICIAN <i>ELECTRICIANS LOCAL 103</i>	09/01/2020	\$54.45	\$13.00	\$19.73	\$0.00	\$87.18
	03/01/2021	\$55.41	\$13.00	\$20.01	\$0.00	\$88.42
	09/01/2021	\$56.84	\$13.00	\$20.06	\$0.00	\$89.90
	03/01/2022	\$58.04	\$13.00	\$20.09	\$0.00	\$91.13
	09/01/2022	\$59.48	\$13.00	\$20.13	\$0.00	\$92.61
	03/01/2023	\$60.67	\$13.00	\$20.17	\$0.00	\$93.84

Classification

Effective Date Base Wage Health Pension Supplemental Unemployment Total Rate

Apprentice - ELECTRICIAN - Local 103

Effective Date - 09/01/2020

Step	percent	Apprentice Base Wage	Health	Pension	Supplemental Unemployment	Total Rate
1	40	\$21.78	\$13.00	\$0.65	\$0.00	\$35.43
2	40	\$21.78	\$13.00	\$0.65	\$0.00	\$35.43
3	45	\$24.50	\$13.00	\$14.87	\$0.00	\$52.37
4	45	\$24.50	\$13.00	\$14.87	\$0.00	\$52.37
5	50	\$27.23	\$13.00	\$15.31	\$0.00	\$55.54
6	55	\$29.95	\$13.00	\$15.75	\$0.00	\$58.70
7	60	\$32.67	\$13.00	\$16.19	\$0.00	\$61.86
8	65	\$35.39	\$13.00	\$16.63	\$0.00	\$65.02
9	70	\$38.12	\$13.00	\$17.07	\$0.00	\$68.19
10	75	\$40.84	\$13.00	\$17.53	\$0.00	\$71.37

Effective Date - 03/01/2021

Step	percent	Apprentice Base Wage	Health	Pension	Supplemental Unemployment	Total Rate
1	40	\$22.16	\$13.00	\$0.66	\$0.00	\$35.82
2	40	\$22.16	\$13.00	\$0.66	\$0.00	\$35.82
3	45	\$24.93	\$13.00	\$15.13	\$0.00	\$53.06
4	45	\$24.93	\$13.00	\$15.13	\$0.00	\$53.06
5	50	\$27.71	\$13.00	\$15.57	\$0.00	\$56.28
6	55	\$30.48	\$13.00	\$16.01	\$0.00	\$59.49
7	60	\$33.25	\$13.00	\$16.46	\$0.00	\$62.71
8	65	\$36.02	\$13.00	\$16.90	\$0.00	\$65.92
9	70	\$38.79	\$13.00	\$17.34	\$0.00	\$69.13
10	75	\$41.56	\$13.00	\$17.80	\$0.00	\$72.36

Notes :
 App Prior 1/1/03; 30/35/40/45/50/55/65/70/75/80

Apprentice to Journeyworker Ratio:2:3***

ELEVATOR CONSTRUCTOR	01/01/2021	\$63.47	\$15.88	\$19.31	\$0.00	\$98.66
ELEVATOR CONSTRUCTORS LOCAL 4	01/01/2022	\$65.62	\$16.03	\$20.21	\$0.00	\$101.86

Apprentice - ELEVATOR CONSTRUCTOR - Local 4

Effective Date - 01/01/2021

Step	percent	Apprentice Base Wage	Health	Pension	Supplemental Unemployment	Total Rate
1	50	\$31.74	\$15.88	\$0.00	\$0.00	\$47.62
2	55	\$34.91	\$15.88	\$19.31	\$0.00	\$70.10
3	65	\$41.26	\$15.88	\$19.31	\$0.00	\$76.45
4	70	\$44.43	\$15.88	\$19.31	\$0.00	\$79.62
5	80	\$50.78	\$15.88	\$19.31	\$0.00	\$85.97

Effective Date - 01/01/2022

Step	percent	Apprentice Base Wage	Health	Pension	Supplemental Unemployment	Total Rate
1	50	\$32.81	\$16.03	\$0.00	\$0.00	\$48.84
2	55	\$36.09	\$16.03	\$20.21	\$0.00	\$72.33
3	65	\$42.65	\$16.03	\$20.21	\$0.00	\$78.89
4	70	\$45.93	\$16.03	\$20.21	\$0.00	\$82.17
5	80	\$52.50	\$16.03	\$20.21	\$0.00	\$88.74

Notes:

Steps 1-2 are 6 mos.; Steps 3-5 are 1 year

Apprentice to Journeyworker Ratio:1:1

ELEVATOR CONSTRUCTOR HELPER	01/01/2021	\$44.43	\$15.88	\$19.31	\$0.00	\$79.62
<i>ELEVATOR CONSTRUCTORS LOCAL 4</i>	01/01/2022	\$45.93	\$16.03	\$20.21	\$0.00	\$82.17
For apprentice rates see "Apprentice - ELEVATOR CONSTRUCTOR"						
FENCE & GUARD RAIL ERECTOR	12/01/2020	\$40.15	\$8.60	\$17.32	\$0.00	\$66.07
<i>LABORERS - ZONE 1</i>	06/01/2021	\$41.17	\$8.60	\$17.32	\$0.00	\$67.09
	12/01/2021	\$42.18	\$8.60	\$17.32	\$0.00	\$68.10
	06/01/2022	\$43.18	\$8.60	\$17.32	\$0.00	\$69.10
	12/01/2022	\$44.18	\$8.60	\$17.32	\$0.00	\$70.10
	06/01/2023	\$45.18	\$8.60	\$17.32	\$0.00	\$71.10
	12/01/2023	\$46.43	\$8.60	\$17.32	\$0.00	\$72.35
For apprentice rates see "Apprentice- LABORER"						
FENCE & GUARD RAIL ERECTOR (HEAVY & HIGHWAY)	12/01/2020	\$40.15	\$8.60	\$17.32	\$0.00	\$66.07
<i>LABORERS - ZONE 1 (HEAVY & HIGHWAY)</i>	06/01/2021	\$41.17	\$8.60	\$17.32	\$0.00	\$67.09
	12/01/2021	\$42.18	\$8.60	\$17.32	\$0.00	\$68.10
For apprentice rates see "Apprentice- LABORER (Heavy and Highway)"						
FIELD ENG.INST.PERSON-BLDG,SITE,HVY/HWY	11/01/2020	\$45.23	\$13.00	\$15.70	\$0.00	\$73.93
<i>OPERATING ENGINEERS LOCAL 4</i>	05/01/2021	\$46.38	\$13.00	\$15.70	\$0.00	\$75.08
	11/01/2021	\$47.38	\$13.00	\$15.70	\$0.00	\$76.08
	05/01/2022	\$48.53	\$13.00	\$15.70	\$0.00	\$77.23
For apprentice rates see "Apprentice- OPERATING ENGINEERS"						
FIELD ENG.PARTY CHIEF-BLDG,SITE,HVY/HWY	11/01/2020	\$46.74	\$13.00	\$15.70	\$0.00	\$75.44
<i>OPERATING ENGINEERS LOCAL 4</i>	05/01/2021	\$47.90	\$13.00	\$15.70	\$0.00	\$76.60
	11/01/2021	\$48.91	\$13.00	\$15.70	\$0.00	\$77.61
	05/01/2022	\$50.07	\$13.00	\$15.70	\$0.00	\$78.77
For apprentice rates see "Apprentice- OPERATING ENGINEERS"						

Classification	Effective Date	Base Wage	Health	Pension	Supplemental Unemployment	Total Rate
FIELD ENG.ROD PERSON-BLDG,SITE,HVY/HWY <i>OPERATING ENGINEERS LOCAL 4</i>	11/01/2020	\$22.73	\$13.00	\$15.70	\$0.00	\$51.43
	05/01/2021	\$23.41	\$13.00	\$15.70	\$0.00	\$52.11
	11/01/2021	\$24.01	\$13.00	\$15.70	\$0.00	\$52.71
	05/01/2022	\$24.68	\$13.00	\$15.70	\$0.00	\$53.38
For apprentice rates see "Apprentice- OPERATING ENGINEERS"						
FIRE ALARM INSTALLER <i>ELECTRICIANS LOCAL 103</i>	09/01/2020	\$54.45	\$13.00	\$19.73	\$0.00	\$87.18
	03/01/2021	\$55.41	\$13.00	\$20.01	\$0.00	\$88.42
	09/01/2021	\$56.84	\$13.00	\$20.06	\$0.00	\$89.90
	03/01/2022	\$58.04	\$13.00	\$20.09	\$0.00	\$91.13
	09/01/2022	\$59.48	\$13.00	\$20.13	\$0.00	\$92.61
	03/01/2023	\$60.67	\$13.00	\$20.17	\$0.00	\$93.84
For apprentice rates see "Apprentice- ELECTRICIAN"						
FIRE ALARM REPAIR / MAINTENANCE / COMMISSIONING <i>ELECTRICIANS LOCAL 103</i>	09/01/2020	\$40.84	\$13.00	\$17.53	\$0.00	\$71.37
	03/01/2021	\$42.11	\$13.00	\$17.88	\$0.00	\$72.99
	09/01/2021	\$43.77	\$13.00	\$18.00	\$0.00	\$74.77
	03/01/2022	\$45.27	\$13.00	\$18.12	\$0.00	\$76.39
	09/01/2022	\$46.99	\$13.00	\$18.24	\$0.00	\$78.23
	03/01/2023	\$48.54	\$13.00	\$18.37	\$0.00	\$79.91
For apprentice rates see "Apprentice- TELECOMMUNICATIONS TECHNICIAN"						
FIREMAN (ASST. ENGINEER) <i>OPERATING ENGINEERS LOCAL 4</i>	12/01/2020	\$40.75	\$13.50	\$15.70	\$0.00	\$69.95
	06/01/2021	\$41.66	\$13.50	\$15.70	\$0.00	\$70.86
	12/01/2021	\$42.61	\$13.50	\$15.70	\$0.00	\$71.81
For apprentice rates see "Apprentice- OPERATING ENGINEERS"						
FLAGGER & SIGNALER (HEAVY & HIGHWAY) <i>LABORERS - ZONE 1 (HEAVY & HIGHWAY)</i>	12/01/2020	\$24.50	\$8.60	\$17.32	\$0.00	\$50.42
	06/01/2021	\$24.50	\$8.60	\$17.32	\$0.00	\$50.42
	12/01/2021	\$24.50	\$8.60	\$17.32	\$0.00	\$50.42
For apprentice rates see "Apprentice- LABORER (Heavy and Highway)"						
FLOORCOVERER <i>FLOORCOVERERS LOCAL 2168 ZONE 1</i>	09/01/2020	\$47.79	\$9.40	\$19.25	\$0.00	\$76.44
	03/01/2021	\$48.59	\$9.40	\$19.25	\$0.00	\$77.24
	09/01/2021	\$49.39	\$9.40	\$19.25	\$0.00	\$78.04
	03/01/2022	\$50.19	\$9.40	\$19.25	\$0.00	\$78.84

Classification

Effective Date Base Wage Health Pension Supplemental Unemployment Total Rate

Apprentice - FLOORCOVERER - Local 2168 Zone I

Effective Date - 09/01/2020

Step	percent	Apprentice Base Wage	Health	Pension	Supplemental Unemployment	Total Rate
1	50	\$23.90	\$9.40	\$1.79	\$0.00	\$35.09
2	55	\$26.28	\$9.40	\$1.79	\$0.00	\$37.47
3	60	\$28.67	\$9.40	\$13.88	\$0.00	\$51.95
4	65	\$31.06	\$9.40	\$13.88	\$0.00	\$54.34
5	70	\$33.45	\$9.40	\$15.67	\$0.00	\$58.52
6	75	\$35.84	\$9.40	\$15.67	\$0.00	\$60.91
7	80	\$38.23	\$9.40	\$17.46	\$0.00	\$65.09
8	85	\$40.62	\$9.40	\$17.46	\$0.00	\$67.48

Effective Date - 03/01/2021

Step	percent	Apprentice Base Wage	Health	Pension	Supplemental Unemployment	Total Rate
1	50	\$24.30	\$9.40	\$1.79	\$0.00	\$35.49
2	55	\$26.72	\$9.40	\$1.79	\$0.00	\$37.91
3	60	\$29.15	\$9.40	\$13.88	\$0.00	\$52.43
4	65	\$31.58	\$9.40	\$13.88	\$0.00	\$54.86
5	70	\$34.01	\$9.40	\$15.67	\$0.00	\$59.08
6	75	\$36.44	\$9.40	\$15.67	\$0.00	\$61.51
7	80	\$38.87	\$9.40	\$17.46	\$0.00	\$65.73
8	85	\$41.30	\$9.40	\$17.46	\$0.00	\$68.16

Notes: Steps are 750 hrs.
 % After 09/1/17; 45/45/55/55/70/70/80/80 (1500hr Steps)
 Step 1&2 \$32.70/ 3&4 \$39.20/ 5&6 \$58.52/ 7&8 \$65.09

Apprentice to Journeyworker Ratio:1:1

FORK LIFT/CHERRY PICKER <i>OPERATING ENGINEERS LOCAL 4</i>	12/01/2020	\$49.98	\$13.50	\$15.70	\$0.00	\$79.18
	06/01/2021	\$51.08	\$13.50	\$15.70	\$0.00	\$80.28
	12/01/2021	\$52.23	\$13.50	\$15.70	\$0.00	\$81.43
For apprentice rates see "Apprentice- OPERATING ENGINEERS"						
GENERATOR/LIGHTING PLANT/HEATERS <i>OPERATING ENGINEERS LOCAL 4</i>	12/01/2020	\$33.00	\$13.50	\$15.70	\$0.00	\$62.20
	06/01/2021	\$33.75	\$13.50	\$15.70	\$0.00	\$62.95
	12/01/2021	\$34.54	\$13.50	\$15.70	\$0.00	\$63.74
For apprentice rates see "Apprentice- OPERATING ENGINEERS"						
GLAZIER (GLASS PLANK/AIR BARRIER/INTERIOR SYSTEMS) <i>GLAZIERS LOCAL 35 (ZONE 1)</i>	01/01/2021	\$47.35	\$8.25	\$22.75	\$0.00	\$78.35

Classification

Effective Date Base Wage Health Pension Supplemental Unemployment Total Rate

Apprentice - GLAZIER - Local 35 Zone 1

Effective Date - 01/01/2021

Step	percent	Apprentice Base Wage	Health	Pension	Supplemental Unemployment	Total Rate
1	50	\$23.68	\$8.25	\$0.00	\$0.00	\$31.93
2	55	\$26.04	\$8.25	\$6.16	\$0.00	\$40.45
3	60	\$28.41	\$8.25	\$6.72	\$0.00	\$43.38
4	65	\$30.78	\$8.25	\$7.28	\$0.00	\$46.31
5	70	\$33.15	\$8.25	\$19.39	\$0.00	\$60.79
6	75	\$35.51	\$8.25	\$19.95	\$0.00	\$63.71
7	80	\$37.88	\$8.25	\$20.51	\$0.00	\$66.64
8	90	\$42.62	\$8.25	\$21.63	\$0.00	\$72.50

Notes:
Steps are 750 hrs.

Apprentice to Journeyworker Ratio:1:1

HOISTING ENGINEER/CRANES/GRADALLS	12/01/2020	\$49.98	\$13.50	\$15.70	\$0.00	\$79.18
OPERATING ENGINEERS LOCAL 4	06/01/2021	\$51.08	\$13.50	\$15.70	\$0.00	\$80.28
	12/01/2021	\$52.23	\$13.50	\$15.70	\$0.00	\$81.43

Classification

Effective Date Base Wage Health Pension Supplemental Unemployment Total Rate

Apprentice - OPERATING ENGINEERS - Local 4

Effective Date - 12/01/2020

Step	percent	Apprentice Base Wage	Health	Pension	Supplemental Unemployment	Total Rate
1	55	\$27.49	\$13.50	\$0.00	\$0.00	\$40.99
2	60	\$29.99	\$13.50	\$15.70	\$0.00	\$59.19
3	65	\$32.49	\$13.50	\$15.70	\$0.00	\$61.69
4	70	\$34.99	\$13.50	\$15.70	\$0.00	\$64.19
5	75	\$37.49	\$13.50	\$15.70	\$0.00	\$66.69
6	80	\$39.98	\$13.50	\$15.70	\$0.00	\$69.18
7	85	\$42.48	\$13.50	\$15.70	\$0.00	\$71.68
8	90	\$44.98	\$13.50	\$15.70	\$0.00	\$74.18

Effective Date - 06/01/2021

Step	percent	Apprentice Base Wage	Health	Pension	Supplemental Unemployment	Total Rate
1	55	\$28.09	\$13.50	\$0.00	\$0.00	\$41.59
2	60	\$30.65	\$13.50	\$15.70	\$0.00	\$59.85
3	65	\$33.20	\$13.50	\$15.70	\$0.00	\$62.40
4	70	\$35.76	\$13.50	\$15.70	\$0.00	\$64.96
5	75	\$38.31	\$13.50	\$15.70	\$0.00	\$67.51
6	80	\$40.86	\$13.50	\$15.70	\$0.00	\$70.06
7	85	\$43.42	\$13.50	\$15.70	\$0.00	\$72.62
8	90	\$45.97	\$13.50	\$15.70	\$0.00	\$75.17

Notes:

Apprentice to Journeyworker Ratio:1:6

HVAC (DUCTWORK) SHEETMETAL WORKERS LOCAL 17 - A	08/01/2020	\$50.67	\$13.50	\$24.12	\$2.65	\$90.94
	02/01/2021	\$52.32	\$13.50	\$24.12	\$2.70	\$92.64
	08/01/2021	\$54.07	\$13.50	\$24.12	\$2.75	\$94.44
	02/01/2022	\$55.82	\$13.50	\$24.12	\$2.80	\$96.24

For apprentice rates see "Apprentice- SHEET METAL WORKER"

HVAC (ELECTRICAL CONTROLS) ELECTRICIANS LOCAL 103	09/01/2020	\$54.45	\$13.00	\$19.73	\$0.00	\$87.18
	03/01/2021	\$55.41	\$13.00	\$20.01	\$0.00	\$88.42
	09/01/2021	\$56.84	\$13.00	\$20.06	\$0.00	\$89.90
	03/01/2022	\$58.04	\$13.00	\$20.09	\$0.00	\$91.13
	09/01/2022	\$59.48	\$13.00	\$20.13	\$0.00	\$92.61
	03/01/2023	\$60.67	\$13.00	\$20.17	\$0.00	\$93.84

For apprentice rates see "Apprentice- ELECTRICIAN"

HVAC (TESTING AND BALANCING - AIR) SHEETMETAL WORKERS LOCAL 17 - A	08/01/2020	\$50.67	\$13.50	\$24.12	\$2.65	\$90.94
	02/01/2021	\$52.32	\$13.50	\$24.12	\$2.70	\$92.64
	08/01/2021	\$54.07	\$13.50	\$24.12	\$2.75	\$94.44
	02/01/2022	\$55.82	\$13.50	\$24.12	\$2.80	\$96.24

For apprentice rates see "Apprentice- SHEET METAL WORKER"

Classification	Effective Date	Base Wage	Health	Pension	Supplemental Unemployment	Total Rate
HVAC (TESTING AND BALANCING - WATER) <i>PIPEFITTERS LOCAL 537</i>	09/01/2020	\$56.44	\$11.70	\$20.24	\$0.00	\$88.38
	03/01/2021	\$57.94	\$11.70	\$20.24	\$0.00	\$89.88
For apprentice rates see "Apprentice- PIPEFITTER" or "PLUMBER/PIPEFITTER"						
HVAC MECHANIC <i>PIPEFITTERS LOCAL 537</i>	09/01/2020	\$56.44	\$11.70	\$20.24	\$0.00	\$88.38
	03/01/2021	\$57.94	\$11.70	\$20.24	\$0.00	\$89.88
For apprentice rates see "Apprentice- PIPEFITTER" or "PLUMBER/PIPEFITTER"						
HYDRAULIC DRILLS <i>LABORERS - ZONE 1</i>	12/01/2020	\$40.65	\$8.60	\$17.32	\$0.00	\$66.57
	06/01/2021	\$41.67	\$8.60	\$17.32	\$0.00	\$67.59
	12/01/2021	\$42.68	\$8.60	\$17.32	\$0.00	\$68.60
	06/01/2022	\$43.68	\$8.60	\$17.32	\$0.00	\$69.60
	12/01/2022	\$44.68	\$8.60	\$17.32	\$0.00	\$70.60
	06/01/2023	\$45.68	\$8.60	\$17.32	\$0.00	\$71.60
For apprentice rates see "Apprentice- LABORER"						
HYDRAULIC DRILLS (HEAVY & HIGHWAY) <i>LABORERS - ZONE 1 (HEAVY & HIGHWAY)</i>	12/01/2020	\$40.65	\$8.60	\$17.32	\$0.00	\$66.57
	06/01/2021	\$41.67	\$8.60	\$17.32	\$0.00	\$67.59
	12/01/2021	\$42.68	\$8.60	\$17.32	\$0.00	\$68.60
For apprentice rates see "Apprentice- LABORER (Heavy and Highway)"						
INSULATOR (PIPES & TANKS) <i>HEAT & FROST INSULATORS LOCAL 6 (BOSTON)</i>	09/01/2020	\$49.00	\$13.80	\$17.14	\$0.00	\$79.94
	09/01/2021	\$51.40	\$13.80	\$17.14	\$0.00	\$82.34
	09/01/2022	\$53.85	\$13.80	\$17.14	\$0.00	\$84.79

Apprentice - ASBESTOS INSULATOR (Pipes & Tanks) - Local 6 Boston

Effective Date - 09/01/2020

Step	percent	Apprentice Base Wage	Health	Pension	Supplemental Unemployment	Total Rate
1	50	\$24.50	\$13.80	\$12.42	\$0.00	\$50.72
2	60	\$29.40	\$13.80	\$13.36	\$0.00	\$56.56
3	70	\$34.30	\$13.80	\$14.31	\$0.00	\$62.41
4	80	\$39.20	\$13.80	\$15.25	\$0.00	\$68.25

Effective Date - 09/01/2021

Step	percent	Apprentice Base Wage	Health	Pension	Supplemental Unemployment	Total Rate
1	50	\$25.70	\$13.80	\$12.42	\$0.00	\$51.92
2	60	\$30.84	\$13.80	\$13.36	\$0.00	\$58.00
3	70	\$35.98	\$13.80	\$14.31	\$0.00	\$64.09
4	80	\$41.12	\$13.80	\$15.25	\$0.00	\$70.17

Notes:

Steps are 1 year

Apprentice to Journeyworker Ratio:1:4

IRONWORKER/WELDER <i>IRONWORKERS LOCAL 7 (BOSTON AREA)</i>	09/16/2020	\$48.66	\$8.10	\$25.10	\$0.00	\$81.86
---	------------	---------	--------	---------	--------	---------

Classification

Effective Date Base Wage Health Pension Supplemental Unemployment Total Rate

Apprentice - IRONWORKER - Local 7 Boston

Effective Date - 09/16/2020

Step	percent	Apprentice Base Wage	Health	Pension	Supplemental Unemployment	Total Rate
1	60	\$29.20	\$8.10	\$25.10	\$0.00	\$62.40
2	70	\$34.06	\$8.10	\$25.10	\$0.00	\$67.26
3	75	\$36.50	\$8.10	\$25.10	\$0.00	\$69.70
4	80	\$38.93	\$8.10	\$25.10	\$0.00	\$72.13
5	85	\$41.36	\$8.10	\$25.10	\$0.00	\$74.56
6	90	\$43.79	\$8.10	\$25.10	\$0.00	\$76.99

Notes:

** Structural 1:6; Ornamental 1:4

Apprentice to Journeyworker Ratio:**

JACKHAMMER & PAVING BREAKER OPERATOR LABORERS - ZONE 1	12/01/2020	\$40.15	\$8.60	\$17.32	\$0.00	\$66.07
	06/01/2021	\$41.17	\$8.60	\$17.32	\$0.00	\$67.09
	12/01/2021	\$42.18	\$8.60	\$17.32	\$0.00	\$68.10
	06/01/2022	\$43.18	\$8.60	\$17.32	\$0.00	\$69.10
	12/01/2022	\$44.18	\$8.60	\$17.32	\$0.00	\$70.10
	06/01/2023	\$45.18	\$8.60	\$17.32	\$0.00	\$71.10
	12/01/2023	\$46.43	\$8.60	\$17.32	\$0.00	\$72.35

For apprentice rates see "Apprentice- LABORER"

LABORER LABORERS - ZONE 1	12/01/2020	\$39.90	\$8.60	\$17.32	\$0.00	\$65.82
	06/01/2021	\$40.92	\$8.60	\$17.32	\$0.00	\$66.84
	12/01/2021	\$41.93	\$8.60	\$17.32	\$0.00	\$67.85
	06/01/2022	\$42.93	\$8.60	\$17.32	\$0.00	\$68.85
	12/01/2022	\$43.93	\$8.60	\$17.32	\$0.00	\$69.85
	06/01/2023	\$44.93	\$8.60	\$17.32	\$0.00	\$70.85
	12/01/2023	\$46.18	\$8.60	\$17.32	\$0.00	\$72.10

Classification

Effective Date Base Wage Health Pension Supplemental Unemployment Total Rate

Apprentice - LABORER - Zone 1

Effective Date - 12/01/2020

Step	percent	Apprentice Base Wage	Health	Pension	Supplemental Unemployment	Total Rate
1	60	\$23.94	\$8.60	\$17.32	\$0.00	\$49.86
2	70	\$27.93	\$8.60	\$17.32	\$0.00	\$53.85
3	80	\$31.92	\$8.60	\$17.32	\$0.00	\$57.84
4	90	\$35.91	\$8.60	\$17.32	\$0.00	\$61.83

Effective Date - 06/01/2021

Step	percent	Apprentice Base Wage	Health	Pension	Supplemental Unemployment	Total Rate
1	60	\$24.55	\$8.60	\$17.32	\$0.00	\$50.47
2	70	\$28.64	\$8.60	\$17.32	\$0.00	\$54.56
3	80	\$32.74	\$8.60	\$17.32	\$0.00	\$58.66
4	90	\$36.83	\$8.60	\$17.32	\$0.00	\$62.75

Notes:

Apprentice to Journeyworker Ratio:1:5

LABORER (HEAVY & HIGHWAY)	12/01/2020	\$39.90	\$8.60	\$17.32	\$0.00	\$65.82
LABORERS - ZONE 1 (HEAVY & HIGHWAY)	06/01/2021	\$40.92	\$8.60	\$17.32	\$0.00	\$66.84
	12/01/2021	\$41.93	\$8.60	\$17.32	\$0.00	\$67.85

Apprentice - LABORER (Heavy & Highway) - Zone 1

Effective Date - 12/01/2020

Step	percent	Apprentice Base Wage	Health	Pension	Supplemental Unemployment	Total Rate
1	60	\$23.94	\$8.60	\$17.32	\$0.00	\$49.86
2	70	\$27.93	\$8.60	\$17.32	\$0.00	\$53.85
3	80	\$31.92	\$8.60	\$17.32	\$0.00	\$57.84
4	90	\$35.91	\$8.60	\$17.32	\$0.00	\$61.83

Effective Date - 06/01/2021

Step	percent	Apprentice Base Wage	Health	Pension	Supplemental Unemployment	Total Rate
1	60	\$24.55	\$8.60	\$17.32	\$0.00	\$50.47
2	70	\$28.64	\$8.60	\$17.32	\$0.00	\$54.56
3	80	\$32.74	\$8.60	\$17.32	\$0.00	\$58.66
4	90	\$36.83	\$8.60	\$17.32	\$0.00	\$62.75

Notes:

Apprentice to Journeyworker Ratio:1:5

Classification	Effective Date	Base Wage	Health	Pension	Supplemental Unemployment	Total Rate
LABORER: CARPENTER TENDER <i>LABORERS - ZONE 1</i>	12/01/2020	\$39.90	\$8.60	\$17.32	\$0.00	\$65.82
	06/01/2021	\$40.92	\$8.60	\$17.32	\$0.00	\$66.84
	12/01/2021	\$41.93	\$8.60	\$17.32	\$0.00	\$67.85
	06/01/2022	\$42.93	\$8.60	\$17.32	\$0.00	\$68.85
	12/01/2022	\$43.93	\$8.60	\$17.32	\$0.00	\$69.85
	06/01/2023	\$44.93	\$8.60	\$17.32	\$0.00	\$70.85
	12/01/2023	\$46.18	\$8.60	\$17.32	\$0.00	\$72.10
For apprentice rates see "Apprentice- LABORER"						
LABORER: CEMENT FINISHER TENDER <i>LABORERS - ZONE 1</i>	12/01/2020	\$39.90	\$8.60	\$17.32	\$0.00	\$65.82
	06/01/2021	\$40.92	\$8.60	\$17.32	\$0.00	\$66.84
	12/01/2021	\$41.93	\$8.60	\$17.32	\$0.00	\$67.85
	06/01/2022	\$42.93	\$8.60	\$17.32	\$0.00	\$68.85
	12/01/2022	\$43.93	\$8.60	\$17.32	\$0.00	\$69.85
	06/01/2023	\$44.93	\$8.60	\$17.32	\$0.00	\$70.85
	12/01/2023	\$46.18	\$8.60	\$17.32	\$0.00	\$72.10
For apprentice rates see "Apprentice- LABORER"						
LABORER: HAZARDOUS WASTE/ASBESTOS REMOVER <i>LABORERS - ZONE 1</i>	12/01/2020	\$40.05	\$8.60	\$17.32	\$0.00	\$65.97
	06/01/2021	\$41.07	\$8.60	\$17.32	\$0.00	\$66.99
	12/01/2021	\$42.08	\$8.60	\$17.32	\$0.00	\$68.00
	06/01/2022	\$43.08	\$8.60	\$17.32	\$0.00	\$69.00
	12/01/2022	\$44.08	\$8.60	\$17.32	\$0.00	\$70.00
	06/01/2023	\$45.08	\$8.60	\$17.32	\$0.00	\$71.00
	12/01/2023	\$46.33	\$8.60	\$17.32	\$0.00	\$72.25
For apprentice rates see "Apprentice- LABORER"						
LABORER: MASON TENDER <i>LABORERS - ZONE 1</i>	12/01/2020	\$40.15	\$8.60	\$17.32	\$0.00	\$66.07
	06/01/2021	\$41.17	\$8.60	\$17.32	\$0.00	\$67.09
	12/01/2021	\$42.18	\$8.60	\$17.32	\$0.00	\$68.10
	06/01/2022	\$43.18	\$8.60	\$17.32	\$0.00	\$69.10
	12/01/2022	\$44.18	\$8.60	\$17.32	\$0.00	\$70.10
	06/01/2023	\$45.18	\$8.60	\$17.32	\$0.00	\$71.10
	06/01/2024	\$46.43	\$8.60	\$17.32	\$0.00	\$72.35
For apprentice rates see "Apprentice- LABORER"						
LABORER: MASON TENDER (HEAVY & HIGHWAY) <i>LABORERS - ZONE 1 (HEAVY & HIGHWAY)</i>	12/01/2020	\$40.15	\$8.60	\$17.32	\$0.00	\$66.07
	06/01/2021	\$41.17	\$8.60	\$17.32	\$0.00	\$67.09
	12/01/2021	\$42.18	\$8.60	\$17.32	\$0.00	\$68.10
For apprentice rates see "Apprentice- LABORER (Heavy and Highway)"						
LABORER: MULTI-TRADE TENDER <i>LABORERS - ZONE 1</i>	12/01/2020	\$39.90	\$8.60	\$17.32	\$0.00	\$65.82
	06/01/2021	\$40.92	\$8.60	\$17.32	\$0.00	\$66.84
	12/01/2021	\$41.93	\$8.60	\$17.32	\$0.00	\$67.85
	06/01/2022	\$42.93	\$8.60	\$17.32	\$0.00	\$68.85
	12/01/2022	\$43.93	\$8.60	\$17.32	\$0.00	\$69.85
	06/01/2023	\$44.93	\$8.60	\$17.32	\$0.00	\$70.85
	12/01/2023	\$46.18	\$8.60	\$17.32	\$0.00	\$72.10
For apprentice rates see "Apprentice- LABORER"						

Classification	Effective Date	Base Wage	Health	Pension	Supplemental Unemployment	Total Rate
LABORER: TREE REMOVER <i>LABORERS - ZONE 1</i>	12/01/2020	\$39.90	\$8.60	\$17.32	\$0.00	\$65.82
	06/01/2021	\$40.92	\$8.60	\$17.32	\$0.00	\$66.84
	12/01/2021	\$41.93	\$8.60	\$17.32	\$0.00	\$67.85
	06/01/2022	\$42.93	\$8.60	\$17.32	\$0.00	\$68.85
	12/01/2022	\$43.93	\$8.60	\$17.32	\$0.00	\$69.85
	06/01/2023	\$44.93	\$8.60	\$17.32	\$0.00	\$70.85
	12/01/2023	\$46.18	\$8.60	\$17.32	\$0.00	\$72.10
This classification applies to the removal of standing trees, and the trimming and removal of branches and limbs when related to public works construction or site clearance incidental to construction . For apprentice rates see "Apprentice- LABORER"						
LASER BEAM OPERATOR <i>LABORERS - ZONE 1</i>	12/01/2020	\$40.15	\$8.60	\$17.32	\$0.00	\$66.07
	06/01/2021	\$41.17	\$8.60	\$17.32	\$0.00	\$67.09
	12/01/2021	\$42.18	\$8.60	\$17.32	\$0.00	\$68.10
	06/01/2022	\$43.18	\$8.60	\$17.32	\$0.00	\$69.10
	12/01/2022	\$44.18	\$8.60	\$17.32	\$0.00	\$70.10
	06/01/2023	\$45.18	\$8.60	\$17.32	\$0.00	\$71.10
	12/01/2023	\$46.43	\$8.60	\$17.32	\$0.00	\$72.35
For apprentice rates see "Apprentice- LABORER"						
LASER BEAM OPERATOR (HEAVY & HIGHWAY) <i>LABORERS - ZONE 1 (HEAVY & HIGHWAY)</i>	12/01/2020	\$40.15	\$8.60	\$17.32	\$0.00	\$66.07
	06/01/2021	\$41.17	\$8.60	\$17.32	\$0.00	\$67.09
	12/01/2021	\$42.18	\$8.60	\$17.32	\$0.00	\$68.10
For apprentice rates see "Apprentice- LABORER (Heavy and Highway)"						
MARBLE & TILE FINISHERS <i>BRICKLAYERS LOCAL 3 - MARBLE & TILE</i>	08/01/2020	\$42.57	\$10.75	\$20.27	\$0.00	\$73.59
	02/01/2021	\$43.08	\$10.75	\$20.27	\$0.00	\$74.10
	08/01/2021	\$44.20	\$10.75	\$20.43	\$0.00	\$75.38
	02/01/2022	\$44.67	\$10.75	\$20.43	\$0.00	\$75.85

Apprentice - MARBLE & TILE FINISHER - Local 3 Marble & Tile

Effective Date - 08/01/2020

Step	percent	Apprentice Base Wage	Health	Pension	Supplemental Unemployment	Total Rate
1	50	\$21.29	\$10.75	\$20.27	\$0.00	\$52.31
2	60	\$25.54	\$10.75	\$20.27	\$0.00	\$56.56
3	70	\$29.80	\$10.75	\$20.27	\$0.00	\$60.82
4	80	\$34.06	\$10.75	\$20.27	\$0.00	\$65.08
5	90	\$38.31	\$10.75	\$20.27	\$0.00	\$69.33

Effective Date - 02/01/2021

Step	percent	Apprentice Base Wage	Health	Pension	Supplemental Unemployment	Total Rate
1	50	\$21.54	\$10.75	\$20.27	\$0.00	\$52.56
2	60	\$25.85	\$10.75	\$20.27	\$0.00	\$56.87
3	70	\$30.16	\$10.75	\$20.27	\$0.00	\$61.18
4	80	\$34.46	\$10.75	\$20.27	\$0.00	\$65.48
5	90	\$38.77	\$10.75	\$20.27	\$0.00	\$69.79

Notes:

Apprentice to Journeyworker Ratio:1:3

Classification	Effective Date	Base Wage	Health	Pension	Supplemental Unemployment	Total Rate
MARBLE MASONS, TILELAYERS & TERRAZZO MECH <i>BRICKLAYERS LOCAL 3 - MARBLE & TILE</i>	08/01/2020	\$55.77	\$10.75	\$22.08	\$0.00	\$88.60
	02/01/2021	\$56.41	\$10.75	\$22.08	\$0.00	\$89.24
	08/01/2021	\$57.81	\$10.75	\$22.24	\$0.00	\$90.80
	02/01/2022	\$58.38	\$10.75	\$22.24	\$0.00	\$91.37

Apprentice - MARBLE-TILE-TERRAZZO MECHANIC - Local 3 Marble & Tile

Effective Date - 08/01/2020

Step	percent	Apprentice Base Wage	Health	Pension	Supplemental Unemployment	Total Rate
1	50	\$27.89	\$10.75	\$22.08	\$0.00	\$60.72
2	60	\$33.46	\$10.75	\$22.08	\$0.00	\$66.29
3	70	\$39.04	\$10.75	\$22.08	\$0.00	\$71.87
4	80	\$44.62	\$10.75	\$22.08	\$0.00	\$77.45
5	90	\$50.19	\$10.75	\$22.08	\$0.00	\$83.02

Effective Date - 02/01/2021

Step	percent	Apprentice Base Wage	Health	Pension	Supplemental Unemployment	Total Rate
1	50	\$28.21	\$10.75	\$22.08	\$0.00	\$61.04
2	60	\$33.85	\$10.75	\$22.08	\$0.00	\$66.68
3	70	\$39.49	\$10.75	\$22.08	\$0.00	\$72.32
4	80	\$45.13	\$10.75	\$22.08	\$0.00	\$77.96
5	90	\$50.77	\$10.75	\$22.08	\$0.00	\$83.60

Notes:

Apprentice to Journeyworker Ratio:1:5

MECH. SWEEPER OPERATOR (ON CONST. SITES) <i>OPERATING ENGINEERS LOCAL 4</i>	12/01/2020	\$49.45	\$13.50	\$15.70	\$0.00	\$78.65
	06/01/2021	\$50.54	\$13.50	\$15.70	\$0.00	\$79.74
	12/01/2021	\$51.68	\$13.50	\$15.70	\$0.00	\$80.88

For apprentice rates see "Apprentice- OPERATING ENGINEERS"

MECHANICS MAINTENANCE <i>OPERATING ENGINEERS LOCAL 4</i>	12/01/2020	\$49.45	\$13.50	\$15.70	\$0.00	\$78.65
	06/01/2021	\$50.54	\$13.50	\$15.70	\$0.00	\$79.74
	12/01/2021	\$51.68	\$13.50	\$15.70	\$0.00	\$80.88

For apprentice rates see "Apprentice- OPERATING ENGINEERS"

MILLWRIGHT (Zone 1) <i>MILLWRIGHTS LOCAL 1121 - Zone 1</i>	01/04/2021	\$44.07	\$9.40	\$20.45	\$0.00	\$73.92
	01/03/2022	\$45.82	\$9.40	\$20.45	\$0.00	\$75.67
	01/02/2023	\$47.57	\$9.40	\$20.45	\$0.00	\$77.42

Apprentice - MILLWRIGHT - Local 1121 Zone 1

Effective Date - 01/04/2021

Step	percent	Apprentice Base Wage	Health	Pension	Supplemental Unemployment	Total Rate
1	55	\$24.24	\$9.40	\$5.58	\$0.00	\$39.22
2	65	\$28.65	\$9.40	\$16.90	\$0.00	\$54.95
3	75	\$33.05	\$9.40	\$17.92	\$0.00	\$60.37
4	85	\$37.46	\$9.40	\$18.93	\$0.00	\$65.79

Notes: Step 1&2 Appr. indentured after 1/1/2020 receive no pension, but do receive annuity. (Step 1 \$5.58, Step 2 \$6.50)
Steps are 2,000 hours

Apprentice to Journeyworker Ratio:1:5

MORTAR MIXER LABORERS - ZONE 1	12/01/2020	\$40.15	\$8.60	\$17.32	\$0.00	\$66.07
	06/01/2021	\$41.17	\$8.60	\$17.32	\$0.00	\$67.09
	12/01/2021	\$42.18	\$8.60	\$17.32	\$0.00	\$68.10
	06/01/2022	\$43.18	\$8.60	\$17.32	\$0.00	\$69.10
	12/01/2022	\$44.18	\$8.60	\$17.32	\$0.00	\$70.10
	06/01/2023	\$45.18	\$8.60	\$17.32	\$0.00	\$71.10
	12/01/2023	\$46.43	\$8.60	\$17.32	\$0.00	\$72.35

For apprentice rates see "Apprentice- LABORER"

OILER (OTHER THAN TRUCK CRANES,GRADALLS) OPERATING ENGINEERS LOCAL 4	12/01/2020	\$23.20	\$13.50	\$15.70	\$0.00	\$52.40
	06/01/2021	\$23.75	\$13.50	\$15.70	\$0.00	\$52.95
	12/01/2021	\$24.33	\$13.50	\$15.70	\$0.00	\$53.53

For apprentice rates see "Apprentice- OPERATING ENGINEERS"

OILER (TRUCK CRANES, GRADALLS) OPERATING ENGINEERS LOCAL 4	12/01/2020	\$27.97	\$13.50	\$15.70	\$0.00	\$57.17
	06/01/2021	\$28.61	\$13.50	\$15.70	\$0.00	\$57.81
	12/01/2021	\$29.29	\$13.50	\$15.70	\$0.00	\$58.49

For apprentice rates see "Apprentice- OPERATING ENGINEERS"

OTHER POWER DRIVEN EQUIPMENT - CLASS II OPERATING ENGINEERS LOCAL 4	12/01/2020	\$49.45	\$13.50	\$15.70	\$0.00	\$78.65
	06/01/2021	\$50.54	\$13.50	\$15.70	\$0.00	\$79.74
	12/01/2021	\$51.68	\$13.50	\$15.70	\$0.00	\$80.88

For apprentice rates see "Apprentice- OPERATING ENGINEERS"

PAINTER (BRIDGES/TANKS) PAINTERS LOCAL 35 - ZONE 1	01/01/2021	\$52.06	\$8.25	\$22.75	\$0.00	\$83.06
---	------------	---------	--------	---------	--------	---------

Classification

Effective Date Base Wage Health Pension Supplemental Unemployment Total Rate

Apprentice - PAINTER Local 35 - BRIDGES/TANKS

Effective Date - 01/01/2021

Table with 8 columns: Step, percent, Apprentice Base Wage, Health, Pension, Supplemental Unemployment, Total Rate. Rows 1-8 showing wage progression from 50% to 90%.

Notes: Steps are 750 hrs.

Apprentice to Journeyworker Ratio:1:1

Summary row for PAINTER (SPRAY OR SANDBLAST, NEW) * with values: 01/01/2021, \$49.75, \$8.25, \$22.75, \$0.00, \$80.75

* If 30% or more of surfaces to be painted are new construction, NEW paint rate shall be used. PAINTERS LOCAL 35 - ZONE 1

Apprentice - PAINTER Local 35 Zone 1 - Spray/Sandblast - New

Effective Date - 01/01/2021

Table with 8 columns: Step, percent, Apprentice Base Wage, Health, Pension, Supplemental Unemployment, Total Rate. Rows 1-8 showing wage progression from 50% to 90%.

Notes: Steps are 750 hrs.

Apprentice to Journeyworker Ratio:1:1

Summary row for PAINTER (SPRAY OR SANDBLAST, REPAINT) with values: 01/01/2021, \$46.81, \$8.25, \$22.75, \$0.00, \$77.81

PAINTERS LOCAL 35 - ZONE 1

Classification

Effective Date Base Wage Health Pension Supplemental Unemployment Total Rate

Apprentice - PAINTER Local 35 Zone 1 - Spray/Sandblast - Repaint

Effective Date - 01/01/2021

Step	percent	Apprentice Base Wage	Health	Pension	Supplemental Unemployment	Total Rate
1	50	\$23.41	\$8.25	\$0.00	\$0.00	\$31.66
2	55	\$25.75	\$8.25	\$6.16	\$0.00	\$40.16
3	60	\$28.09	\$8.25	\$6.72	\$0.00	\$43.06
4	65	\$30.43	\$8.25	\$7.28	\$0.00	\$45.96
5	70	\$32.77	\$8.25	\$19.39	\$0.00	\$60.41
6	75	\$35.11	\$8.25	\$19.95	\$0.00	\$63.31
7	80	\$37.45	\$8.25	\$20.51	\$0.00	\$66.21
8	90	\$42.13	\$8.25	\$21.63	\$0.00	\$72.01

Notes:

Steps are 750 hrs.

Apprentice to Journeyworker Ratio:1:1

PAINTER / TAPER (BRUSH, NEW) *	01/01/2021	\$47.35	\$8.25	\$22.75	\$0.00	\$78.35
--------------------------------	------------	---------	--------	---------	--------	---------

* If 30% or more of surfaces to be painted are new construction, NEW paint rate shall be used. PAINTERS LOCAL 35 - ZONE 1

Apprentice - PAINTER - Local 35 Zone 1 - BRUSH NEW

Effective Date - 01/01/2021

Step	percent	Apprentice Base Wage	Health	Pension	Supplemental Unemployment	Total Rate
1	50	\$23.68	\$8.25	\$0.00	\$0.00	\$31.93
2	55	\$26.04	\$8.25	\$6.16	\$0.00	\$40.45
3	60	\$28.41	\$8.25	\$6.72	\$0.00	\$43.38
4	65	\$30.78	\$8.25	\$7.28	\$0.00	\$46.31
5	70	\$33.15	\$8.25	\$19.39	\$0.00	\$60.79
6	75	\$35.51	\$8.25	\$19.95	\$0.00	\$63.71
7	80	\$37.88	\$8.25	\$20.51	\$0.00	\$66.64
8	90	\$42.62	\$8.25	\$21.63	\$0.00	\$72.50

Notes:

Steps are 750 hrs.

Apprentice to Journeyworker Ratio:1:1

PAINTER / TAPER (BRUSH, REPAINT)	01/01/2021	\$45.41	\$8.25	\$22.75	\$0.00	\$76.41
----------------------------------	------------	---------	--------	---------	--------	---------

PAINTERS LOCAL 35 - ZONE 1

Classification

Effective Date Base Wage Health Pension Supplemental Unemployment Total Rate

Apprentice - PAINTER Local 35 Zone 1 - BRUSH REPAINT

Effective Date - 01/01/2021

Step	percent	Apprentice Base Wage	Health	Pension	Supplemental Unemployment	Total Rate
1	50	\$22.71	\$8.25	\$0.00	\$0.00	\$30.96
2	55	\$24.98	\$8.25	\$6.16	\$0.00	\$39.39
3	60	\$27.25	\$8.25	\$6.72	\$0.00	\$42.22
4	65	\$29.52	\$8.25	\$7.28	\$0.00	\$45.05
5	70	\$31.79	\$8.25	\$19.39	\$0.00	\$59.43
6	75	\$34.06	\$8.25	\$19.95	\$0.00	\$62.26
7	80	\$36.33	\$8.25	\$20.51	\$0.00	\$65.09
8	90	\$40.87	\$8.25	\$21.63	\$0.00	\$70.75

Notes:
Steps are 750 hrs.

Apprentice to Journeyworker Ratio:1:1

Painter Traffic Markings (Heavy/Highway) Laborers - Zone 1 (Heavy & Highway)	12/01/2020	\$39.90	\$8.60	\$17.32	\$0.00	\$65.82
	06/01/2021	\$40.92	\$8.60	\$17.32	\$0.00	\$66.84
	12/01/2021	\$41.93	\$8.60	\$17.32	\$0.00	\$67.85
For apprentice rates see "Apprentice- LABORER (Heavy and Highway)						
Panel & Pickup Trucks Driver Teamsters Joint Council No. 10 Zone A	12/01/2020	\$36.08	\$12.91	\$14.82	\$0.00	\$63.81
	06/01/2021	\$36.88	\$12.91	\$14.82	\$0.00	\$64.61
	08/01/2021	\$36.88	\$13.41	\$14.82	\$0.00	\$65.11
	12/01/2021	\$36.88	\$13.41	\$16.01	\$0.00	\$66.30
Pier and Dock Constructor (Underpinning and Deck) Pile Driver Local 56 (Zone 1)	08/01/2020	\$49.07	\$9.40	\$23.12	\$0.00	\$81.59
For apprentice rates see "Apprentice- PILE DRIVER"						
Pile Driver Pile Driver Local 56 (Zone 1)	08/01/2020	\$49.07	\$9.40	\$23.12	\$0.00	\$81.59

Apprentice - PILE DRIVER - Local 56 Zone 1

Effective Date - 08/01/2020

Step	percent	Apprentice Base Wage	Health	Pension	Supplemental Unemployment	Total Rate
1	50	\$24.54	\$9.40	\$23.12	\$0.00	\$57.06
2	60	\$29.44	\$9.40	\$23.12	\$0.00	\$61.96
3	70	\$34.35	\$9.40	\$23.12	\$0.00	\$66.87
4	75	\$36.80	\$9.40	\$23.12	\$0.00	\$69.32
5	80	\$39.26	\$9.40	\$23.12	\$0.00	\$71.78
6	80	\$39.26	\$9.40	\$23.12	\$0.00	\$71.78
7	90	\$44.16	\$9.40	\$23.12	\$0.00	\$76.68
8	90	\$44.16	\$9.40	\$23.12	\$0.00	\$76.68

Notes:

% Indentured After 10/1/17; 45/45/55/55/70/70/80/80
 Step 1&2 \$34.01/ 3&4 \$41.46/ 5&6 \$62.80/ 7&8 \$69.25

Apprentice to Journeyworker Ratio:1:5

PIPEFITTER & STEAMFITTER	09/01/2020	\$56.44	\$11.70	\$20.24	\$0.00	\$88.38
PIPEFITTERS LOCAL 537	03/01/2021	\$57.94	\$11.70	\$20.24	\$0.00	\$89.88

Apprentice - PIPEFITTER - Local 537

Effective Date - 09/01/2020

Step	percent	Apprentice Base Wage	Health	Pension	Supplemental Unemployment	Total Rate
1	40	\$22.58	\$11.70	\$8.25	\$0.00	\$42.53
2	45	\$25.40	\$11.70	\$20.24	\$0.00	\$57.34
3	60	\$33.86	\$11.70	\$20.24	\$0.00	\$65.80
4	70	\$39.51	\$11.70	\$20.24	\$0.00	\$71.45
5	80	\$45.15	\$11.70	\$20.24	\$0.00	\$77.09

Effective Date - 03/01/2021

Step	percent	Apprentice Base Wage	Health	Pension	Supplemental Unemployment	Total Rate
1	40	\$23.18	\$11.70	\$8.25	\$0.00	\$43.13
2	45	\$26.07	\$11.70	\$20.24	\$0.00	\$58.01
3	60	\$34.76	\$11.70	\$20.24	\$0.00	\$66.70
4	70	\$40.56	\$11.70	\$20.24	\$0.00	\$72.50
5	80	\$46.35	\$11.70	\$20.24	\$0.00	\$78.29

Notes:

** 1:3; 3:15; 1:10 thereafter / Steps are 1 yr.
 Refrig/AC Mechanic **1:1;1:2;2:4;3:6;4:8;5:10;6:12;7:14;8:17;9:20;10:23(Max)

Apprentice to Journeyworker Ratio:**

Classification	Effective Date	Base Wage	Health	Pension	Supplemental Unemployment	Total Rate
PIPELAYER <i>LABORERS - ZONE 1</i>	12/01/2020	\$40.15	\$8.60	\$17.32	\$0.00	\$66.07
	06/01/2021	\$41.17	\$8.60	\$17.32	\$0.00	\$67.09
	12/01/2021	\$42.18	\$8.60	\$17.32	\$0.00	\$68.10
	06/01/2022	\$43.18	\$8.60	\$17.32	\$0.00	\$69.10
	12/01/2022	\$44.18	\$8.60	\$17.32	\$0.00	\$70.10
	06/01/2023	\$45.18	\$8.60	\$17.32	\$0.00	\$71.10
	12/01/2023	\$46.43	\$8.60	\$17.32	\$0.00	\$72.35
For apprentice rates see "Apprentice- LABORER"						
PIPELAYER (HEAVY & HIGHWAY) <i>LABORERS - ZONE 1 (HEAVY & HIGHWAY)</i>	12/01/2020	\$40.15	\$8.60	\$17.32	\$0.00	\$66.07
	06/01/2021	\$41.17	\$8.60	\$17.32	\$0.00	\$67.09
	12/01/2021	\$42.18	\$8.60	\$17.32	\$0.00	\$68.10
For apprentice rates see "Apprentice- LABORER (Heavy and Highway)"						
PLUMBERS & GASFITTERS <i>PLUMBERS & GASFITTERS LOCAL 12</i>	09/01/2020	\$58.69	\$13.57	\$17.26	\$0.00	\$89.52
	03/01/2021	\$60.19	\$13.57	\$17.26	\$0.00	\$91.02

Apprentice - PLUMBER/GASFITTER - Local 12

Effective Date - 09/01/2020

Step	percent	Apprentice Base Wage	Health	Pension	Supplemental Unemployment	Total Rate
1	35	\$20.54	\$13.57	\$6.24	\$0.00	\$40.35
2	40	\$23.48	\$13.57	\$7.08	\$0.00	\$44.13
3	55	\$32.28	\$13.57	\$9.63	\$0.00	\$55.48
4	65	\$38.15	\$13.57	\$11.33	\$0.00	\$63.05
5	75	\$44.02	\$13.57	\$13.03	\$0.00	\$70.62

Effective Date - 03/01/2021

Step	percent	Apprentice Base Wage	Health	Pension	Supplemental Unemployment	Total Rate
1	35	\$21.07	\$13.57	\$6.24	\$0.00	\$40.88
2	40	\$24.08	\$13.57	\$7.08	\$0.00	\$44.73
3	55	\$33.10	\$13.57	\$9.63	\$0.00	\$56.30
4	65	\$39.12	\$13.57	\$11.33	\$0.00	\$64.02
5	75	\$45.14	\$13.57	\$13.03	\$0.00	\$71.74

Notes:

** 1:2; 2:6; 3:10; 4:14; 5:19/Steps are 1 yr
Step4 with lic\$66.82, Step5 with lic\$74.39

Apprentice to Journeyworker Ratio:**

PNEUMATIC CONTROLS (TEMP.) <i>PIPEFITTERS LOCAL 537</i>	09/01/2020	\$56.44	\$11.70	\$20.24	\$0.00	\$88.38
	03/01/2021	\$57.94	\$11.70	\$20.24	\$0.00	\$89.88
For apprentice rates see "Apprentice- PIPEFITTER" or "PLUMBER/PIPEFITTER"						
PNEUMATIC DRILL/TOOL OPERATOR <i>LABORERS - ZONE 1</i>	12/01/2020	\$40.15	\$8.60	\$17.32	\$0.00	\$66.07
	06/01/2021	\$41.17	\$8.60	\$17.32	\$0.00	\$67.09
	12/01/2021	\$42.18	\$8.60	\$17.32	\$0.00	\$68.10
	06/01/2022	\$43.18	\$8.60	\$17.32	\$0.00	\$69.10
	12/01/2022	\$44.18	\$8.60	\$17.32	\$0.00	\$70.10
	06/01/2023	\$45.18	\$8.60	\$17.32	\$0.00	\$71.10
	12/01/2023	\$46.43	\$8.60	\$17.32	\$0.00	\$72.35

Classification	Effective Date	Base Wage	Health	Pension	Supplemental Unemployment	Total Rate
For apprentice rates see "Apprentice- LABORER"						
PNEUMATIC DRILL/TOOL OPERATOR (HEAVY & HIGHWAY)	12/01/2020	\$40.15	\$8.60	\$17.32	\$0.00	\$66.07
<i>LABORERS - ZONE 1 (HEAVY & HIGHWAY)</i>	06/01/2021	\$41.17	\$8.60	\$17.32	\$0.00	\$67.09
	12/01/2021	\$42.18	\$8.60	\$17.32	\$0.00	\$68.10
For apprentice rates see "Apprentice- LABORER (Heavy and Highway)"						
POWDERMAN & BLASTER	12/01/2020	\$40.90	\$8.60	\$17.32	\$0.00	\$66.82
<i>LABORERS - ZONE 1</i>	06/01/2021	\$41.92	\$8.60	\$17.32	\$0.00	\$67.84
	12/01/2021	\$42.93	\$8.60	\$17.32	\$0.00	\$68.85
	06/01/2022	\$43.93	\$8.60	\$17.32	\$0.00	\$69.85
	12/01/2022	\$44.93	\$8.60	\$17.32	\$0.00	\$70.85
	06/01/2023	\$45.93	\$8.60	\$17.32	\$0.00	\$71.85
	12/01/2023	\$47.18	\$8.60	\$17.32	\$0.00	\$73.10
For apprentice rates see "Apprentice- LABORER"						
POWDERMAN & BLASTER (HEAVY & HIGHWAY)	12/01/2020	\$40.90	\$8.60	\$17.32	\$0.00	\$66.82
<i>LABORERS - ZONE 1 (HEAVY & HIGHWAY)</i>	06/01/2021	\$41.92	\$8.60	\$17.32	\$0.00	\$67.84
	12/01/2021	\$42.93	\$8.60	\$17.32	\$0.00	\$68.85
For apprentice rates see "Apprentice- LABORER (Heavy and Highway)"						
POWER SHOVEL/DERRICK/TRENCHING MACHINE	12/01/2020	\$49.98	\$13.50	\$15.70	\$0.00	\$79.18
<i>OPERATING ENGINEERS LOCAL 4</i>	06/01/2021	\$51.08	\$13.50	\$15.70	\$0.00	\$80.28
	12/01/2021	\$52.23	\$13.50	\$15.70	\$0.00	\$81.43
For apprentice rates see "Apprentice- OPERATING ENGINEERS"						
PUMP OPERATOR (CONCRETE)	12/01/2020	\$49.98	\$13.50	\$15.70	\$0.00	\$79.18
<i>OPERATING ENGINEERS LOCAL 4</i>	06/01/2021	\$51.08	\$13.50	\$15.70	\$0.00	\$80.28
	12/01/2021	\$52.23	\$13.50	\$15.70	\$0.00	\$81.43
For apprentice rates see "Apprentice- OPERATING ENGINEERS"						
PUMP OPERATOR (DEWATERING, OTHER)	12/01/2020	\$33.00	\$13.50	\$15.70	\$0.00	\$62.20
<i>OPERATING ENGINEERS LOCAL 4</i>	06/01/2021	\$33.75	\$13.50	\$15.70	\$0.00	\$62.95
	12/01/2021	\$34.54	\$13.50	\$15.70	\$0.00	\$63.74
For apprentice rates see "Apprentice- OPERATING ENGINEERS"						
READY-MIX CONCRETE DRIVER	01/01/2021	\$23.50	\$11.51	\$8.00	\$0.00	\$43.01
<i>TEAMSTERS 170 - Rosenfeld (Walpole)</i>						
RECLAIMERS	12/01/2020	\$49.45	\$13.50	\$15.70	\$0.00	\$78.65
<i>OPERATING ENGINEERS LOCAL 4</i>	06/01/2021	\$50.54	\$13.50	\$15.70	\$0.00	\$79.74
	12/01/2021	\$51.68	\$13.50	\$15.70	\$0.00	\$80.88
For apprentice rates see "Apprentice- OPERATING ENGINEERS"						
RIDE-ON MOTORIZED BUGGY OPERATOR	12/01/2020	\$40.15	\$8.60	\$17.32	\$0.00	\$66.07
<i>LABORERS - ZONE 1</i>	06/01/2021	\$41.17	\$8.60	\$17.32	\$0.00	\$67.09
	12/01/2021	\$42.18	\$8.60	\$17.32	\$0.00	\$68.10
	06/01/2022	\$43.18	\$8.60	\$17.32	\$0.00	\$69.10
	12/01/2022	\$44.18	\$8.60	\$17.32	\$0.00	\$70.10
	06/01/2023	\$45.18	\$8.60	\$17.32	\$0.00	\$71.10
	12/01/2023	\$46.43	\$8.60	\$17.32	\$0.00	\$72.35
For apprentice rates see "Apprentice- LABORER"						
ROLLER/SPREADER/MULCHING MACHINE	12/01/2020	\$49.45	\$13.50	\$15.70	\$0.00	\$78.65
<i>OPERATING ENGINEERS LOCAL 4</i>	06/01/2021	\$50.54	\$13.50	\$15.70	\$0.00	\$79.74
	12/01/2021	\$51.68	\$13.50	\$15.70	\$0.00	\$80.88
For apprentice rates see "Apprentice- OPERATING ENGINEERS"						

Classification	Effective Date	Base Wage	Health	Pension	Supplemental Unemployment	Total Rate
ROOFER (Inc.Roofing Waterproofing &Roofing Damproofg) ROOFERS LOCAL 33	08/01/2020	\$46.60	\$11.75	\$16.15	\$0.00	\$74.50
	02/01/2021	\$48.03	\$11.75	\$16.15	\$0.00	\$75.93
	08/01/2021	\$49.46	\$11.75	\$16.15	\$0.00	\$77.36
	02/01/2022	\$50.89	\$11.75	\$16.15	\$0.00	\$78.79

Apprentice - ROOFER - Local 33

Effective Date - 08/01/2020

Step	percent	Apprentice Base Wage	Health	Pension	Supplemental Unemployment	Total Rate
1	50	\$23.30	\$11.75	\$3.81	\$0.00	\$38.86
2	60	\$27.96	\$11.75	\$16.15	\$0.00	\$55.86
3	65	\$30.29	\$11.75	\$16.15	\$0.00	\$58.19
4	75	\$34.95	\$11.75	\$16.15	\$0.00	\$62.85
5	85	\$39.61	\$11.75	\$16.15	\$0.00	\$67.51

Effective Date - 02/01/2021

Step	percent	Apprentice Base Wage	Health	Pension	Supplemental Unemployment	Total Rate
1	50	\$24.02	\$11.75	\$3.81	\$0.00	\$39.58
2	60	\$28.82	\$11.75	\$16.15	\$0.00	\$56.72
3	65	\$31.22	\$11.75	\$16.15	\$0.00	\$59.12
4	75	\$36.02	\$11.75	\$16.15	\$0.00	\$63.92
5	85	\$40.83	\$11.75	\$16.15	\$0.00	\$68.73

Notes: ** 1:5, 2:6-10, the 1:10; Reroofing: 1:4, then 1:1
 Step 1 is 2000 hrs.; Steps 2-5 are 1000 hrs.
 (Hot Pitch Mechanics' receive \$1.00 hr. above ROOFER)

Apprentice to Journeyworker Ratio:**

ROOFER SLATE / TILE / PRECAST CONCRETE ROOFERS LOCAL 33	08/01/2020	\$46.85	\$11.75	\$16.15	\$0.00	\$74.75
	02/01/2021	\$48.28	\$11.75	\$16.15	\$0.00	\$76.18
	08/01/2021	\$49.71	\$11.75	\$16.15	\$0.00	\$77.61
	02/01/2022	\$51.14	\$11.75	\$16.15	\$0.00	\$79.04

For apprentice rates see "Apprentice- ROOFER"

SHEETMETAL WORKER SHEETMETAL WORKERS LOCAL 17 - A	08/01/2020	\$50.67	\$13.50	\$24.12	\$2.65	\$90.94
	02/01/2021	\$52.32	\$13.50	\$24.12	\$2.70	\$92.64
	08/01/2021	\$54.07	\$13.50	\$24.12	\$2.75	\$94.44
	02/01/2022	\$55.82	\$13.50	\$24.12	\$2.80	\$96.24

Classification

Effective Date Base Wage Health Pension Supplemental Unemployment Total Rate

Apprentice - SHEET METAL WORKER - Local 17-A

Effective Date - 08/01/2020

Step	percent	Apprentice Base Wage	Health	Pension	Supplemental Unemployment	Total Rate
1	42	\$21.28	\$13.50	\$5.89	\$0.00	\$40.67
2	42	\$21.28	\$13.50	\$5.89	\$0.00	\$40.67
3	47	\$23.81	\$13.50	\$11.13	\$1.45	\$49.89
4	47	\$23.81	\$13.50	\$11.13	\$1.45	\$49.89
5	52	\$26.35	\$13.50	\$12.08	\$1.56	\$53.49
6	52	\$26.35	\$13.50	\$12.33	\$1.57	\$53.75
7	60	\$30.40	\$13.50	\$13.70	\$1.73	\$59.33
8	65	\$32.94	\$13.50	\$15.15	\$1.83	\$63.42
9	75	\$38.00	\$13.50	\$16.56	\$2.04	\$70.10
10	85	\$43.07	\$13.50	\$17.96	\$2.24	\$76.77

Effective Date - 02/01/2021

Step	percent	Apprentice Base Wage	Health	Pension	Supplemental Unemployment	Total Rate
1	42	\$21.97	\$13.50	\$5.89	\$0.00	\$41.36
2	42	\$21.97	\$13.50	\$5.89	\$0.00	\$41.36
3	47	\$24.59	\$13.50	\$11.13	\$1.48	\$50.70
4	47	\$24.59	\$13.50	\$11.13	\$1.48	\$50.70
5	52	\$27.21	\$13.50	\$12.08	\$1.58	\$54.37
6	52	\$27.21	\$13.50	\$12.33	\$1.59	\$54.63
7	60	\$31.39	\$13.50	\$13.70	\$1.76	\$60.35
8	65	\$34.01	\$13.50	\$15.15	\$1.88	\$64.54
9	75	\$39.24	\$13.50	\$16.56	\$2.08	\$71.38
10	85	\$44.47	\$13.50	\$17.96	\$2.28	\$78.21

Notes:
Steps are 6 mos.

Apprentice to Journeyworker Ratio:1:4

SPECIALIZED EARTH MOVING EQUIP < 35 TONS <i>TEAMSTERS JOINT COUNCIL NO. 10 ZONE A</i>	12/01/2020	\$36.54	\$12.91	\$14.82	\$0.00	\$64.27
	06/01/2021	\$37.34	\$12.91	\$14.82	\$0.00	\$65.07
	08/01/2021	\$37.34	\$13.41	\$14.82	\$0.00	\$65.57
	12/01/2021	\$37.34	\$13.41	\$16.01	\$0.00	\$66.76
SPECIALIZED EARTH MOVING EQUIP > 35 TONS <i>TEAMSTERS JOINT COUNCIL NO. 10 ZONE A</i>	12/01/2020	\$36.83	\$12.91	\$14.82	\$0.00	\$64.56
	06/01/2021	\$37.63	\$12.91	\$14.82	\$0.00	\$65.36
	08/01/2021	\$37.63	\$13.41	\$14.82	\$0.00	\$65.86
	12/01/2021	\$37.63	\$13.41	\$16.01	\$0.00	\$67.05
SPRINKLER FITTER <i>SPRINKLER FITTERS LOCAL 550 - (Section A) Zone 1</i>	01/01/2021	\$61.45	\$10.00	\$20.75	\$0.00	\$92.20
	03/01/2021	\$63.47	\$10.00	\$20.75	\$0.00	\$94.22

Classification

Effective Date Base Wage Health Pension Supplemental Unemployment Total Rate

Apprentice - SPRINKLER FITTER - Local 550 (Section A) Zone 1

Effective Date - 01/01/2021

Step	percent	Apprentice Base Wage	Health	Pension	Supplemental Unemployment	Total Rate
1	35	\$21.51	\$10.00	\$11.81	\$0.00	\$43.32
2	40	\$24.58	\$10.00	\$12.50	\$0.00	\$47.08
3	45	\$27.65	\$10.00	\$13.19	\$0.00	\$50.84
4	50	\$30.73	\$10.00	\$13.93	\$0.00	\$54.66
5	55	\$33.80	\$10.00	\$14.56	\$0.00	\$58.36
6	60	\$36.87	\$10.00	\$15.25	\$0.00	\$62.12
7	65	\$39.94	\$10.00	\$15.94	\$0.00	\$65.88
8	70	\$43.02	\$10.00	\$16.63	\$0.00	\$69.65
9	75	\$46.09	\$10.00	\$17.31	\$0.00	\$73.40
10	80	\$49.16	\$10.00	\$18.00	\$0.00	\$77.16

Effective Date - 03/01/2021

Step	percent	Apprentice Base Wage	Health	Pension	Supplemental Unemployment	Total Rate
1	35	\$22.21	\$10.00	\$11.81	\$0.00	\$44.02
2	40	\$25.39	\$10.00	\$12.50	\$0.00	\$47.89
3	45	\$28.56	\$10.00	\$13.19	\$0.00	\$51.75
4	50	\$31.74	\$10.00	\$13.93	\$0.00	\$55.67
5	55	\$34.91	\$10.00	\$14.56	\$0.00	\$59.47
6	60	\$38.08	\$10.00	\$15.25	\$0.00	\$63.33
7	65	\$41.26	\$10.00	\$15.94	\$0.00	\$67.20
8	70	\$44.43	\$10.00	\$16.63	\$0.00	\$71.06
9	75	\$47.60	\$10.00	\$17.31	\$0.00	\$74.91
10	80	\$50.78	\$10.00	\$18.00	\$0.00	\$78.78

Notes: Apprentice entered prior 9/30/10:
40/45/50/55/60/65/70/75/80/85
Steps are 850 hours

Apprentice to Journeyworker Ratio:1:3

STEAM BOILER OPERATOR <i>OPERATING ENGINEERS LOCAL 4</i>	12/01/2020	\$49.45	\$13.50	\$15.70	\$0.00	\$78.65
	06/01/2021	\$50.54	\$13.50	\$15.70	\$0.00	\$79.74
	12/01/2021	\$51.68	\$13.50	\$15.70	\$0.00	\$80.88

For apprentice rates see "Apprentice- OPERATING ENGINEERS"

TAMPERS, SELF-PROPELLED OR TRACTOR DRAWN <i>OPERATING ENGINEERS LOCAL 4</i>	12/01/2020	\$49.45	\$13.50	\$15.70	\$0.00	\$78.65
	06/01/2021	\$50.54	\$13.50	\$15.70	\$0.00	\$79.74
	12/01/2021	\$51.68	\$13.50	\$15.70	\$0.00	\$80.88

For apprentice rates see "Apprentice- OPERATING ENGINEERS"

TELECOMMUNICATION TECHNICIAN <i>ELECTRICIANS LOCAL 103</i>	09/01/2020	\$40.84	\$13.00	\$17.53	\$0.00	\$71.37
	03/01/2021	\$42.11	\$13.00	\$17.88	\$0.00	\$72.99
	09/01/2021	\$43.77	\$13.00	\$18.00	\$0.00	\$74.77
	03/01/2022	\$45.27	\$13.00	\$18.12	\$0.00	\$76.39
	09/01/2022	\$46.99	\$13.00	\$18.24	\$0.00	\$78.23
	03/01/2023	\$48.54	\$13.00	\$18.37	\$0.00	\$79.91

Apprentice - TELECOMMUNICATION TECHNICIAN - Local 103

Effective Date - 09/01/2020

Step	percent	Apprentice Base Wage	Health	Pension	Supplemental Unemployment	Total Rate
1	45	\$18.38	\$13.00	\$0.55	\$0.00	\$31.93
2	45	\$18.38	\$13.00	\$0.55	\$0.00	\$31.93
3	50	\$20.42	\$13.00	\$14.20	\$0.00	\$47.62
4	50	\$20.42	\$13.00	\$14.20	\$0.00	\$47.62
5	55	\$22.46	\$13.00	\$14.53	\$0.00	\$49.99
6	60	\$24.50	\$13.00	\$14.87	\$0.00	\$52.37
7	65	\$26.55	\$13.00	\$15.20	\$0.00	\$54.75
8	70	\$28.59	\$13.00	\$15.53	\$0.00	\$57.12
9	75	\$30.63	\$13.00	\$15.87	\$0.00	\$59.50
10	80	\$32.67	\$13.00	\$16.20	\$0.00	\$61.87

Effective Date - 03/01/2021

Step	percent	Apprentice Base Wage	Health	Pension	Supplemental Unemployment	Total Rate
1	45	\$18.95	\$13.00	\$0.57	\$0.00	\$32.52
2	45	\$18.95	\$13.00	\$0.57	\$0.00	\$32.52
3	50	\$21.06	\$13.00	\$14.47	\$0.00	\$48.53
4	50	\$21.06	\$13.00	\$14.47	\$0.00	\$48.53
5	55	\$23.16	\$13.00	\$14.80	\$0.00	\$50.96
6	60	\$25.27	\$13.00	\$15.14	\$0.00	\$53.41
7	65	\$27.37	\$13.00	\$15.47	\$0.00	\$55.84
8	70	\$29.48	\$13.00	\$15.80	\$0.00	\$58.28
9	75	\$31.58	\$13.00	\$16.15	\$0.00	\$60.73
10	80	\$33.69	\$13.00	\$16.48	\$0.00	\$63.17

Notes:

Apprentice to Journeyworker Ratio:1:1

TERRAZZO FINISHERS	08/01/2020	\$54.69	\$10.75	\$22.09	\$0.00	\$87.53
BRICKLAYERS LOCAL 3 - MARBLE & TILE	02/01/2021	\$55.33	\$10.75	\$22.09	\$0.00	\$88.17
	08/01/2021	\$56.73	\$10.75	\$22.25	\$0.00	\$89.73
	02/01/2022	\$57.32	\$10.75	\$22.25	\$0.00	\$90.32

Apprentice - TERRAZZO FINISHER - Local 3 Marble & Tile

Effective Date - 08/01/2020

Step	percent	Apprentice Base Wage	Health	Pension	Supplemental Unemployment	Total Rate
1	50	\$27.35	\$10.75	\$22.09	\$0.00	\$60.19
2	60	\$32.81	\$10.75	\$22.09	\$0.00	\$65.65
3	70	\$38.28	\$10.75	\$22.09	\$0.00	\$71.12
4	80	\$43.75	\$10.75	\$22.09	\$0.00	\$76.59
5	90	\$49.22	\$10.75	\$22.09	\$0.00	\$82.06

Effective Date - 02/01/2021

Step	percent	Apprentice Base Wage	Health	Pension	Supplemental Unemployment	Total Rate
1	50	\$27.67	\$10.75	\$22.09	\$0.00	\$60.51
2	60	\$33.20	\$10.75	\$22.09	\$0.00	\$66.04
3	70	\$38.73	\$10.75	\$22.09	\$0.00	\$71.57
4	80	\$44.26	\$10.75	\$22.09	\$0.00	\$77.10
5	90	\$49.80	\$10.75	\$22.09	\$0.00	\$82.64

Notes:

Apprentice to Journeyworker Ratio:1:3

TEST BORING DRILLER <i>LABORERS - FOUNDATION AND MARINE</i>	12/01/2020	\$41.30	\$8.60	\$17.47	\$0.00	\$67.37
	06/01/2021	\$42.32	\$8.60	\$17.47	\$0.00	\$68.39
	12/01/2021	\$43.33	\$8.60	\$17.47	\$0.00	\$69.40

For apprentice rates see "Apprentice- LABORER"

TEST BORING DRILLER HELPER <i>LABORERS - FOUNDATION AND MARINE</i>	12/01/2020	\$40.02	\$8.60	\$17.47	\$0.00	\$66.09
	06/01/2021	\$41.04	\$8.60	\$17.47	\$0.00	\$67.11
	12/01/2021	\$42.05	\$8.60	\$17.47	\$0.00	\$68.12

For apprentice rates see "Apprentice- LABORER"

TEST BORING LABORER <i>LABORERS - FOUNDATION AND MARINE</i>	12/01/2020	\$39.90	\$8.60	\$17.47	\$0.00	\$65.97
	06/01/2021	\$40.92	\$8.60	\$17.47	\$0.00	\$66.99
	12/01/2021	\$41.93	\$8.60	\$17.47	\$0.00	\$68.00

For apprentice rates see "Apprentice- LABORER"

TRACTORS/PORTABLE STEAM GENERATORS <i>OPERATING ENGINEERS LOCAL 4</i>	12/01/2020	\$49.45	\$13.50	\$15.70	\$0.00	\$78.65
	06/01/2021	\$50.54	\$13.50	\$15.70	\$0.00	\$79.74
	12/01/2021	\$51.68	\$13.50	\$15.70	\$0.00	\$80.88

For apprentice rates see "Apprentice- OPERATING ENGINEERS"

TRAILERS FOR EARTH MOVING EQUIPMENT <i>TEAMSTERS JOINT COUNCIL NO. 10 ZONE A</i>	12/01/2020	\$37.12	\$12.91	\$14.82	\$0.00	\$64.85
	06/01/2021	\$37.92	\$12.91	\$14.82	\$0.00	\$65.65
	08/01/2021	\$37.92	\$13.41	\$14.82	\$0.00	\$66.15
	12/01/2021	\$37.92	\$13.41	\$16.01	\$0.00	\$67.34

TUNNEL WORK - COMPRESSED AIR <i>LABORERS (COMPRESSED AIR)</i>	12/01/2020	\$52.13	\$8.60	\$17.92	\$0.00	\$78.65
	06/01/2021	\$53.15	\$8.60	\$17.92	\$0.00	\$79.67
	12/01/2021	\$54.16	\$8.60	\$17.92	\$0.00	\$80.68

For apprentice rates see "Apprentice- LABORER"

Classification	Effective Date	Base Wage	Health	Pension	Supplemental Unemployment	Total Rate
TUNNEL WORK - COMPRESSED AIR (HAZ. WASTE) <i>LABORERS (COMPRESSED AIR)</i>	12/01/2020	\$54.13	\$8.60	\$17.92	\$0.00	\$80.65
	06/01/2021	\$55.15	\$8.60	\$17.92	\$0.00	\$81.67
	12/01/2021	\$56.16	\$8.60	\$17.92	\$0.00	\$82.68
For apprentice rates see "Apprentice- LABORER"						
TUNNEL WORK - FREE AIR <i>LABORERS (FREE AIR TUNNEL)</i>	12/01/2020	\$44.20	\$8.60	\$17.92	\$0.00	\$70.72
	06/01/2021	\$45.22	\$8.60	\$17.92	\$0.00	\$71.74
	12/01/2021	\$46.23	\$8.60	\$17.92	\$0.00	\$72.75
For apprentice rates see "Apprentice- LABORER"						
TUNNEL WORK - FREE AIR (HAZ. WASTE) <i>LABORERS (FREE AIR TUNNEL)</i>	12/01/2020	\$46.20	\$8.60	\$17.92	\$0.00	\$72.72
	06/01/2021	\$47.22	\$8.60	\$17.92	\$0.00	\$73.74
	12/01/2021	\$48.23	\$8.60	\$17.92	\$0.00	\$74.75
For apprentice rates see "Apprentice- LABORER"						
VAC-HAUL <i>TEAMSTERS JOINT COUNCIL NO. 10 ZONE A</i>	12/01/2020	\$36.54	\$12.91	\$14.82	\$0.00	\$64.27
	06/01/2021	\$37.34	\$12.91	\$14.82	\$0.00	\$65.07
	08/01/2021	\$37.34	\$13.41	\$14.82	\$0.00	\$65.57
	12/01/2021	\$37.34	\$13.41	\$16.01	\$0.00	\$66.76
WAGON DRILL OPERATOR <i>LABORERS - ZONE 1</i>	12/01/2020	\$40.15	\$8.60	\$17.32	\$0.00	\$66.07
	06/01/2021	\$41.17	\$8.60	\$17.32	\$0.00	\$67.09
	12/01/2021	\$42.18	\$8.60	\$17.32	\$0.00	\$68.10
	06/01/2022	\$43.18	\$8.60	\$17.32	\$0.00	\$69.10
	12/01/2022	\$44.18	\$8.60	\$17.32	\$0.00	\$70.10
	06/01/2023	\$45.18	\$8.60	\$17.32	\$0.00	\$71.10
	12/01/2023	\$46.43	\$8.60	\$17.32	\$0.00	\$72.35
For apprentice rates see "Apprentice- LABORER"						
WAGON DRILL OPERATOR (HEAVY & HIGHWAY) <i>LABORERS - ZONE 1 (HEAVY & HIGHWAY)</i>	12/01/2020	\$40.15	\$8.60	\$17.32	\$0.00	\$66.07
	06/01/2021	\$41.17	\$8.60	\$17.32	\$0.00	\$67.09
	12/01/2021	\$42.18	\$8.60	\$17.32	\$0.00	\$68.10
For apprentice rates see "Apprentice- LABORER (Heavy and Highway)"						
WASTE WATER PUMP OPERATOR <i>OPERATING ENGINEERS LOCAL 4</i>	12/01/2020	\$49.98	\$13.50	\$15.70	\$0.00	\$79.18
	06/01/2021	\$51.08	\$13.50	\$15.70	\$0.00	\$80.28
	12/01/2021	\$52.23	\$13.50	\$15.70	\$0.00	\$81.43
For apprentice rates see "Apprentice- OPERATING ENGINEERS"						
WATER METER INSTALLER <i>PLUMBERS & GASFITTERS LOCAL 12</i>	09/01/2020	\$58.69	\$13.57	\$17.26	\$0.00	\$89.52
	03/01/2021	\$60.19	\$13.57	\$17.26	\$0.00	\$91.02
For apprentice rates see "Apprentice- PLUMBER/PIPEFITTER" or "PLUMBER/GASFITTER"						
Rental of Equipment - East						
(2 AXLE) DRIVER - EQUIPMENT <i>TEAMSTERS JOINT COUNCIL NO. 10 ZONE A</i>	12/01/2020	\$36.25	\$12.91	\$0.00	\$0.00	\$49.16
	06/01/2021	\$37.05	\$12.91	\$0.00	\$0.00	\$49.96
	08/01/2021	\$37.05	\$13.41	\$0.00	\$0.00	\$50.46
	12/01/2021	\$37.05	\$13.41	\$0.00	\$0.00	\$50.46
(3 AXLE) DRIVER - EQUIPMENT <i>TEAMSTERS JOINT COUNCIL NO. 10 ZONE A</i>	12/01/2020	\$36.32	\$12.91	\$0.00	\$0.00	\$49.23
	06/01/2021	\$37.12	\$12.91	\$0.00	\$0.00	\$50.03
	08/01/2021	\$37.12	\$13.41	\$0.00	\$0.00	\$50.53
	12/01/2021	\$37.12	\$13.41	\$0.00	\$0.00	\$50.53

Classification	Effective Date	Base Wage	Health	Pension	Supplemental Unemployment	Total Rate
(4 & 5 AXLE) DRIVER - EQUIPMENT <i>TEAMSTERS JOINT COUNCIL NO. 10 ZONE A</i>	12/01/2020	\$36.44	\$12.91	\$0.00	\$0.00	\$49.35
	06/01/2021	\$37.24	\$12.91	\$0.00	\$0.00	\$50.15
	08/01/2021	\$37.24	\$13.41	\$0.00	\$0.00	\$50.65
	12/01/2021	\$37.24	\$13.41	\$0.00	\$0.00	\$50.65
ADS/SUBMERSIBLE PILOT <i>PILE DRIVER LOCAL 56 (ZONE 1)</i>	08/01/2020	\$103.05	\$9.40	\$0.00	\$0.00	\$112.45
For apprentice rates see "Apprentice- PILE DRIVER"						
ASPHALT/CONCRETE/CRUSHER PLANT-ON SITE <i>OPERATING ENGINEERS LOCAL 4</i>	12/01/2020	\$49.98	\$13.50	\$0.00	\$0.00	\$63.48
	06/01/2021	\$51.08	\$13.50	\$0.00	\$0.00	\$64.58
	12/01/2021	\$52.23	\$13.50	\$0.00	\$0.00	\$65.73
For apprentice rates see "Apprentice- OPERATING ENGINEERS"						
BACKHOE/FRONT-END LOADER <i>OPERATING ENGINEERS LOCAL 4</i>	12/01/2020	\$49.98	\$13.50	\$0.00	\$0.00	\$63.48
	06/01/2021	\$51.08	\$13.50	\$0.00	\$0.00	\$64.58
	12/01/2021	\$52.23	\$13.50	\$0.00	\$0.00	\$65.73
For apprentice rates see "Apprentice- OPERATING ENGINEERS"						
BULLDOZER/GRADER/SCRAPER <i>OPERATING ENGINEERS LOCAL 4</i>	12/01/2020	\$49.45	\$13.50	\$0.00	\$0.00	\$62.95
	06/01/2021	\$50.54	\$13.50	\$0.00	\$0.00	\$64.04
	12/01/2021	\$51.68	\$13.50	\$0.00	\$0.00	\$65.18
For apprentice rates see "Apprentice- OPERATING ENGINEERS"						
CLAM SHELLS/SLURRY BUCKETS/HEADING MACHINES <i>OPERATING ENGINEERS LOCAL 4</i>	12/01/2020	\$50.98	\$13.50	\$0.00	\$0.00	\$64.48
	06/01/2021	\$52.08	\$13.50	\$0.00	\$0.00	\$65.58
	12/01/2021	\$53.23	\$13.50	\$0.00	\$0.00	\$66.73
For apprentice rates see "Apprentice- OPERATING ENGINEERS"						
COMPRESSOR OPERATOR <i>OPERATING ENGINEERS LOCAL 4</i>	12/01/2020	\$33.00	\$13.50	\$0.00	\$0.00	\$46.50
	06/01/2021	\$33.75	\$13.50	\$0.00	\$0.00	\$47.25
	12/01/2021	\$34.54	\$13.50	\$0.00	\$0.00	\$48.04
For apprentice rates see "Apprentice- OPERATING ENGINEERS"						
DIVER <i>PILE DRIVER LOCAL 56 (ZONE 1)</i>	08/01/2020	\$68.70	\$9.40	\$0.00	\$0.00	\$78.10
For apprentice rates see "Apprentice- PILE DRIVER"						
DIVER TENDER <i>PILE DRIVER LOCAL 56 (ZONE 1)</i>	08/01/2020	\$49.07	\$9.40	\$0.00	\$0.00	\$58.47
For apprentice rates see "Apprentice- PILE DRIVER"						
DIVER TENDER (EFFLUENT) <i>PILE DRIVER LOCAL 56 (ZONE 1)</i>	08/01/2020	\$73.60	\$9.40	\$0.00	\$0.00	\$83.00
For apprentice rates see "Apprentice- PILE DRIVER"						
DIVER/SLURRY (EFFLUENT) <i>PILE DRIVER LOCAL 56 (ZONE 1)</i>	08/01/2020	\$103.05	\$9.40	\$0.00	\$0.00	\$112.45
For apprentice rates see "Apprentice- PILE DRIVER"						
FORK LIFT/CHERRY PICKER <i>OPERATING ENGINEERS LOCAL 4</i>	12/01/2020	\$49.98	\$13.50	\$0.00	\$0.00	\$63.48
	06/01/2021	\$51.08	\$13.50	\$0.00	\$0.00	\$64.58
	12/01/2021	\$52.23	\$13.50	\$0.00	\$0.00	\$65.73
For apprentice rates see "Apprentice- OPERATING ENGINEERS"						
GENERATOR/LIGHTING PLANT/HEATERS <i>OPERATING ENGINEERS LOCAL 4</i>	12/01/2020	\$33.00	\$13.50	\$0.00	\$0.00	\$46.50
	06/01/2021	\$33.75	\$13.50	\$0.00	\$0.00	\$47.25
	12/01/2021	\$34.54	\$13.50	\$0.00	\$0.00	\$48.04
For apprentice rates see "Apprentice- OPERATING ENGINEERS"						

Classification	Effective Date	Base Wage	Health	Pension	Supplemental Unemployment	Total Rate
HOISTING ENGINEER/CRANES/GRADALLS <i>OPERATING ENGINEERS LOCAL 4</i>	12/01/2020	\$49.98	\$13.50	\$0.00	\$0.00	\$63.48
	06/01/2021	\$51.08	\$13.50	\$0.00	\$0.00	\$64.58
	12/01/2021	\$52.23	\$13.50	\$0.00	\$0.00	\$65.73

Apprentice - OPERATING ENGINEERS - Local 4

Effective Date - 12/01/2020

Step	percent	Apprentice Base Wage	Health	Pension	Supplemental Unemployment	Total Rate
1	55	\$27.49	\$13.50	\$0.00	\$0.00	\$40.99
2	60	\$29.99	\$13.50	\$0.00	\$0.00	\$43.49
3	65	\$32.49	\$13.50	\$0.00	\$0.00	\$45.99
4	70	\$34.99	\$13.50	\$0.00	\$0.00	\$48.49
5	75	\$37.49	\$13.50	\$0.00	\$0.00	\$50.99
6	80	\$39.98	\$13.50	\$0.00	\$0.00	\$53.48
7	85	\$42.48	\$13.50	\$0.00	\$0.00	\$55.98
8	90	\$44.98	\$13.50	\$0.00	\$0.00	\$58.48

Effective Date - 06/01/2021

Step	percent	Apprentice Base Wage	Health	Pension	Supplemental Unemployment	Total Rate
1	55	\$28.09	\$13.50	\$0.00	\$0.00	\$41.59
2	60	\$30.65	\$13.50	\$0.00	\$0.00	\$44.15
3	65	\$33.20	\$13.50	\$0.00	\$0.00	\$46.70
4	70	\$35.76	\$13.50	\$0.00	\$0.00	\$49.26
5	75	\$38.31	\$13.50	\$0.00	\$0.00	\$51.81
6	80	\$40.86	\$13.50	\$0.00	\$0.00	\$54.36
7	85	\$43.42	\$13.50	\$0.00	\$0.00	\$56.92
8	90	\$45.97	\$13.50	\$0.00	\$0.00	\$59.47

Notes:

Apprentice to Journeyworker Ratio:1:6

LABORER <i>LABORERS - ZONE 1</i>	12/01/2020	\$39.90	\$8.60	\$0.00	\$0.00	\$48.50
	06/01/2021	\$40.92	\$8.60	\$0.00	\$0.00	\$49.52
	12/01/2021	\$41.93	\$8.60	\$0.00	\$0.00	\$50.53
	06/01/2022	\$42.93	\$8.60	\$0.00	\$0.00	\$51.53
	12/01/2022	\$43.93	\$8.60	\$0.00	\$0.00	\$52.53
	06/01/2023	\$44.93	\$8.60	\$0.00	\$0.00	\$53.53
	12/01/2023	\$46.18	\$8.60	\$0.00	\$0.00	\$54.78

Apprentice - LABORER - Zone 1

Effective Date - 12/01/2020

Step	percent	Apprentice Base Wage	Health	Pension	Supplemental Unemployment	Total Rate
1	60	\$23.94	\$8.60	\$0.00	\$0.00	\$32.54
2	70	\$27.93	\$8.60	\$0.00	\$0.00	\$36.53
3	80	\$31.92	\$8.60	\$0.00	\$0.00	\$40.52
4	90	\$35.91	\$8.60	\$0.00	\$0.00	\$44.51

Effective Date - 06/01/2021

Step	percent	Apprentice Base Wage	Health	Pension	Supplemental Unemployment	Total Rate
1	60	\$24.55	\$8.60	\$0.00	\$0.00	\$33.15
2	70	\$28.64	\$8.60	\$0.00	\$0.00	\$37.24
3	80	\$32.74	\$8.60	\$0.00	\$0.00	\$41.34
4	90	\$36.83	\$8.60	\$0.00	\$0.00	\$45.43

Notes:

Apprentice to Journeyworker Ratio:1:5

OILER (OTHER THAN TRUCK CRANES,GRADALLS) <i>OPERATING ENGINEERS LOCAL 4</i>	12/01/2020	\$23.20	\$13.50	\$0.00	\$0.00	\$36.70
	06/01/2021	\$23.75	\$13.50	\$0.00	\$0.00	\$37.25
	12/01/2021	\$24.33	\$13.50	\$0.00	\$0.00	\$37.83
For apprentice rates see "Apprentice- OPERATING ENGINEERS"						
OILER (TRUCK CRANES, GRADALLS) <i>OPERATING ENGINEERS LOCAL 4</i>	12/01/2020	\$27.97	\$13.50	\$0.00	\$0.00	\$41.47
	06/01/2021	\$28.61	\$13.50	\$0.00	\$0.00	\$42.11
	12/01/2021	\$29.29	\$13.50	\$0.00	\$0.00	\$42.79
For apprentice rates see "Apprentice- OPERATING ENGINEERS"						
OTHER POWER DRIVEN EQUIPMENT - CLASS II <i>OPERATING ENGINEERS LOCAL 4</i>	12/01/2020	\$49.45	\$13.50	\$0.00	\$0.00	\$62.95
	06/01/2021	\$50.54	\$13.50	\$0.00	\$0.00	\$64.04
	12/01/2021	\$51.68	\$13.50	\$0.00	\$0.00	\$65.18
For apprentice rates see "Apprentice- OPERATING ENGINEERS"						
PANEL & PICKUP TRUCKS DRIVER <i>TEAMSTERS JOINT COUNCIL NO. 10 ZONE A</i>	12/01/2020	\$36.08	\$12.91	\$0.00	\$0.00	\$48.99
	06/01/2021	\$36.88	\$12.91	\$0.00	\$0.00	\$49.79
	08/01/2021	\$36.88	\$13.41	\$0.00	\$0.00	\$50.29
	12/01/2021	\$36.88	\$13.41	\$0.00	\$0.00	\$50.29
POWER SHOVEL/DERRICK/TRENCHING MACHINE <i>OPERATING ENGINEERS LOCAL 4</i>	12/01/2020	\$49.98	\$13.50	\$0.00	\$0.00	\$63.48
	06/01/2021	\$51.08	\$13.50	\$0.00	\$0.00	\$64.58
	12/01/2021	\$52.23	\$13.50	\$0.00	\$0.00	\$65.73
For apprentice rates see "Apprentice- OPERATING ENGINEERS"						
PUMP OPERATOR (CONCRETE) <i>OPERATING ENGINEERS LOCAL 4</i>	12/01/2020	\$49.98	\$13.50	\$0.00	\$0.00	\$63.48
	06/01/2021	\$51.08	\$13.50	\$0.00	\$0.00	\$64.58
	12/01/2021	\$52.23	\$13.50	\$0.00	\$0.00	\$65.73
For apprentice rates see "Apprentice- OPERATING ENGINEERS"						
PUMP OPERATOR (DEWATERING, OTHER) <i>OPERATING ENGINEERS LOCAL 4</i>	12/01/2020	\$33.00	\$13.50	\$0.00	\$0.00	\$46.50
	06/01/2021	\$33.75	\$13.50	\$0.00	\$0.00	\$47.25
	12/01/2021	\$34.54	\$13.50	\$0.00	\$0.00	\$48.04

Classification	Effective Date	Base Wage	Health	Pension	Supplemental Unemployment	Total Rate
For apprentice rates see "Apprentice- OPERATING ENGINEERS"						
ROLLER/SPREADER/MULCHING MACHINE <i>OPERATING ENGINEERS LOCAL 4</i>	12/01/2020	\$49.45	\$13.50	\$0.00	\$0.00	\$62.95
	06/01/2021	\$50.54	\$13.50	\$0.00	\$0.00	\$64.04
	12/01/2021	\$51.68	\$13.50	\$0.00	\$0.00	\$65.18
For apprentice rates see "Apprentice- OPERATING ENGINEERS"						
SPECIALIZED EARTH MOVING EQUIP < 35 TONS <i>TEAMSTERS JOINT COUNCIL NO. 10 ZONE A</i>	12/01/2020	\$36.54	\$12.91	\$0.00	\$0.00	\$49.45
	06/01/2021	\$37.34	\$12.91	\$0.00	\$0.00	\$50.25
	08/01/2021	\$37.34	\$13.41	\$0.00	\$0.00	\$50.75
	12/01/2021	\$37.34	\$13.41	\$0.00	\$0.00	\$50.75
SPECIALIZED EARTH MOVING EQUIP > 35 TONS <i>TEAMSTERS JOINT COUNCIL NO. 10 ZONE A</i>	12/01/2020	\$36.83	\$12.91	\$0.00	\$0.00	\$49.74
	06/01/2021	\$37.63	\$12.91	\$0.00	\$0.00	\$50.54
	08/01/2021	\$37.63	\$13.41	\$0.00	\$0.00	\$51.04
	12/01/2021	\$37.63	\$13.41	\$0.00	\$0.00	\$51.04
TRACTORS/PORTABLE STEAM GENERATORS <i>OPERATING ENGINEERS LOCAL 4</i>	12/01/2020	\$49.45	\$13.50	\$0.00	\$0.00	\$62.95
	06/01/2021	\$50.54	\$13.50	\$0.00	\$0.00	\$64.04
	12/01/2021	\$51.68	\$13.50	\$0.00	\$0.00	\$65.18
For apprentice rates see "Apprentice- OPERATING ENGINEERS"						
TRAILERS FOR EARTH MOVING EQUIPMENT <i>TEAMSTERS JOINT COUNCIL NO. 10 ZONE A</i>	12/01/2020	\$37.12	\$12.91	\$0.00	\$0.00	\$50.03
	06/01/2021	\$37.92	\$12.91	\$0.00	\$0.00	\$50.83
	08/01/2021	\$37.92	\$13.41	\$0.00	\$0.00	\$51.33
	12/01/2021	\$37.92	\$13.41	\$0.00	\$0.00	\$51.33
VAC-HAUL/CATCH BASIN CLEANING <i>TEAMSTERS JOINT COUNCIL NO. 10 ZONE A</i>	12/01/2020	\$36.54	\$12.91	\$0.00	\$0.00	\$49.45
	06/01/2021	\$37.34	\$12.91	\$0.00	\$0.00	\$50.25
	08/01/2021	\$37.34	\$13.41	\$0.00	\$0.00	\$50.75
	12/01/2021	\$37.34	\$13.41	\$0.00	\$0.00	\$50.75

Additional Apprentice Information:

Minimum wage rates for apprentices employed on public works projects are listed above as a percentage of the pre-determined hourly wage rate established by the Commissioner under the provisions of the M.G.L. c. 149, ss. 26-27D. Apprentice ratios are established by the Division of Apprenticeship Training pursuant to M.G.L. c. 23, ss. 11E-11L.

All apprentices must be registered with the Division of Apprenticeship Training in accordance with M.G.L. c. 23, ss. 11E-11L.

All steps are six months (1000 hours.)

Ratios are expressed in allowable number of apprentices to journeymen or fraction thereof, unless otherwise specified.

** Multiple ratios are listed in the comment field.

*** APP to JM; 1:1, 2:2, 2:3, 3:4, 4:4, 4:5, 4:6, 5:7, 6:7, 6:8, 6:9, 7:10, 8:10, 8:11, 8:12, 9:13, 10:13, 10:14, etc.

**** APP to JM; 1:1, 1:2, 2:3, 2:4, 3:5, 4:6, 4:7, 5:8, 6:9, 6:10, 7:11, 8:12, 8:13, 9:14, 10:15, 10:16, etc.

ATTACHMENT B - (MBE/EEO/AA) POLICIES

THE COMMONWEALTH OF MASSACHUSETTS

**SUPPLEMENTAL EQUAL EMPLOYMENT OPPORTUNITY,
ANTI-DISCRIMINATION AND AFFIRMATIVE ACTION PROGRAM**

I. Definitions

For purposes of this contract, “minority” refers to Asian-Americans, Blacks, Spanish Surname Americans, North American Indians, and Cape Verdeans. “Commission” refers to the Massachusetts Commission Against Discrimination.

II. Contractor’s Agreement

During the performance of this Contract the Contractor and all of the Subcontractors, hereinafter collectively referred to as the Contractor, for himself, the assignees and successors in interest, agree as follows:

In connection with the performance of work under this contract, the Contractor, for himself, the assignees and successors in interest, agree as follows:

In connection with the performance of work under this contract, the contractor shall not discriminate against any employee or applicant for employment because of race, color, religious creed, national origin, age or sex. The aforesaid provision shall include but not be limited to the following: employment upgrading, demotion or transfer; recruitment advertising; recruitment layoff; termination; rates of pay or other forms of compensation; conditions or privileges of employment; and selection for apprenticeship.

The Contractor shall post hereafter in conspicuous places, available for employees and applicants for employment, notices to be provided by the Commission setting forth the provisions of the Fair Employment Practices Law of the Commonwealth (M.G.L. Chapter 151B).

In connection with the performance of work under this contract, the Contractor, shall undertake in good faith affirmative action measures designed to eliminate any discriminatory barriers in the terms and conditions of employment on the grounds of race, color, religious creed, national origin, age or sex, and to eliminate and remedy any effects of such discrimination in the past. Such affirmative action shall entail positive and aggressive measure to ensure equal opportunity in the areas of hiring, upgrading, demotion or transfer, recruitment, layoff or termination, rate of compensation, and in-service or apprenticeship training programs. This affirmative action shall include all action required to guarantee equal employment opportunity for all persons, regardless of race, color, religious creed, national origin, age or sex. A purpose of this provision is to ensure to the fullest extent possible an adequate supply of skilled tradesmen for this and future Commonwealth public construction projects.

III. Remedial Action

As part of this obligation of remedial action under the foregoing section, the Contractor shall maintain on this project not less than the percent ratio of minority employee man hours to total man hours in each job category including but not limited bricklayers, carpenters, cement mason electricians, ironworkers, operating engineers, and those classes of work enumerated in Section 44C of Chapter 149 of the Massachusetts General Laws. The percentage ratio for this project is 5 percent.

In the hiring of minority journeymen, apprentices, trainees and advanced trainees, the Contractor shall rely on referrals from a multi-employer affirmative action program approved by the Commission's traditional referral methods utilized by the construction industry, and referrals from agencies, not more than three in number at any one time, designated by the Liaison Committee of the Commission.

IV. Records

At the discretion of the Commission there may be established for the life of the contract a body to be known as the Liaison Committee. The Liaison Committee shall be composed of one representative each from the agency or agencies administering this project, hereinafter called the administering agency, the Commission and such other representative as may be designated by the Commission in conjunction with the administering agency.

The Contractor or an agent designated by the Contractor as the on-site equal employment opportunity officer shall recognize the Liaison Committee as an affirmative action body, and shall establish a continuing working relationship with the Liaison Committee, consulting with the Liaison Committee on all matters related to minority recruitment, referral, employment and training.

The Contractor shall prepare projected manning tables on a quarterly basis. These shall be broken down into weekly projections of workers required in each trade. Copies shall be furnished one week in advance of the commencement of the period covered, and also when updated, to the Commission and Liaison Committee.

Records of employment referral orders, prepared by the Contractor, shall be made available to the Commission and Liaison Committee.

The Contractor shall prepare weekly reports in a form approved by the Commission of hours worked in each trade by each employee, identified as minority or non-minority. Copies of these shall be provided at the end of each such week to the Commission and to the Liaison Committee.

V. Affirmative Action in Negotiating with Minority Subcontractors

If the Contractor uses any subcontractor for any work performed under this contract, the Contractor shall take affirmative action to negotiate with qualified minority subcontractors. This affirmative action shall cover both pre-bid and post bid periods. It shall include notification to the Office of Minority Business Assistance (within the Executive Office of Communities and

Development) or its designee, while bids are in preparation, of all products, work or services for which the Contractor intends to negotiate bids.

VI Preference in Hiring

In the employment of journeymen, apprentices, trainees and advanced trainees, the Contractor shall give preference, first, to citizens of the Commonwealth who have served in the armed forces of the United States in time of war and have been honorably discharged there from or released for active duty therein, and who are qualified to perform the work to which the employment relates, and secondly, to citizens of the Commonwealth generally, and if such cannot be obtained in sufficient numbers, then to citizens of the United States.

The requirements of the above paragraph do not apply to any project, financed in whole or in part with Federal Funds.

VII. Access During Construction

A designee of the Commission and a designee of the Liaison Committee shall each have right of access to the construction site.

VIII. Compliance with Requirements

The Contractor shall comply with the provisions of Executive Order NO. 74, as amended by Executive Order No. 116 dated May 1, 1975, and of Chapter 151B as amended, of the Massachusetts General Laws, both of which are herein incorporated and made a part of this contract.

IX Non-Discrimination

The Contractor, in the performance of all work after award, and prior to completion of the contract work, will not discriminate on grounds of race, color, religious creed, national origin, age or sex in employment practices, in the selection or retention of subcontractors, or in the procurement of materials and rentals of equipment.

X. Solicitations for Sub-Contracts, and for the Procurement of Materials and Equipment

In all solicitations either by competitive bidding or negotiation made by the Contractor either for work to be performed under a subcontract or for the procurement of materials or equipment, each potential subcontractor or supplier shall be notified in writing by the Contractor of the Contractor's obligations under this contract relative to non-discrimination and affirmative action.

XI. Compliance - Information, Reports and Sanctions

1. The Contractor will provide all information and reports required by the administering agency or the Commission on instruction issued by either of them and will permit access

to its facilities an any books, records, accounts and other sources of information which may be determined by the Commission to affect the employment of personnel. This provision shall apply only to information pertinent to the Commonwealth's supplementary affirmative action contract requirements. Where information required is in the exclusive possession of another who fails or refuses this information, the Contractor shall so certify to the administering agency or the Commission as appropriate and shall set forth what efforts have been made to obtain the information.

2. Whenever the administering agency, the Commission, or the Liaison Committee believes the General Contractor or any Subcontractor may not be operating in compliance with the terms of this Section, the Commission directly or through its designated agent shall conduct an appropriate investigation, and may confer with the parties, to determine if such Contractor is operating in compliance with the terms of this Section. If the Commissioner or its agent finds the General Contractor or any subcontractor not in compliance, it shall make a preliminary report of noncompliance, and notify such Contractor in writing of such steps, as will in the judgment of the Commission or its agent bring such Contractor into compliance. In the event that such Contractor fails or refuses to fully perform such steps, the Commission shall make a final report of non-compliance, and recommend to the administering agency the imposition of one or more of the sanctions listed below. If, however, the Commission believes the General contractor or any Subcontractor has taken or is taking every possible measure to achieve compliance, it shall not make a final report of non-compliance. Within fourteen days of receipt of the recommendations of the Commission, the administering agency shall move to impose one or more of the following sanctions, as it may deem appropriate to attain full and effective enforcement.
 - a. The recovery by the administering agency from the General Contractor of 1/100 of 1% of the contract award price or \$1000 whichever sum is greater in the nature of liquidated damages or, if a Subcontractor is in non-compliance, the recovery by the administering agency from the General Contractor, to be assessed by the General Contractor as back charge against the Subcontractor, of 1/10 of 1% of the subcontractor price, or \$400 whichever sum is greater, in the nature of liquidated damages, for each week that such party fails or refuses to comply.
 - b. The suspension of any payment or part thereof due under the contract until such time as the General Contractor or any Subcontractor is able to demonstrate within a specified time his compliance with the terms of the contract.
 - c. The termination, or cancellation, of the contract, in whole or in part, unless the general Contractor or any Subcontractor is able to demonstrate within a specified time his compliance with the terms of the contract.
 - d. The denial of the General Contractor or any Subcontractor of the right to participate in any future contracts awarded by the administering agency for a period of up to three years.
3. If any time after the imposition of one or more of the above sanctions a Contractor is able

to demonstrate compliance with this Section, a request may be made to the administering agency, in consultation with the Commission, to suspend the sanctions conditionally pending a final determination by the Commission as to whether the Contractor is in compliance. Upon final determination of the Commission, the administering agency, based on the recommendation of the Commission, shall either lift the sanction or reimpose them.

4. Sanctions enumerated under Sections XI-2 shall not be imposed by the administering agency except after an adjudicatory proceeding, as that term is used in M.G.L. Chapter 30A, has been conducted. No investigation by the Commission or its agent shall be initiated without prior notice to the Contractor.

XII. Severability

The provisions of this section are severable, and if any of these provisions shall be held unconstitutional by any court of competent jurisdiction, the decision of such court shall not effect or impair any of the remaining provisions.

XIII. Bidder's Requirements

The bidder will comply with the minority manpower ratio and specific affirmative action steps contained herein. The bidder shall obtain from each of its subcontractors and submit to the contracting or administering agency prior to the award of any subcontract under this contract the subcontractor certification required by these bid conditions.

XIV. Subcontractors' Certification

Prior to the award for any subcontract under this Notice to Contractors, regardless of tier, the prospective subcontractor must execute and submit to the Prime Contractor the following certification, which will be deemed a part of the resulting subcontract:

SUBCONTRACTORS' CERTIFICATION

_____ certifies that:
(Subcontractor)

1. It tends to use the following listed construction trades in the work under the subcontract:

_____ ; and

2. Will comply with the Minority manpower ratio and specific affirmative action steps contained herein.

(Signature of authorized representative of Subcontractor)

In order to ensure that the said subcontractors' certification becomes a part of all subcontracts under the prime contract, no subcontract shall be executed until an authorized representative of the Town has determined, in writing, that the said certification has been incorporated in such subcontract, regardless of tier. Any subcontract executed without such written approval shall be void.

XV. Materiality

The Requirements made of the bidder pursuant to these bid conditions are material, will govern the bidders performance on the project and will be made part of the bid.

MINIMUM MINORITY PERCENTAGES TO BE APPLIED TO STATE AND STATE ASSISTED CONTRACTS WITHIN THE COMMONWEALTH OF MASSACHUSETTS

The following percentages shall apply:

AREA

NOT LESS THAN

Boston:

- Impact Area [Jamaica Plain (part), Mattapan, South Cove, Chinatown, Bay Village, Roxbury, Dorchester, and South End].	30%
- Other parts of Boston	10%
Cambridge	12%
New Bedford	18%
Springfield	10%
All other cities and towns	5%

END OF ATTACHMENT

SECTION 01014

SCOPE AND SEQUENCE OF WORK

1. General
2. Scope of Work
3. Description of Work
4. Sequence of Work

1. General

- A. This Section of the specifications covers the scope and sequence of work for the “2021 Sewer On-Call Services” in Dedham, Massachusetts.
- B. The Contractor shall furnish all labor, materials, equipment, and incidentals required to complete the work as shown on the drawings and as specified herein.
- C. Sewer system rehabilitations include:
 1. Chemical root treatment (Refer to Section 02437, SEWER LINE AND MANHOLE CHEMICAL ROOT TREATMENT);
 2. Light/Heavy Cleaning and inspection of sewer mains (refer to Section 02440, SEWER CLEANING AND TELEVISION INSPECTION);
 3. Lining of sewer mains (manhole to manhole) to repair and seal multiple cracks and holes which are leaking or have the potential to leak (refer to Section 02428 CURED-IN-PLACE PIPE);
 4. Installing short liners in sewer mains to repair and seal cracks and holes which are leaking or have the potential to leak (refer to Section 02429, CURED-IN-PLACE SHORT LINER);
 5. Rehabilitating manholes including invert sealing, exterior sealing and interior coating (refer to Section 02435, SEWER MANHOLE REHABILITATION).
 6. Rehabilitation service connections including cutting protruding services; television inspecting, pressure testing and grouting to repair and seal cracks and holes which are leaking or have the potential to leak or to seal a reinstated service connection at a liner (refer to Section 02453 SERVICE CONNECTION REHABILITATION).

2. Scope of Work

- A. The scope of work under this contract includes the emergency cleaning of sewers (24-hours a day) based on an hourly rate, the cleaning and inspection of sewers based on an hourly rate, the wet weather cleaning and television inspection of sewers ranging in pipe diameter from 4-inch to 36-inch, structural short liners, structural line pipe (cured-in-place), and rehabilitation (external chemical grouting and internal cementitious lining) of sewer manholes. The contract is in the Town of Dedham, Massachusetts.
- B. The location, general characteristics, and principal details of the work will be provided as a “work order” from the Owner. The “work order” will detail the work requested and may include drawings, maps, and sketches to describe the location of work.
- C. The Contractor must have the capability to respond to a request to perform work within 2-hours’ notice (24-hours per day) for emergency cleaning, and the capability to respond to a request to perform work within 10 consecutive calendar days outside of emergency cleaning. Wet weather cleaning and television inspection work shall be performed between March 1st – May 31st and the contractor must have the ability to perform the quantity of work included in the contract during that time period. The Contractor is cautioned that under this contract there is no guarantee of consistent workload volume throughout the length of the Contract.

3. Sequence of Work

- A. Light cleaning shall be conducted before television inspection of sewer mains.
- B. Cutting of protruding service connections required in a segment of sewer (manhole to manhole) shall be performed prior to the installation of short liners required in that segment.
- C. Lining (manhole to manhole) and short liners required in a segment of sewer (manhole to manhole) shall be completed prior to any pressure testing (except for pre-television inspection prior to lining), grouting of service connections or installation of lateral liners required in that segment.
- D. Lining (manhole to manhole) required in a segment of sewer (manhole to manhole) shall be completed prior to any sewer manhole rehabilitation in that segment.
- E. All work may be scheduled at the Contractor’s discretion within the time of contract so long as it adheres to this scope and sequence of work and all plans and specifications. The schedule is also subject to approval by the Owner.

END OF SECTION

SECTION 01110

CONTROL OF WORK AND MATERIALS

1. Hauling, Handling and Storage of Materials
2. Easement
3. Maintenance of Traffic
4. Care and Protection of Property
5. Protection and Relocation of Existing Structures and Utilities
6. Maintenance of Flow
7. Rejected Materials and Defective Work
8. Sanitary Regulations
9. Safety and Health Regulations
10. Site Investigation
11. Hazardous Waste

1. Hauling, Handling and Storage of Materials

- A. The Contractor shall, at his own expense, handle and haul all materials furnished by him and shall remove any of his surplus materials at the completion of the work.
- B. The Contractor shall provide suitable and adequate storage for equipment and materials furnished by him that are liable to injury and shall be responsible for any loss of or damage to any equipment or materials by theft, breakage, or otherwise.
- C. The Contractor shall be responsible for all damages to the work under construction during its progress and until final completion and acceptance even though partial payments have been made under the Contract.

2. Easements

- A. As indicated on the drawings, the work may be located in easements obtained by the Owner. The Contractor has no rights outside of the easements unless they are obtained from the property owner
- B. Contractor shall schedule work so that it will cause minimum inconvenience and nuisance to abutting property owners, over the shortest possible time.
- C. Easements shall be kept clean; no rubbish or discarded construction materials shall be allowed to accumulate. Storage of excess construction materials, including soil, ledge, equipment, or machinery on easements will not be allowed.
- D. Restoration of fences, shrubs, trees and grass shall be completed promptly following completion of the work in an easement, to minimize disruption and inconvenience to property owners.

E. Unless approved by the Engineer, the use of easements for ease of access to and egress from other areas of the project will not be permitted.

3. Maintenance of Traffic

A. Should the Chief of Police deem it necessary, uniformed officers will be assigned to direct traffic. The Contractor shall make all arrangements in obtaining the uniformed officers required.

B. The Contractor shall at his own expense, as directed by the Police Traffic Control/Safety Officer, provide and erect acceptable barricades, barrier fences, traffic signs, and all other traffic devices not specifically covered in a bid item, to protect the work from traffic, pedestrians, and animals. He shall provide sufficient temporary lighting such as lanterns/flashers (electric battery operated) or other approved illuminated traffic signs and devices to afford adequate protection to the traveling public, at no additional cost to the Owner. See Section 01552 CONSTRUCTION ZONE SAFETY PLAN.

C. The Contractor shall furnish all construction signs that are deemed necessary by and in accordance with Part VI of the Manual on Uniform Traffic Control Devices as published by the U.S. Department of Transportation. In addition, the Contractor may be required to furnish up to 128 square feet of additional special construction warning signs. Size and exact wording of signs shall be determined by the Engineer during construction.

D. The intent of policing is to ensure public safety by direction of traffic. Police officers are not to serve as watchmen to protect the Contractor's equipment and materials.

E. Nothing contained herein shall be construed as relieving the Contractor of any of his responsibilities for protection of persons and property under the terms of the Contract.

4. Care and Protection of Property

The Contractor shall be responsible for the preservation of all public and private property, and shall use every precaution necessary to prevent damage thereto. If any direct or indirect damage is done to public or private property by or on account of any act, omission, neglect, or misconduct in the execution of the work on the part of the Contractor, such property shall be promptly restored by the Contractor, at his expense, to a condition similar or equal to that existing before the damage was done, to the satisfaction of the Engineer.

5. Protection and Relocation of Existing Structures and Utilities

A. All existing buildings, utilities, pipes, poles, wires fences, curbing, property line markers and other structures which the Engineer decides must be preserved in place

without being temporarily or permanently relocated, shall be carefully supported and protected from damage by the contractor. Should such property be damaged, it shall be restored by the Contractor, at no additional cost to the Owner.

- B. The Contractor shall determine the location of all underground structures and utilities (including existing water services, drain lines, electrical lines, and sewers). Services to buildings shall be maintained, and all costs or charges resulting from damage thereto shall be paid by Contractor.
- C. When fences interfere with the Contractor's operations, he shall remove and (unless otherwise specified) promptly restore them.
- D. Protection or temporary removal and replacement of existing utilities and structures as described in this Section shall be a part of the work under the Contract and all costs in connection therewith shall be included in the Total Price Bid in the BID FORM.
- E. On paved surfaces the Contractor shall not use or operate tractors, bulldozers, or other power-operated equipment with treads or wheels which are shaped so as to cut or otherwise damage such surfaces.
- F. All property damaged by the Contractor's operations shall be restored to a condition at least equal to that in which it was found immediately before work was begun. Suitable materials and methods shall be used for such restoration.
- G. Restoration of existing property and structures shall be carried out as promptly as practicable and shall not be left until the end of the construction period.

6. Maintenance of Flow

- A. The Contractor shall at his own cost, provide for the flow of sewers and drains interrupted during the progress of the work, and shall immediately cart away and dispose of all offensive matter. The entire procedure of maintaining existing flow shall be fully discussed with the Engineer well in advance of the interruption of any flow.
- B. All existing drainage facilities including, but not limited to; brooks, streams, canals, channels, ditches, culverts, catch basins and drainage piping shall be adequately safeguarded so as not to impede drainage or to cause siltation of downstream areas in any manner whatsoever. If the Contractor damages or impairs any of the aforesaid drainage facilities, he shall repair the same within the same day.
- C. At the conclusion of the work, the Contractor shall remove all silt in drainage structures caused by his operations as described in Section 01740, CLEANING UP.

7. Rejected Materials and Defective Work

- A. Materials furnished by the Contractor and condemned by the Owner as unsuitable or not in conformity with the specifications shall forthwith be removed from the work by the Contractor, and shall not be made use of elsewhere in the work.
- B. Any errors, defects or omissions in the execution of the work or in the materials furnished by the Contractor, even though they may have been passed or overlooked or have appeared after the completion of the work, discovered at any time before the final payment is made hereunder, shall be forthwith rectified and made good by and at the expense of the Contractor and in a manner satisfactory to the Engineer.
- C. The Contractor shall reimburse the Owner for any expense, losses or damages incurred in consequence of any defect, error, omission or act of the Contractor or his employees, as determined by the Engineer, occurring previous to the final payment.

8. Sanitary Regulations

Sanitary conveniences for the use of all persons employed on the work, properly screened from public observation, shall be provided in sufficient numbers in such manner and at such locations as may be approved. The contents shall be removed and disposed of in a satisfactory manner as the occasion requires. The Contractor shall rigorously prohibit the committing of nuisances within, on or about the work. Any employees found violating these provisions shall be discharged and not again employed on the work without the written consent of the Owner. The sanitary conveniences specified above shall be the obligation and responsibility of the Contractor.

9. Safety and Health Regulations

This project is subject to the Safety and Health regulations of the U.S. Department of Labor set forth in 29 CFR, Part 1926, and to the Massachusetts Department of Labor and Industries, Division of Industrial Safety "Rules and Regulations for the Prevention of Accidents in Construction Operations (454 CMR 10.0 et. seq.)." Contractors shall be familiar with the requirements of these regulations.

10. Site Investigation

The Contractor acknowledges that he has satisfied himself as to the conditions existing at the site of the work, the type of equipment required to perform this work, the quality and quantity of the materials furnished insofar as this information is reasonably ascertainable from an inspection of the site, as well as from information presented by the drawings and specifications made a part of this contract. Any failure of the Contractor to acquaint himself with available information will not relieve him from the responsibility for estimating properly the difficulty or cost of successfully performing the work. The Owner assumes no responsibility for any conclusion or interpretation made by the Contractor on the basis of the information made available by the Owner.

11. Hazardous Waste

Should the Contractor, while performing work under this contract, uncover hazardous materials, as defined in Massachusetts Hazardous Waste Regulations 310 CMR 30.00, he shall immediately notify the Owner. The Contractor is not, and has no authority to act as, a handler, generator, operator or disposer of hazardous or toxic substances found or identified at the site, and the Owner shall undertake all such functions.

END OF SECTION

SECTION 01140

SPECIAL PROVISIONS

1. Water for Construction Purposes
2. Dimensions of Existing Structures
3. Occupying Private Property
4. Coordination of Work
5. Time for Completion of Contract
6. Compliance with Permits
7. Contractor's Representative
8. Hours of Construction Activity
9. Construction Crews
10. Other Contracts
11. Massachusetts Data Security Regulations

1. Water for Construction Purposes

The Contractor is required to secure a permit and hydrant meter from the Dedham-Westwood Water District (50 Elm Street, Dedham, Massachusetts, 02027) for the use of water. The Contractor will be responsible for all costs associated with water including, but not limited to permits, deposits and water used.

If no water is available, the Contractor shall supply water at no additional cost to the Owner.

2. Dimensions of Existing Structures

Where the dimensions and locations of existing structures are of critical importance in the installation or connections of new work, the Contractor shall verify such dimensions and locations in the field before the fabrication of any material or equipment which is dependent on the correctness of such information.

3. Occupying Private Property

The Contractor shall not enter upon nor occupy with men, equipment or materials any property outside of the public highways or Owner's easements, except with the written consent of the property owner or property owner's agent.

4. Coordination of Work

The General Contractor shall be responsible for coordinating his own work as well as that of any subcontractors. He shall be responsible for notification of the Owner when each phase of work is expected to begin and the approximate completion date.

5. Time for Completion of Contract

The time for completion of this contract is stipulated in the Form of General Bid. The Bidder shall base his bid on completing the proposed work by the completion date stipulated in Section 00300, BID FORM.

6. Compliance with Permits

The Contractor shall perform all work in conformance with requirements of the Permits, which appear in Section 00890 - PERMITS.

7. Contractor's Representative

The Contractor shall designate a representative who will be available to respond to emergency calls by the Owner at any time day and night and on weekends and holidays should such a situation arise.

8. Hours of Construction Activity

A. The Contractor shall conduct all construction activity between 7:00 a.m. and 5:00 p.m., Monday through Friday. However, when utilizing police details, the Contractor shall limit the hours of operations which utilize those details to no more than 8-hours. No construction work shall be allowed on Saturdays, Sundays or Holidays without written authorization from the Owner.

B. The Contractor shall limit construction activity to between 9:00 a.m. and 3:00 p.m. on major commuter routes as specified by the Dedham Police Department. The Contractor is not eligible for any claim for delays or damages resulting from limited hours of construction activity.

9. Construction Crews

The Contractor shall not increase the number of construction crews assigned to the work without providing one-week advance notice to the Owner.

10. Other Contracts

A. The Contractor should be aware that work under this contract is part of a larger construction program. Other contracts in progress and proposed under this program are dependent upon completion of work under this contract.

- B. Successful completion of the entire construction program is dependent upon the cooperation of all parties involved. Interference and delay resulting from a lack of cooperation by all parties shall not be a basis for claims against the Owner.

11. Massachusetts Data Security Regulations

- A. The Contractor is required to comply with data security regulations contained in 201 CMR 17.00 that have been established to safeguard personal information of Massachusetts residents contained in paper or electronic records. The Contractor shall not submit to the Engineer or Owner documents in paper or electronic form that contain personal information (person's name combined with one or more of the following – Social Security Number, driver's license number or state-issued identification card number, financial institution account number, or credit or debit card number). Any document submitted to the Engineer that violates this provision shall be returned to the Contractor and the Contractor shall remove personal information from the document prior to resubmitting it to the Engineer. The Contractor shall require each Subcontractor to also comply with the MA data security regulations insofar as they involve submittal of personal information to the Engineer and Owner.

END OF SECTION

SECTION 01270

MEASUREMENT AND PAYMENT

PART 1 - DESCRIPTION

1.01 GENERAL:

- A. The following subsections describe the measurement of and payment for the work to be done under the items listed in Section 00300 BID FORM.
- B. All work performed as described in these contract documents will be paid for under one or more of the items listed in the BID FORM. All other activities required in connection with performance of the work, including all work required under Division 1, GENERAL REQUIREMENTS, whether described in the contract documents or mandated by applicable codes, permits and laws, will not be separately paid for unless specifically provided for in the form of general bid, but will be considered incidental to performance of the overall project.
- C. Each unit or lump-sum price stated in the BID FORM shall constitute full compensation as herein specified for each item of work completed in accordance with the drawings and specifications.
- D. The payment items listed herein and in the BID FORM are intended to provide full payment for the work shown on the drawings and specified herein. Any work called for or implied in the documents but not listed as a payment item shall be considered incidental to the overall project.
- E. Unless otherwise noted, each item shall be furnished and installed in accordance with the technical section whether a specific applicable payment item exists or not.

1.02 CLEANING & INSPECTION OF SEWERS

A. Cleaning and Inspection of Sewers:

- 1. The work under this item shall be measured at the unit price bid per linear foot of sewer cleaned and inspected.
- 2. Cleaning shall consist of a minimum of two (2) full passes of a hydraulic flusher. No settled debris shall be allowed to remain in the sewer, including: debris built up in drop connections, washed into service connections, or deposited on manhole benches and inverts. No debris shall be allowed to flow downstream of the cleaning manhole.

3. Measurement shall be based on the actual length of sewer inspected from center line of manhole to center line of manhole. Sewers shall be inspected as specified in Section 02440, SEWER CLEANING AND TELEVISION INSPECTION.
4. The television inspection work, video formats, by-pass pumping, light cleaning of sewers, plugging or blocking of sewer flow, and the storage, testing and disposal of any material retrieved from sewer cleaning shall be considered incidental to the work and shall not be considered for payment.
5. The work under this section shall be paid at the contract unit price under the appropriate subdivision of Item under Item 4.
6. Cleaning and television inspection of the laterals shall be paid for under the appropriate subdivision of Item 4.

B. Heavy Cleaning of Sewers:

1. The work under this item shall be measured at the unit price bid per linear foot of sewer heavy cleaned.
2. Measurement shall be based on the actual length of sewer heavy cleaned from center line of manhole to center line of manhole. Sewers shall be heavy cleaned as specified in Section 02440, SEWER CLEANING AND TELEVISION INSPECTION. Verification of adequate cleaning shall be made by television inspection.
3. The sewer heavy cleaning work, by-pass pumping, plugging or blocking of sewer flow, and the storage, testing and disposal of any material retrieved from sewer cleaning shall be considered incidental to the work and shall not be considered separately for payment.
4. The work under this section shall be paid at the contract unit price under the appropriate subdivision of Item under Item 3.

1.03 SHORT LINER:

A. General:

1. The work of this item shall be measured at the unit price bid per linear foot of short liner installed.
2. Measurement, including all material, labor, tools and equipment shall be based on the actual length of installed short liners in sewer lines as determined by the Owner. Short liners shall be installed as specified in Section 02429, CURED-IN-PLACE SHORT LINER.

3. Bypass pumping and plugging or blocking of sewer flow shall be considered incidental to the work and shall not be measured separately for payment.
 4. Reinstating, grouting and cutting protruding service connections shall be considered incidental to the work and shall not be measured separately for payment. This work shall be performed as specified in Section 02453, SERVICE CONNECTION REHABILITATION.
 5. Cleaning and television inspection of sewer lines with short liners shall be considered incidental to the work and shall not be measured separately for payment.
 6. Grouting of any infiltration sources required to install the liner shall be considered incidental to the work and shall not be measured separately for payment.
 7. The work shall be paid for at the contract unit price under the appropriate subdivision of Item 6.
- B. Ten percent of the payment for subdivisions of the item “On-Call Sewer Repair” shall be withheld until the pipeline rehabilitation’s have satisfactorily completed and passed field testing/inspection(s) as specified in Section 02429, CURED-IN-PLACE SHORT LINER.

1.04 CURED-IN-PLACE PIPE:

A. General:

1. The work of this item shall be measured at the unit price bid per linear foot structural line pipe measured from manhole centerline to manhole centerline.
2. Measurement, including all material, labor, tools and equipment shall be based on the actual length of pipes lined from centerline of manhole to centerline of manhole as determined by the Owner. Pipes shall be lined as specified in Section 02428, CURED-IN-PLACE PIPE.
3. Bypass pumping and plugging or blocking of sewer flow shall be considered incidental to the work and shall not be measured separately for payment.
4. Reinstating, grouting and cutting protruding service connections shall be considered incidental to the work and shall not be measured separately for payment. This work shall be performed as specified in Section 02453, SERVICE CONNECTION REHABILITATION.
5. Cleaning and television inspection of lined sewer pipes shall be considered incidental to the work and shall not be measured separately for payment.

6. Grouting of any infiltration sources required to install the liner shall be considered incidental to the work and shall not be measured separately for payment.
 7. The work shall be paid for at the contract unit price under the appropriate subdivision of Item 6.
- B. Ten percent of the payment for subdivisions of the item “On-Call Sewer Repair” shall be withheld until the pipeline rehabilitation’s have satisfactorily completed and passed field testing/inspection(s) as specified in Section 02428, CURED-IN-PLACE PIPE.

1.05 MANHOLE REHABILITATION:

A. Exterior Chemical Grouting and Interior Cementitious Lining:

1. The work of this item shall be measured per vertical foot from the invert to the rim of the sewer manhole rehabilitated through internal and external sealing.
 2. The contract unit price per vertical foot to be paid shall constitute full compensation for supplying all material, labor, tools, and equipment required to seal the interior and exterior of the manholes as specified in Section 02435, SEWER MANHOLE REHABILITATION. Manhole cementitious lining includes invert sealing, exterior chemical grouting, and interior lining.
 3. Cleaning the manhole and plugging or grouting of active leaks in the manhole structure prior to lining shall be considered incidental to the work and will not be measured separately for payment.
 4. Bypass pumping and plugging or blocking of sewer flow shall be considered incidental to the work and shall not be measured separately for payment.
 5. Sealing of manhole inverts shall be considered incidental to the exterior chemical grouting work and shall not be measured separately for payment.
 6. The work shall be paid for at the contract unit price under the appropriate subdivision of Item 7.
- B. Ten percent of the payment for subdivisions of the item “Manhole Rehabilitation” shall be withheld until the manhole rehabilitation’s have satisfactorily completed and passed field testing/inspection(s) as specified in Section 02435, SEWER MANHOLE REHABILITATION.

1.06 SERVICE CONNECTION REHABILITATION:

1. Cutting protruding service connections in accordance with the specifications shall be considered incidental to the work and shall not be measured separately for

payment.

2. Grouting service connections in accordance with the specifications shall be considered incidental to the work and shall not be measured separately for payment.

1.07 CHEMICAL ROOT TREATMENT:

A. Sewer Line Chemical Root Treatment:

1. Chemical root treatment shall be measured at the unit price bid per linear foot of sewer treated.
2. Measurement shall be based on the actual length of treated sewer from center line of manhole to center line of manhole. Sewers shall be chemically treated for root control as specified in Section 02437, SEWER LINE AND MANHOLE CHEMICAL ROOT TREATMENT.
3. Bypass pumping and plugging or blocking of sewer flow shall be considered incidental to the work and shall not be measured separately for payment.
4. The work under this section shall be paid at the contract unit price under Items 9.

B. Manhole Chemical Root Treatment:

1. Chemical root treatment shall be measured at the unit price bid per manhole treated.
2. The contract unit price per manhole to be paid shall constitute full compensation for supplying all material, labor, tools, and equipment required to chemically treat the manholes for root control as specified in Section 02435, SEWER MANHOLE SEALING and Section 02437, SEWER LINE CHEMICAL ROOT TREATMENT.
3. Bypass pumping and plugging or blocking of sewer flow shall be considered incidental to the work and shall not be measured separately for payment.
4. The work under this section shall be paid at the contract unit price under Item 9.

1.08 UNIFORMED OFFICERS FOR TRAFFIC CONTROL:

A. Services of uniformed officers for traffic control:

1. The services of uniformed officers properly arranged and utilized, as per Section 02451 UNIFORMED OFFICERS FOR TRAFFIC CONTROL, shall be paid directly by the Owner.

2. The Contractor shall forward copies of the police detail slips documenting the location, officer, and time worked to the Owner on a weekly basis. Actual payment to the traffic authority shall be made by the Owner.

The Contractor shall be responsible for payments for the services of uniformed officers required for repeat work due to work deemed unsatisfactory or performed due to the Contractor's negligence. The Contractor shall be solely responsible for all costs incurred due to unsatisfactory work or negligence.

1.09 MOBILIZATION:

The lump sum for this item shall constitute full compensation to the Contractor for the general mobilization necessary to make the contract operational, exclusive of the cost of materials. The total for Item No. 5 mobilization shall not exceed 5 percent of the total of bid Items 3 to 4. The total for Item No. 8 mobilization shall not exceed 5 percent of the total of bid Items 6 to 7. The total for Item No. 10 mobilization shall not exceed 5 percent of the total of bid Item 9.

1.10 HANDLING EXISTING FLOWS:

Handling existing sewage flows in accordance with the specifications, including providing, installing, and removing all required equipment, piping, and pumping as required shall not be measured separately for payment, but shall be considered incidental to the project.

1.11 SURFACE RESTORATION:

A. The work for surface restoration shall include loaming and seeding and all incidentals thereto for all disturbed areas. This work shall not be separately measured for payment, but shall be considered incidental to the project.

B. Any existing fences which are required to be removed and reset shall not be separately measured for payment, but shall be considered incidental to the project.

1.12 ENVIRONMENTAL PROTECTION:

The work of this section shall not be separately measured for payment, but shall be considered incidental to the project.

1.13 SIGNAGE:

The work of this section shall not be separately measured for payment, but shall be considered incidental to the project.

1.14 DOCUMENTATION:

Television inspection videos in MPEG and on DVD formats including the television inspection logs in PDF format, and manhole inspection logs including digital photos of each manhole inspection in PDF format to be provided to the Owner shall not be separately measured for payment but shall be considered incidental to the project.

1.15 WARRANTY INSPECTION:

All warranty inspections and related work shall not be separately measured for payment, but shall be considered incidental to the project.

1.16 TELEVISION INSPECTION VIDEOS AND LOGS:

Television inspection videos and logs provided to the Owner on an external hard drive shall not be separately measured for payment, but shall be considered incidental to the project.

END OF SECTION

SECTION 01330

SUBMITTALS

1. SHOP AND WORKING DRAWINGS

- A. As required by the General Conditions, Contractor shall submit a schedule of shop and working drawing submittals.
- B. In accordance with the accepted schedule, the Contractor shall submit promptly to the Owner. Copies of shop or working drawings required as noted in the specifications, of equipment, structural details and materials fabricated especially for this Contract shall be submitted to the Owner.
- C. Shop and working drawings shall show the principal dimensions, weight, structural and operating features, space required, clearances, type and/or brand of finish of shop coat, grease fittings, etc., depending on the subject of the drawings. When it is customary to do so, when the dimensions are of particular importance, or when so specified, the drawings shall be certified by the manufacturer or fabricator as correct for this Contract.
- D. All shop and working drawings shall be submitted to the Owner by and/or through the Contractor, who shall be responsible for obtaining shop and working drawings from his subcontractors and returning reviewed drawings to them. All shop and working drawings shall be prepared on standard size, 24-inch by 36-inch sheets, except those which are made by changing existing standard shop or working drawings. All drawings shall be clearly marked with the names of the Owner, Project, Contractor and building, equipment or structure to which the drawing applies, and shall be suitably numbered. Each shipment of drawings shall be accompanied by the Owner's (if applicable) standard shop drawing transmittal form on which is a list of the drawings, descriptions and numbers and the names mentioned above.
- E. Only drawings which have been prepared, checked and corrected by the fabricator should be submitted to the Contractor by his subcontractors and vendors. Prior to submitting drawings to the Owner, the Contractor shall check thoroughly all such drawings to satisfy himself that the subject matter thereof conforms to the Contract Documents in all respects. Shop drawings shall be reviewed and marked with the date, checker's name and indication of the Contractor's approval, and only then shall be submitted to the Owner. Shop drawings unsatisfactory to the Contractor shall be returned directly to their source for correction, without submittal to the Owner. Shop drawings submitted to the Owner without the Contractor's approval stamp and signature will be rejected. Any deviation from the Contract Documents indicated on the shop drawings must be identified on the drawings and in a separate submittal to the Owner, as required under subsection 6.17 Shop Drawings and Samples; D. Submittal Procedures, Paragraph 3 of the 1996 General Conditions.

- F. The Contractor shall be responsible for the prompt submittal and resubmittal, as necessary, of all shop and working drawings so that there will be no delay in the work due to the absence of such drawings.
- G. The Owner will review the shop and working drawings as to their general conformance with the design concept of the project and general compliance with the information given in the Contract Documents. Corrections of comments made on the drawings during the review do not relieve the Contractor from compliance with requirements of the Contract Documents. The Contractor is responsible for: confirming and correlating all quantities and dimensions; selecting fabrication processes and techniques of construction; coordinating his work with that of all other trades; and performing his work in a safe and satisfactory manner. The review of the shop drawings is general and shall not relieve the Contractor of the responsibility for details of design, dimensions, code compliance, etc., necessary for interfacing with other components, proper fitting and construction of the work required by the Contract and for achieving the specified performance.
- H. With few exceptions, shop drawings will be reviewed and returned to the Contractor within 30 days of submittal.
- I. No material or equipment shall be purchased or fabricated especially for this Contract nor shall the Contractor proceed with any portion of the work, the design and details of which are dependent upon the design and details of equipment or other features for which review is required, until the required shop and working drawings have been submitted and reviewed by the Owner as to their general conformance and compliance with the project and its Contract Documents. All materials and work involved in the construction shall then be as represented by said drawings.
- J. One copy of the shop and working drawings and/or catalog cuts will be returned to the Contractor. The Contractor shall furnish additional copies of such drawings or catalog cuts when he needs more than one copy or when so requested.

2. SAMPLES

- A. Samples specified in individual Sections include, but are not necessarily limited to, physical examples of the work such as sections of manufactured or fabricated work, small cuts or containers of materials, complete units of repetitively-used products, color/texture/pattern swatches and range sets, specimens for coordination of visual effect, graphic symbols, and units of work to be used by the Owner for independent inspection and testing, as applicable to the work.
- B. The number of samples submitted shall be as specified. Submittal and processing of samples shall follow the procedures outlined for shop and working drawings unless the specifications call for a field submittal or mock-up.
- C. Acceptance of samples will be acknowledged via a copy of the transmittal noting status. When samples are not acceptable, prompt resubmittal will be required.

END OF SECTION

SECTION 01331

DOCUMENTATION

PART 1 – GENERAL

1.01 WORK INCLUDED:

- A. This section covers the requirements for documentation to be furnished by the Contractor on this project.

1.02 RELATED WORK:

- A. Section 02428, CURED-IN-PLACE PIPE
- B. Section 02429, CURED-IN-PLACE SHORT LINER
- C. Section 02440, SEWER CLEANING AND INSPECTION

1.03 DOCUMENTATION:

- A. The Contractor shall maintain PDF format television inspection logs and recorded MPEG-4 (.mp4) format television inspection videos of sewer segments and laterals, for each sewer line segment or lateral undergoing cleaning and/or repair/rehabilitation under this contract. Log sheet format shall be approved by Owner prior to start of work.
- B. The log sheet(s) as a minimum shall clearly identify:
 - 1. Project Name
 - 2. Street Location, Name, Intersection, Station
 - 3. Date of inspection
 - 4. Total Length of Line Inspected
 - 5. Line Size(s)/Joint Spacing/Type
 - 6. Line and Manhole(s) Condition

7. Significant observations such as camera direction service connections, offset joints, drop joints, broken/cracked pipe, protruding services, roots, collapsed sections, infiltration, presence of scale and corrosion and other discernible features.
 8. Direction (Upstream or Downstream)
- C. All logs shall be provided to the Owner in PDF format (one PDF file including all Inspection logs for a particular project) within five (5) working days at the completion of the wet weather work and within ten (10) calendar days at the completion of the projects for sewer repairs.
 - D. All television inspections shall be recorded in accordance with the latest NASSCO PACP standards. The PACP defect-coding list shall be used to list and to document pipe conditions and identify all structural, operation and maintenance (O&M) defects, constructions and miscellaneous features. The inspection log will utilize a clock system for indication points of reference.
 - E. All television inspections shall be originally recorded as follows:
 - File Format: MPEG-4 (.mp4)
 - Codec: AVC (H.264)
 - Frame Size 16/9: 1280 x 720 or Frame Size 4/3: 960 x 720
 - Frame Rate: 60 fps
 - Pixel Aspect Ratio 1:1 (square pixels)
 - Video Standard: NTSC
 - Scan Type: Progressive

All television inspection shall include accompanying audio and shall be cross-referenced in a PACP Export provided by the Contractor. Inspections shall be recorded one at a time, with each segment recorded as a separate file on the external hard drive.

- F. The Contractor shall utilize CCTV inspection software that is NASSCO certified and capable of integrating seamlessly with other NASSCO certified data management software. The Contractor shall provide a PACP Export in MS Access from their CCTV software, which will contain the PACP code and rating for each defect and the PACP condition grading on PACP Version 6.0
- G. All PACP required header information must be fully and accurately entered on all CCTV reports. Asset ID information shall be obtained from the Engineer or the

Owner prior to inspection. Additional header information is required by the Owner including the following:

- Owner – Town of Dedham
 - Purpose of Survey – 2021 Sewer On-Call Services
 - Pipe Segment Reference shall contain upstream and downstream sub-area and manhole designations e.g. “AA100-AA90”
 - Total length and Length Surveyed
- H. Inspections shall be recorded one at a time, with each segment recorded as a separate file on the DVD or external hard drive. The Contractor shall provide two (2) original and labeled copies of each DVD for emergency and hourly rate work and external hard drives for wet weather and sewer repair work to the Owner, at no additional cost, as requested by the Owner during the Project. All DVDs and external hard drives shall have a typed label listing external hard drive number, date work was performed, Owner: Dedham, and Contractor name.
- J. The Contractor shall provide a report at the conclusion of these inspections. The report shall include all pertinent inspection data, including CCTV inspection. The report shall be submitted within thirty (30) days following the completion of work.
- K. The Contractor shall deliver to the Owner, at no additional cost an external hard drive each including the following information at the end of the project. The external hard drives shall be USB powered and capable of USB 3.0 connectivity and will become the property of the Owner upon delivery. The Contractor shall use file folders to organize individual types of data on the external hard drives. The Contractor shall include the following data on the external hard drives prior to delivery to the Owner.
- **Clean and Inspect (Pipes & Laterals)**
 - Television Inspection MPEG-4 Files
 - Filenames shall contain upstream and downstream sub-area and manhole designations e.g. “AA050-AA049”. For laterals, Station ID shall also be listed e.g. “AA050-AA049 Sta 0+10”
 - All television inspection logs as a single PDF file
 - **Cured-in-Place Short Liner (and Cured-in-Place Structural Short Liner)**
 - Post Television Inspection MPEG-4 Files
 - Filenames shall contain upstream and downstream sub-area and manhole designations e.g. “AA050-AA049”
 - All post television inspection logs as a single PDF file
 - **Cured-in-Place Pipe – Organized per Inversion**

- Pre-inversion Television Inspection MPEG-4 Files
 - Filenames shall contain upstream and downstream sub-area and manhole designations e.g. “AA050-AA049”
- All pre-inversion television inspection logs as a single PDF file
- Each service connection reinstatement sign-off sheet as a separate PDF file
- Post-inversion Television Inspection MPEG-4 Files
 - Filenames shall contain upstream and downstream sub-area and manhole designations e.g. “AA050-AA049”
- All post-inversion television inspection logs as a single PDF file
- Each material testing results report as a separate PDF file

END OF SECTION

SECTION 01380

HEALTH AND SAFETY PLAN

PART 1 - GENERAL

1.01 WORK INCLUDED:

A. Prior to the start of work on the site, Contractor shall prepare and submit a site-specific health and safety plan that includes consideration of all known and potential hazards at the site. Work may not proceed at the project site until the Contractor's health and safety plan has been received and reviewed by the Engineer.

1.02 REFERENCES:

A. OSHA 29 CFR 1910.120

PART 2 – PRODUCTS

2.01 HEALTH AND SAFETY PLAN:

- A. The health and safety plan shall include, but not necessarily be limited to the following:
1. Identification of Contractor's Site Safety Officer.
 2. Identification of Hazards and Risks Associated with Project.
 3. Contractor's Standard Operating Procedures, Including Personnel Training and Field Orientation.
 4. Respiratory Protection Training Requirements.
 5. Levels of Protection and Selection of Equipment Procedures.
 6. Type of Medical Surveillance Program.
 7. Personal Hygiene Requirements and Guidelines.
 8. Zone Delineation of the Project Site.
 9. Site Security and Entry Control Procedures.

10. Field Monitoring of Site Contaminants.
11. Contingency and Emergency Procedures.
12. Listing of Emergency Contacts.
13. COVID-19 compliance plan that is compliant with the most up to date state and federal regulations.

PART 3 - EXECUTION

3.01 PERSONAL PROTECTIVE EQUIPMENT:

- A. The personal protective equipment required to provide the appropriate level of dermal and respiratory protection shall be determined based on the results of continuous air monitoring performed by the Contractor and the standards set forth in the Contractor's health and safety plan. The Engineer may conduct duplicate air monitoring for quality control purposes. Modified Level D protection shall be the minimum requirement for all on-site personnel.

SECTION 01550

SIGNAGE (TRAFFIC CONTROL)

PART 1 - GENERAL

1.01 WORK INCLUDED:

This Section covers furnishing and installing traffic control signs and other devices.

1.02 SYSTEM DESCRIPTION:

The Contractor shall furnish and install all construction signs deemed necessary by and in accordance with the latest edition of Part VI of the Manual on Uniform Traffic Control Devices (MUTCD) as published by the U.S. Department of Transportation.

PART 2 - PRODUCTS

2.01 TRAFFIC WARNING AND REGULATING DEVICES:

Contractor shall provide warning signs, barricades and other devices in accordance with the specifications provided in the MUTCD. Size of signs, lettering, colors, method of support and other factors prescribed in the MUTCD shall be adhered to.

PART 3 - EXECUTION

3.01 INSTALLATION:

- A. Contractor shall erect barricades, barrier fences, traffic signs, and other traffic control devices as required by the MUTCD, or as directed by the Owner, to protect the work area from traffic, pedestrians, and animals.
- B. Contractor shall relocate barricades, signs and other devices as necessary as the work progresses.
- C. Unless extended protection is required for specific areas, when the work has been completed, all temporary warning and regulatory devices used by the Contractor shall be removed so that traffic can move unimpeded through the area.

END OF SECTION

SECTION 01552

CONSTRUCTION ZONE SAFETY PLAN

PART 1 - GENERAL

1.01 WORK INCLUDED:

- A. This Section covers the provisions for complying with Commonwealth of Massachusetts requirements for construction zone safety plans on public works projects.

1.02 DESCRIPTION:

- A. The Contractor shall implement traffic safety and control measures through the construction zone through road closures and detours and mitigate impacts on traffic outside of the construction zone in accordance with these contract documents.

1.03 RELATED WORK:

- A. SECTION 01110, CONTROL OF WORK AND MATERIALS
- B. SECTION 01550, SIGNAGE (TRAFFIC CONTROL)
- C. SECTION 02451, UNIFORMED OFFICERS FOR TEMPORARY TRAFFIC CONTROL

1.04 REFERENCES:

701 CMR 7.00 Use of Road Flaggers and Police Details on Public Works Projects

Massachusetts Department of Transportation Standard Specifications for Highways and Bridges – latest edition

PART 2 - PRODUCTS

- 2.01 Traffic control devices utilized by the Contractor shall meet the requirements of these contract documents and the latest Massachusetts Department of Transportation (MassDOT) Standard Specifications and Manual On Uniform Traffic Control Devices (MUTCD).

PART 3 - EXECUTION

3.01 OPERATION:

- A. Contractor shall be responsible for providing all temporary traffic control devices including barricades, barrier fences, signs, drums, cones, impact attenuators and other

traffic control devices in accordance with typical traffic management plans and details shown on the drawings or as required by the Engineer.

- B. The Contractor shall prepare temporary traffic management plans and details that deviates significantly from the typical plans shown on the drawings and submit to the Engineer for review and approval prior to start of the work.
- C. Contractor shall relocate barricades, signs and other devices as necessary as the work progresses as required by the Owner's Traffic Control Officer or the Engineer.
- D. Police details shall be utilized on this project as follows.
- E. If police details fail to show up for work at the construction zone at the usual time for start of work, or otherwise leave the jobsite before work is completed for the day, the provisions of the Alternative Plan will be followed by the Contractor.

3.02 ALTERNATIVE PLAN:

- A. In accordance with 701 CMR 7.06(6), whenever required police details do not arrive on time or fail to show up for work, the Alternative Plan will be implemented by the Contractor.
- B. The Alternative Plan for this project is as follows:
 - 1. Contact local police department and municipality to inform them the scheduled police detail has failed to show up at the project site.
 - 2. Redeploy crew to work in areas not requiring temporary traffic control (if available).

END OF SECTION

SECTION 01570
ENVIRONMENTAL PROTECTION

1. Description
2. Notification
3. Implementation
4. Area of Construction Activity
5. Protection of Water Resources
6. Protecting and Minimizing Exposed Areas
7. Location of Storage Areas
8. Protection of Landscape

1. Description

- A. The work covered by this section of the specifications consists of furnishing all labor, materials, tools and equipment and performing all work required for the prevention of environmental pollution during and as a result of construction operations under this contract.
- B. The requirements set forth in this section of the specifications apply to cross-country areas, river and stream crossings, and construction in and adjacent to wetlands, unless otherwise specifically stated.
- C. All work under this Contract shall be in accordance with the Conservation Commissions' Orders of Conditions as well as any conditional requirements applied.

2. Notification

The Owner will notify the Contractor in writing of any non-compliance with the foregoing provisions. The Contractor shall, after receipt of such notice, immediately take corrective action. Such notice, when delivered to the Contractor or his authorized representative at the site of the work, shall be deemed sufficient for the purpose. If the Contractor fails to act promptly, the Owner may order stoppage of all or part of the work until satisfactory corrective action has been taken. No claim for an extension of time or for excess costs or damage incurred by the Contractor as a result of time lost due to any stop work orders shall be made unless it was later determined that the Contractor was in compliance.

3. Implementation

- A. Prior to commencement of work, the Contractor shall meet with representatives of the Owner to develop mutual understandings relative to compliance of the environmental protection program.
- B. The Contractor shall submit for approval six sets of details and literature fully describing environmental protection methods to be employed in carrying out

construction activities within 100 feet of wetlands or across areas designated as wetlands.

4. Area of Construction Activity

Insofar as possible, the Contractor shall confine his construction activities to those areas defined by the plans and specifications. All land resources within the project boundaries and outside the limits of permanent work performed under this contract shall be preserved in their present condition or be restored to a condition after completion of construction at least equal to that which existed prior to work under this contract.

5. Protection of Water Resources

A. The Contractor shall not pollute streams, lakes or reservoirs with fuels, oils, bitumens, calcium chloride, acids or other harmful materials. It is the Contractor's responsibility to comply with all applicable Federal, State, County and Municipal laws regarding pollution of rivers and streams.

B. Special measures should be taken to insure against spillage of any pollutants into public waters.

6. Location of Storage Areas

A. The location of the Contractor's storage areas for equipment and/or materials shall be upon cleared portions of the job site or areas to be cleared as a part of this project, and shall require written approval of the Owner. Plans showing storage facilities for equipment and materials shall be submitted for approval of the Owner.

B. No excavated materials or materials used in backfill operations shall be deposited within a minimum distance of one hundred (100) feet of any watercourse or any drainage facility. Adequate measures for erosion and sediment control such as the placement of baled hay or straw around the downstream perimeter of stockpiles shall be employed to protect any downstream areas from siltation.

C. There shall be no storage of equipment or materials in areas designated as wetlands.

D. The Owner may designate a particular area or areas where the Contractor may store materials used in his operations.

E. Storage areas in cross-country locations shall be restored to pre-construction conditions with the planting of native species of trees and shrubs.

8. Protection of Landscape

A. The Contractor shall not deface, injure, or destroy trees or shrubs nor remove or cut them without written authority from the Owner. No ropes, cables, or guys shall be fastened to or attached to any existing nearby trees for anchorages unless specifically

- authorized by the Owner. Excavating machinery and cranes shall be of suitable type and be operated with care to prevent injury to trees which are not to be removed, particularly overhanging branches and limbs. The Contractor shall, in any event, be responsible for any damage resulting from such use.
- B. Branches, limbs, and roots shall not be cut except by permission of the Owner. All cutting shall be smoothly and neatly done without splitting or crushing. When there is unavoidable injury to branches, limbs and trunks of trees, the injured portions shall be neatly trimmed and covered with an application of grafting wax or tree healing paint as directed.
- C. Where, in the opinion of the Owner, trees may possibly be defaced, bruised, injured, or otherwise damaged by the Contractor's equipment or by his blasting or other operations, the Owner may direct the Contractor to adequately protect such trees by placing boards, planks, poles or fencing around them. Any trees or landscape feature scarred or damaged by the Contractor's equipment or operations shall be restored as nearly as possible to its original condition at the expense of the Contractor. The Owner will decide what method of restoration shall be used, and whether damaged trees shall be treated and healed or removed and disposed of under the provisions of Section 02230, CLEARING AND GRUBBING.
- D. Cultivated hedges, shrubs, and plants which could be injured by the Contractor's operations shall be protected by suitable means or shall be dug up, balled and temporarily replanted and maintained. After construction operations have been substantially completed, they shall be replanted in their original positions and cared for until growth is re-established. If cultivated hedges, shrubs, and plants are injured to such a degree as to affect their growth or diminish their beauty or usefulness, they shall be replaced by items of a kind and quality at least equal to that existing at the start of the work.

END OF SECTION

SECTION 01575

HANDLING EXISTING FLOWS

PART 1 - GENERAL

1.01 WORK INCLUDED:

This Section covers all materials, equipment, and labor required to handle existing sanitary and combined sewage flows and installation and maintenance of all temporary connections, plugs, and by-pass pumping. Upon completion of the work, all temporary plugs and connections shall be removed and flows returned to the existing system or flows transferred to the new pipes. Plug, fill, and abandon existing pipes and manholes as shown on the drawings or as specified herein.

1.02 RELATED WORK:

Section 01330 - SUBMITTALS

1.03 SUBMITTALS: IN ACCORDANCE WITH REQUIREMENTS OF GENERAL SPECIFICATIONS, SUBMIT THE FOLLOWING:

One (1) set of complete checked shop drawings, showing equipment, method of by-passing, and the method of transferring flows from the existing system to the new system.

PART 2 - PRODUCTS - NOT APPLICABLE

PART 3 - EXECUTION

3.01 MAINTAINING EXISTING FLOWS:

- A. The Contractor shall maintain all flows in the existing system until construction of the work is complete and ready for safe operation.
- B. The Contractor shall protect against surcharging of the existing system upstream of the work area by installing adequate temporary by-pass pumping to handle dry weather and wet weather flows. The bypass system shall have a sufficient capacity to handle full pipe capacity for the pipeline section to be bypassed times 1.25 and shall provide and maintain sufficient flow at all times to prevent any backwater flooding due to obstructions caused by the construction.
- C. The Contractor shall be restricted to within the Town's Public right-of-ways and easements for the purposes of by-pass pumping or any other method of handling

existing flows.

- D. The Contractor shall repair any damage that occurs to existing pipes and structures to the satisfaction of the Owner. Work performed under this section shall be considered incidental and shall not be measured separately for payment.
- E. The Contractor shall not allow sanitary flow to discharge to any salt or fresh water body by means of overflow, by-pass pumping, or any other method that may contaminate these water areas.

END OF SECTION

SECTION 01740

CLEANING UP

1. DESCRIPTION:

- A. The Contractor should be familiar with Section 00700 GENERAL CONDITIONS, Section 01110 CONTROL OF WORK AND MATERIALS, Section 01140 SPECIAL PROVISIONS, and Section 01570 ENVIRONMENTAL PROTECTION as they pertain to this section.
- B. The Contractor must employ at all times during the progress of his work adequate cleanup measures and safety precautions to prevent injuries to persons or damage to property. The Contractor shall immediately, upon direction by the Owner provide adequate material, equipment and labor to cleanup and make safe any and all areas deemed necessary by the Owner.

2. DAILY CLEANUP:

- A. The Contractor shall clean up, at least daily, all refuse, rubbish, scrap and surplus material, debris and unneeded construction equipment resulting from the construction operations and sweep the area. The site of the work and the adjacent areas affected thereby shall at all times present a neat, orderly and workmanlike appearance.
- B. Upon written notification by the Owner, the Contractor shall within 24 hours clean up those areas, which in the Owner's opinion are in violation of this section and the above referenced sections of the specifications.
- C. If in the opinion of the Owner, the referenced areas are not satisfactorily cleaned up, all other work on the project shall stop until the cleanup is satisfactory.

3. MATERIAL OR DEBRIS IN DRAINAGE FACILITIES:

Where material or debris has washed or flowed into or has been placed in existing watercourses, ditches, gutters, drains, pipes, structures, such material or debris shall be entirely removed and satisfactorily disposed of during progress of the work, and the ditches, channels, drains, pipes, structures, and work shall, upon completion of the work, be left in a clean and neat condition.

4. REMOVAL OF TEMPORARY BUILDINGS, STRUCTURES AND EQUIPMENT:

On or before completion of the work, the Contractor shall, unless otherwise specifically directed or permitted in writing, tear down and remove all temporary buildings and structures built by him; shall remove all temporary works, tools and machinery or other construction equipment furnished by him; shall remove all rubbish from any grounds which he has occupied; shall remove silt fences and hay bales used for trapping sediment;

and shall leave the roads and all parts of the property and adjacent property affected by his operations in a neat and satisfactory condition.

5. RESTORATION OF DAMAGED PROPERTY:

The Contractor shall restore or replace, when and as directed, any property damaged by his work, equipment or employees, to a condition at least equal to that existing immediately prior to the beginning of operations. To this end the Contractor shall do as required all necessary highway or driveway, walk and landscaping work. Materials, equipment, and methods for such restoration shall be as approved by the Owner.

6. FINAL CLEANUP:

Before acceptance by the Owner, the Contractor shall perform a final cleanup to bring the construction site to its original or specified condition. This cleanup shall include removing all trash and debris off of the premises. Before acceptance, the condition of the site shall be approved by the Owner.

END OF SECTION

SECTION 02230

CLEARING AND GRUBBING

PART 1- GENERAL

1.01 WORK INCLUDED:

- A. The Contractor shall do all required clearing and grubbing as indicated on the drawings or herein specified in the area required for construction operations on the Owner's land or in the Owner's permanent or temporary easements and shall remove all debris resulting there from.
- B. Unless otherwise noted, all areas to be cleared shall also be grubbed.
- C. The Contractor shall not clear and grub outside of the area required for construction operations.

1.02 RELATED WORK:

Any trees and shrubs specifically designated by the Owner not to be cut, removed, destroyed, or trimmed shall be saved from harm and injury in accordance with Section 01570, ENVIRONMENTAL PROTECTION.

PART 2 - PRODUCTS: NOT APPLICABLE

PART 3 - EXECUTION

3.01 RIGHT TO WOOD AND LOGS:

The Owner shall have the right to cut and remove logs and other wood of value in advance of the Contractor's operations. All remaining logs and other wood to be removed in the course of clearing shall become the property of the Contractor.

3.02 CLEARING:

- A. Unless otherwise indicated, the Contractor shall cut or otherwise remove all trees, saplings, brush and vines, windfalls, logs and trees lying on the ground, dead trees and stubs more than 1-foot high above the ground surface (but not their stumps), trees which have been partially uprooted by natural or other causes (including their stumps), and other vegetable matter such as shags, sawdust, bark, refuse, and similar materials.
- B. The Contractor shall not remove mature trees (4 inches or greater DBH) in the Owner's temporary easements.
- C. Except where clearing is done by uprooting with machinery or where stumps are left longer to facilitate subsequent grubbing operations, trees, stumps, and stubs to be

cleared shall be cut as close to the ground as practicable but not more than 6-inches above the ground surface in the case of small trees, and 12-inches in the case of large trees. Saplings, brush and vines shall be cut close to the ground.

3.03 GRUBBING:

- A. Unless otherwise indicated, the Contractor shall completely remove all stumps and roots to a depth of 18-inches, or if the Contractor elects to grind the stumps, they shall be ground to a minimum depth of 6-inches.
- B. Any depression remaining from the removal of a stump and not filled in by backfilling shall be filled with gravel borrow and/or loam, whichever is appropriate to the proposed ground surface.

3.04 DISPOSAL:

All material collected in the course of the clearing and grubbing which is not to remain shall be disposed of in a satisfactory manner away from the site or as otherwise approved. Such disposal shall be carried on as promptly as possible and shall not be left until the final clean-up period.

END OF SECTION

SECTION 02428

CURED-IN-PLACE PIPE

PART 1 - GENERAL

1.01 WORK INCLUDED:

- A. This section covers installation of cured-in-place pipe as called for herein and on the drawings. The work includes furnishing all equipment, material and labor required to perform the services described herein.

1.02 RELATED WORK:

- A. Section 01014, SCOPE AND SEQUENCE OF WORK
- B. Section 01330, SUBMITTALS
- C. Section 01331, DOCUMENTATION
- D. Section 01575, HANDLING EXISTING FLOWS
- E. Section 02440, SEWER CLEANING AND TELEVISION INSPECTION
- F. Section 02453, SERVICE CONNECTION REHABILITATION

1.03 QUALITY ASSURANCE:

- A. The work described herein shall be performed by a company with not less than five (5) years of experience in providing the required services, employing experienced workers and experienced supervisory personnel. Supervisory personnel shall have not less than three (3) years of experience in providing the required services and shall be present at the jobsite during all work related to the required services.
- B. The Contractor shall have experience installing cured-in-place liners in oval and/or out of round pipe.

1.04 REFERENCES:

The following standards form a part of this specification as referenced:

American Society for Testing and Materials (ASTM)

ASTM F1216 Standard Practice for Rehabilitation of Existing Pipelines and
Conduits by the Inversion and Curing of a Resin-Impregnated Tube

The National Association of Sewer Service Companies (NASSCO)

Performance Specification Guideline for the Installation of Cured-in-Place Pipe (CIPP)

Recommended Specifications for Sewer Collection System Rehabilitation (Current Edition).

1.05 SYSTEM DESCRIPTION:

- A. Unless otherwise indicated herein, installation of cured-in-place pipe shall be carried out in accordance with ASTM F1216, Section 7.
- B. Curing of the liner tube using hot water or steam shall be acceptable.
- C. The Contractor shall design all cured in place liners assuming partially deteriorated pipe conditions and a groundwater height above the crown of the pipe equal to one-half (50%) of the distance between the ground surface and the invert of the sanitary sewer line to be rehabilitated unless otherwise noted below.
- D. The Contractor shall design all cured-in-place structural liners assuming fully deteriorated pipe conditions and a groundwater height above the crown of the pipe equal to one-half (50%) of the distance between the ground surface and the invert of the sanitary sewer line to be rehabilitated unless otherwise noted below
- E. The Contractor may propose alternative cured-in-place processes and/or products for review and approval by the Owner.
- F. The location, length, and approximate interior dimensions of the cured-in-place pipe to be installed are as shown on the drawings.
- G. The Contractor shall provide Material Safety Data Sheets (MSDS) for all chemicals used in the lining process.

1.06 SUBMITTALS: IN ACCORDANCE WITH REQUIREMENTS OF GENERAL SPECIFICATIONS, SUBMIT THE FOLLOWING:

- A. Prior to beginning the work, submit the following:
 - 1. Qualifications of the firm/personnel who will perform the Work.
 - 2. Descriptions of system proposed for handling existing flows, if necessary, during the procedures to be carried out.
 - 3. Description of the system, equipment and material proposed for the cured-in-place pipe.

4. Manufacturer's warranty

- B. Prior to beginning the work, the contractor shall submit, a written plan for contacting homeowners whose service connections may be affected due to the installation of liner. Such plan is subject to approval by the Owner and the Owner.

1.07 WARRANTY:

- A. The cured-in-place pipe shall be warranted against infiltration and defects for one (1) year from the date the project is accepted by the Owner. Defects shall include, but not be limited to, dry spots; lifts; wrinkles; fins; delamination; pinholes (with or without infiltration); mineral deposits; staining; and infiltration. Defects shall also include reinstated non-active service connections and reinstated connections specifically identified on the drawings to not be reinstated.

PART 2 - PRODUCTS

2.01 MATERIALS:

- A. Materials used for the cured-in-place pipe shall meet the requirements of ASTM F1216.
- B. Cured-in-place pipe shall be as manufactured by Insituform Technologies, National Liner, Cure-Line, or approved equal.
- C. Hydrophylic rubber gaskets shall swell to a minimum of 120% of its dry size when in contact with water and shall have a maximum swell size of 6 millimeters high. Gaskets must adhere to the host pipe to ensure proper installation by either an adhesive sealant or mechanical fasteners. Gaskets, fasteners and adhesives shall be as manufactured by Hydrotite, Adeka, LMK Technologies or approved equal.

PART 3 - EXECUTION

3.01 PIPE CLEANING AND INSPECTION:

- A. Pipe cleaning and inspection shall be carried out in accordance with Section 02440, SEWER CLEANING AND INSPECTION and shall not be measured separately for payment.

3.02 FLOW CONTROL:

- A. Flow control, if required, shall be in accordance with Section 01575, HANDLING EXISTING FLOWS.

3.03 WATER FOR CONSTRUCTION PURPOSES:

- A. Availability of water for construction purposes shall be in accordance with Section

01140, SPECIAL PROVISIONS.

3.04 NOTIFICATION:

- A. The Contractor shall affix a written notice to the door of each home that has sewer service through the pipe being lined one week prior to the lining operation and again one day before the lining operation. A notice shall also be distributed following service connection reinstatement stating that the service connection has been restored to service.
- B. The written notice must be approved by the Owner prior to its distribution.
- C. The printing and distribution of notices to the homeowners by the Contractor shall be considered incidental to the lining operation.

3.05 INSTALLATION:

- A. Installation of the cured-in-place pipe shall be in accordance with ASTM F1216, Section 7.
- B. Each sewer segment shall be television inspected prior to the installation of the cured-in-place liner. The inspection shall be performed in “dry-pipe” conditions with no flow in the pipe. The pipe shall be clean and free of all obstructions prior to installation of the liner.
- C. Prior to installation of the cured-in-place pipe the Contractor shall install a hydrophilic rubber gasket on the inside of each pipe where it meets a manhole such that the hydrophilic rubber gasket is between the host pipe and the cured-in-place pipe. The annular space shall be made watertight at the ends of the liner in the manholes.
- D. The Contractor shall install a pre-liner or grout infiltration sources if required to install the cured-in-place pipe.
- E. After the liner has been cured in place, the Contractor shall reinstate all active service connections as directed by the Owner. Branch connections to buildings shall be reinstated to a minimum of 95% of the inside diameter of the existing service connection without excavation, utilizing a remotely controlled cutting device, monitored by a video TV camera. No additional payment will be made for excavations for the purpose of reinstating connections and the contractor will be responsible for all cost and liability associated with such excavation and restoration work.
- F. All reinstated service connections shall be sealed with grout in accordance with Section 02453, SERVICE CONNECTION REHABILITATION. The Contractor shall make certain that the annular space between the host pipe and the cured-in-place pipe is fully sealed with grout. Grouting of reinstated service connections shall be considered incidental to the Cured-in-Place pipe item.
- G. Prior to installation, grouting or other rehabilitation to remove any active infiltration

within the pipeline which may prohibit installation of the cured-in-place pipe shall be considered incidental to the work and shall not be measured separately for payment.

- H. Each sewer segment shall be television inspected after the liner installation. The inspection shall be performed in “dry-pipe” conditions with no flow in the pipe. Post rehabilitation television inspection shall be performed prior to removing any sewer bypass equipment. Post rehabilitation television inspection shall be performed prior to removing any sewer bypass equipment. Post rehabilitation television inspection shall be considered incidental to the lining process and shall not be measured separately for payment.

3.06 TESTING REQUIREMENTS:

- A. Cured-in-place pipe samples shall be prepared and tested by the Contractor in accordance with ASTM F1216 Section 8.1 unless otherwise stated in this section.
- B. The Contractor shall obtain samples for each pipe inversion.
- C. If field conditions or pipe shape prevents the Contractor from obtaining the samples as specified in ASTM 1216 Section 8.1 the samples shall be taken as directed by the Owner.
- D. An independent testing laboratory shall test the cured-in-place pipe samples and the results are to be sent directly to the Owner within 21 calendar days following completion of each inversion.
- E. The cost of obtaining the samples and testing shall be the sole responsibility of the Contractor and shall be considered incidental to the lining process.
- F. Inversions where the cured-in-place pipe samples that do not meet the requirements of ASTM D790 and D638 as indicated in ASTM 1216 Section 8 will be televised by the Contractor, as directed by the Owner, at no additional cost to the Owner, for review by the Owner. Liner deemed unacceptable by the Owner will be removed and replaced at no additional cost to the Owner.

3.07 FIELD TESTING/WARRANTY INSPECTION:

- A. Prior to expiration of the warranty period, during periods of high groundwater, and at a time to be approved by the Owner, the Contractor shall clean and television inspect each of the cured-in-place pipes in accordance with Section 02440, SEWER CLEANING AND TELEVISION INSPECTION. The contractor shall repair any defects found in the cured-in-place pipe. Defects shall include, but not be limited to, dry spots; lifts; wrinkles; fins; delamination; pinholes (with or without infiltration); mineral deposits; staining; and infiltration. Defects shall also include reinstated non-active service connections and reinstated connections specifically identified on the drawings to not be reinstated. Removal and replacement of cured-in-place pipe with defects shall be performed if required by the Owner. Defects shall be repaired by cured-in-place pipe or

short liners, as required by the Owner. Short liners shall be a minimum of four (4) linear feet per defect location. The contractor shall reseal the annular space between the sewer main and the cured-in-place pipe at manhole locations and service connections until there are no visible leaks through television inspection.

- B. Upon approval by the Owner to commence inspection of the cured-in-place pipes as described above in Part A, the Contractor shall have 90 days to complete the cleaning, TV inspection, repair of defects and the reseal of the annular space between the sewer main and the cured-in-place pipe at manhole locations and service connections should leaking be observed during TV inspection.
- C. All inspecting, resealing, cured-in-place lining, short lining or other repairs within the warranty period shall be provided at no additional cost to the Owner.

END OF SECTION

SECTION 02429

CURED-IN-PLACE SHORT LINER

PART 1 - GENERAL

1.01 WORK INCLUDED:

This section covers installation of cured-in-place short liners as called for herein and on the drawings. The work includes furnishing all equipment, material and labor required to perform the services described herein.

1.02 RELATED WORK:

- A. Section 01014, SCOPE AND SEQUENCE OF WORK
- B. Section 01330, SUBMITTALS
- C. Section 01575, HANDLING EXISTING FLOWS
- D. Section 02428, CURED-IN-PLACE PIPE
- E. Section 02440, SEWER CLEANING AND TELEVISION INSPECTION
- F. Section 02453, SERVICE CONNECTION REHABILITATION

1.03 QUALITY ASSURANCE:

The work described herein shall be performed by a company with not less than five (5) years of experience in providing the required services, employing experienced workers and experienced supervisory personnel. Supervisory personnel shall have not less than three (3) years of experience in providing the required services and shall be present at the jobsite during all work related to the required services.

1.04 REFERENCES:

The following standards form a part of this specification as referenced:

American Society for Testing and Materials (ASTM)

ASTM F1216 Standard Practice for Rehabilitation of Existing Pipelines and
Conduits by the Inversion and Curing of a Resin-Impregnated Tube.

The National Association of Sewer Service Companies (NASSCO)

Fiber Spot Repair System Sectional Cured-in-Place Pipe (Amerik Supplies)
Specifications for Cured-in-Place Point Repair (Magnaline Process)

1.05 SYSTEM DESCRIPTION:

- A. The cured-in-place short liners shall be epoxy resin impregnated cured-in-place liners, installed where indicated on the drawings. The short liners shall be thoroughly impregnated with epoxy resin prior to insertion and upon curing shall form a hard, impervious, corrosion resistant lining. When cured, the short liner shall be formed to the internal circumference of the host pipe. The short liner shall be impervious to water and shall not allow infiltration to migrate between the liner and the host pipe at either end of the liner or in the area where a service connection has been reinstated.
- B. The Contractor may propose alternative processes and/or products for review and approval by the Owner.
- C. The Contractor shall design all cured in place short liners assuming partially deteriorated pipe conditions and a groundwater height above the crown of the pipe equal to one-half (50%) of the distance between the ground surface and the invert of the sanitary sewer line to be rehabilitated.
- D. The Contract Drawing Tables define the segments that require a structural short liner and shall be designed assuming "fully deteriorated pipe" conditions as outlined in ASTM F 1216 using a groundwater height above the crown of the pipe equal to one-half (50%) of the distance between the ground surface and the invert of the sanitary sewer line to be rehabilitated:

1.06 SUBMITTALS: IN ACCORDANCE WITH REQUIREMENTS OF GENERAL SPECIFICATIONS, SUBMIT THE FOLLOWING:

- A. Prior to beginning the work, submit one (1) set of the following:
 - 1. Qualifications of the firm/personnel who will perform the Work.
 - 2. Descriptions of system proposed for handling existing flows, if necessary, during the procedures to be carried out.
 - 3. Description of the system, equipment and material proposed for the cured-in-place short liners.
 - 4. MSDS for all chemicals used in the short lining process.
 - 5. Manufacturer's Warranty.

1.07 WARRANTY:

The short liners shall be warranted against infiltration and faulty workmanship and materials for one year from the date the project is accepted by the Owner.

PART 2 - PRODUCTS

2.01 MATERIALS:

Materials used for the cured-in-place short liners shall meet the requirements of ASTM F1216.

PART 3 - EXECUTION

3.01 PIPE CLEANING AND INSPECTION:

Pipe cleaning and inspection shall be carried out in accordance with Section 02440, SEWER CLEANING AND TELEVISION INSPECTION.

3.02 FLOW CONTROL:

Flow control, if required, shall be in accordance with Section 01575, HANDLING EXISTING FLOWS.

3.03 STRUCTURAL REQUIREMENTS:

The design of the cured-in-place short liners shall meet the requirements of ASTM F1216 XI, taking into consideration the condition of the original pipe.

3.04 INSTALLATION:

- A. The cured-in-place short liner installation procedures shall be in accordance with the manufacturer's written instructions, and as herein specified.
- B. The edges of the short liners shall be tapered at both ends.
- C. No significant pipe volume change shall occur due to installation of the short liners.
- D. The short liners shall be installed so as to force excess resin into any cracks, joints or other surface defects of the existing interior pipe wall surface.
- E. Each short liner shall have a minimum length of three (3) linear feet. The short liner shall extend one (1) foot beyond each end of the defect at a minimum. The location and length of the short liners shall be as indicated on the drawings and as directed by the Owner.
- F. After the short liner has been cured in place, the Contractor shall reinstate the existing service connections. Branch connections to buildings shall be reopened without excavation, per ASTM F 1216, paragraph 7.9. No additional payment will be made for excavations for the purpose of reopening connections and the Contractor will be responsible for all costs and liability associated with such excavation and restoration work.
- G. After the existing service connections have been reinstated, the Contractor shall grout the service connections, in accordance with Section 02453, SERVICE CONNECTION REHABILITATION. The Contractor shall make

certain that the annular space between the sewer main and the cured-in-place short liner is fully sealed with grout.

- H. Prior to installation, grouting or other rehabilitation to remove any active infiltration within the pipeline which may prohibit installation of the cured-in-place short liner shall be considered incidental to the work and shall not be measured separately for payment.

3.05 FIELD TESTING/WARRANTY INSPECTION:

- A. Prior to expiration of the warranty period, during periods of high groundwater, and at a time to be approved by the Owner, the Contractor shall television inspect each of the short liners in accordance with paragraph 3.02 of Section 02440, SEWER CLEANING AND TELEVISION INSPECTION.
- B. The Contractor shall repair any defects found and shall seal the annular space between the liner and the host pipe until there are no visible leaks through television inspection.
- C. Upon approval by the Owner to commence inspection of the short liners as described above in Part A, the Contractor shall have 90 days to complete the cleaning, TV inspection, repair of defects and the reseal of the annular space between the sewer main and the cured-in-place pipe at manhole locations and service connections should leaking be observed during TV inspection.
- D. All inspecting and sealing within the warranty period shall be provided at no additional cost to the Owner.

END OF SECTION

SECTION 02435

SEWER MANHOLE REHABILITATION

PART 1 - GENERAL

1.01 WORK INCLUDED:

- A. This Section covers the rehabilitation of sewer manholes as called for herein and on the drawings. It is the intent of this specification to provide for the waterproofing, sealing, and structural enhancement of existing manholes by chemical grout exterior sealing of sewer manhole inverts, walls and corbels; and by application of a uniform cementitious layer of high-quality mortar. Additional manhole rehabilitation related items include manhole root treatment, and install manhole frame and cover.
- B. The work shall include: elimination of infiltration by external chemical grout sealing; removal and patching of loose and/or unsound material; cleaning and preparation of surfaces; repair of invert, bench, and walls; and chemical grout sealing of the invert, bench, walls, and pipe connections; and spray application of a cementitious mix to form a liner. Other repairs shall be completed as indicated on the drawings and described herein.
- C. The contractor shall furnish all equipment, material and labor required to perform all manhole rehabilitations described in this specification.
- D. External grouting of inverts, bench, walls, corbel, and pipe connections shall be performed prior to application of cementitious mix.

1.02 RELATED WORK:

- A. Section 01014, SCOPE AND SEQUENCE OF WORK
- B. Section 01330, SUBMITTALS
- C. Section 01331, DOCUMENTATION
- D. Section 01575, HANDLING EXISTING FLOWS

1.03 QUALITY ASSURANCE:

- A. The work described herein shall be performed by a company with not less than five (5) years of experience in providing the required services, employing experienced workers and experienced supervisory personnel. Supervisory personnel shall have not less than three (3) years of experience in providing the required services and shall be present at the jobsite during all work related to the required services.

1.04 REFERENCES:

The following standards form a part of this specification as referenced:

The National Association of Sewer Service Companies (NASSCO)

Recommended Specifications for Sewer Collection System Rehabilitation (Current Edition).

Performance Specification Guideline for Manhole Rehabilitation

American Society for Testing and Materials (ASTM)

ASTM C94	Ready-Mix Concrete
ASTM C109	Comprehensive Strength
ASTM C267	Chemical Resistance
ASTM C596	Shrinkage
ASTM C666, Method A	Freeze/Thaw Resistance
ASTM D4414	Standard Practice for Measurement of Wet Film Thickness for Organic Coatings
ASTM 543	Resistance of Plastics to Chemical Reagents
ASTM 638	Tensile Properties of Plastic
ASTM 695	Comprehensive Properties of Rigid Plastics
ASTM D790	Flexural Properties of Unreinforced and Reinforced Plastics

1.05 CEMENTITIOUS LINING SYSTEM DESCRIPTION:

- A. Unless otherwise indicated herein, sewer manhole sealing shall be carried out in accordance with the current edition of the NASSCO Performance Specification Guideline for Manhole Rehabilitation.
- B. The Contractor may propose alternative processes and/or products for review and approval by the Owner.
- C. The locations of the cementitious lining work to be completed are as shown on the drawings.

1.06 SUBMITTALS: IN ACCORDANCE WITH REQUIREMENTS OF GENERAL SPECIFICATIONS, SUBMIT THE FOLLOWING:

- A. Prior to beginning the work, submit one (1) set of the following:
 - a. Qualifications of the firm/personnel who will perform the work.
 - b. Provide at least five (5) references of different projects in which at least 50 manholes have been rehabilitated by the firm within the past three (3) years.
 - c. Description of the system, equipment and material with MSDS Data Sheets proposed for sewer manhole rehabilitation.
 - d. Description of the system proposed for bypass pumping during the procedures to be carried out.
 - e. Manufacturer's warranty
- B. Refer to Section 01331, DOCUMENTATION, for required documentation to be submitted.

1.08 WARRANTY:

- A. The manhole rehabilitation work performed shall be warranted against infiltration and faulty workmanship and materials for a period of one (1) year after the project is accepted by the Owner.

PART 2 - PRODUCTS

2.01 REHABILITATION MATERIALS:

All products used for lining, sealing, patching, and cleaning shall be environmentally safe. The contractor shall submit MSDS Data Sheets for all materials used.

2.02 SEALING OF INVERT, STOPPING ACTIVE LEAKS AND EXTERIOR CHEMICAL SEALING:

The contractor shall use a chemical grout that is environmentally safe for the sealing of sewers. The chemical grout shall be in accordance with Part 2, Products, of the Pressure Testing and Grouting of Sewer Joints, Laterals and Lateral Connections (Using the Packer Method with Solution Grouts).

2.03 PATCHING MIX:

A quick-setting cementitious material shall be used as a patching mix and is to be mixed and applied according to the manufacturer's recommendation and shall have the following minimum requirements.

Compressive Strength	ASTM C-109	6 hr 1,400 psi
Shrinkage	ASTM C-596	0% AT 90% Relative Humidity

2.04 INFILTRATION CONTROL MIX:

A rapid-setting cementitious product specifically for leak control shall be used to stop water infiltration and shall be mixed and applied according to the manufacturer's recommendations and shall have the following minimum requirements.

Compressive Strength	ASTM C-109	1 hr 600 psi
Compressive Strength	ASTM C-109	24 hr 1,800 psi

2.05 LINER MIX:

- A. The cementitious liner mix shall be used to form a structural enhancing monolithic liner covering all interior manhole surfaces and shall have the following minimum requirements at 28 days:

Compressive Strength	ASTM C-109	6,000 psi
Shrinkage	ASTM C-596	0%, 90% humidity

Freeze/Thaw Resistance ASTM C-666 No visible damage after 100 cycles

B. The liner mix shall be applied in one monolithic layer.

2.06 BRICK MATERIALS:

- A. Brick shall be sound, hard, and uniformly burned brick, regular and uniform in shape and size, of compact texture, and satisfactory to the Owner. Bricks shall comply with ASTM C32, for Grade SS, hard brick, except that the mean of five tests for absorption shall not exceed 8 percent by weight.
- B. Rejected brick shall be immediately removed from the work and brick satisfactory to the Owner substituted.
- C. Mortar shall be composed of Portland cement, hydrated lime, and sand in which the volume of sand shall not exceed three times the sum of the volumes of cement and lime. The proportions of cement and lime shall be as directed and may vary from 1: 1/4 for dense hard-burned brick to 1:3/4 for softer brick. In general, mortar for Grade SS Brick shall be mixed in the volume proportions of 1: 1/2:4-1/2; Portland cement to hydrated lime to sand.
- D. Cement shall be Type II Portland cement as specified for concrete masonry.
- E. Hydrated lime shall be Type S conforming to ASTM C207.
- F. Sand shall comply with ASTM C 144 specifications for "Fine Aggregate," except that all of the sand shall pass a No.8 sieve.

2.08 CONCRETE:

- A. Cement shall be domestic Portland cement conforming to ASTM C150, Type II.
- B. Fine aggregate shall be washed natural sand conforming to ASTM C33.
- C. Coarse aggregate shall be well graded crushed stone conforming to ASTM C33, size No. 67.
- D. No admixtures shall be used unless approved by the Owner in writing.

2.09 WATER:

Water used in mixing shall be potable.

2.10 DELIVERY, STORAGE, AND HANDLING

- A. Materials shall be delivered to the site in the Manufacturer's original, unopened containers and packaging, with labels clearly identifying product name and manufacturer.
- B. All materials shall be stored properly and in accordance with Manufacturer's instructions.

PART 3 - EXECUTION

3.01 SAMPLING AND TESTING OF LINER:

- A. The Owner reserves the right to test all materials.
- B. Products that fail to meet the requirements of these specifications shall not be incorporated in the work.

3.02 SURFACE PROTECTION:

- A. During progress of work, where appearance is important, adjacent areas or grounds which may be permanently discolored, stained, or otherwise damaged by dust and rebound, shall be adequately protected and, if contacted, shall be cleaned by early scraping, brushing or washing, as the surroundings permit.
- B. No street markings shall be removed or covered throughout the progress of work.

3.03 EXISTING FLOWS:

The Contractor shall divert flows as required for the work and in accordance with the requirements specified in Section 01575, HANDLING EXISTING FLOWS.

3.04 CEMENTITIOUS LINING

A. PREPARATION:

1. Remove all foreign material from the manhole wall and bench using a high-pressure water spray (minimum 5,000 psi). Loose and protruding brick, mortar, and concrete shall be removed using a mason's hammer and chisel and/or scraper. Fill any large voids with quick-setting patching mix. Surfaces to be repaired shall be clean and free of loose materials. Additional surface preparation shall be as recommended by the manufacturer of the materials to be applied.
2. Leaks shall be stopped using a chemical grout, which shall be applied as per the manufacturer's recommendations. Leaks may require weep holes drilled at the manhole base to localize the infiltration during the application, after which the weep holes shall be sealed with a chemical grout and plugged with the quick-setting infiltration control mix prior to the final liner application. Areas with evidence of previous leakage (e.g., mineral deposits) shall also be grouted.
3. All pipe connections in brick and block manholes shall be grouted regardless of whether they are leaking or have signs of previous leakage. Grout ports shall be located near the pipe connections to ensure the sealing material is injected at the manhole/pipe connections. Grout ports shall also be located and drilled in the bench and invert for all brick and block manholes as necessary to seal the manhole base.

B. INVERT SEALING

1. The Contractor shall carry out all work as described in the NASSCO Performance Specification Guideline for Manhole Rehabilitation, Section 3.2C, using sealing materials and procedures accepted by the Owner.
2. A minimum of four (4) grout ports shall be located and drilled in the manhole bench and invert of brick and block manholes as necessary to seal the invert and manhole base.
3. A quick setting patch mix shall be troweled uniformly not to exceed ½-inch, onto the damaged invert extended out onto the base of the manhole sufficiently to tie into the structurally enhanced monolithic liner to be applied.
4. The finished inverts shall create a smooth transition between the manhole invert and cured-in place liner. Application of the quick setting patch mix will not be required in manholes that will have a cured-in-place liner through the invert. The locations are as indicated on the plans.

C. EXTERIOR GROUTING

1. There precast manholes, grout ports shall be located two (2) feet (maximum) around the circumference of the manhole, approximately one (1) foot below and one (1) foot above each joint to seal all joints. Additional grout ports shall be located so as to seal any other defects not occurring at a joint.
2. For brick/block manholes, grout ports shall be located and drilled at 90-degree intervals and every two (2) vertical feet (maximum) around the circumference every two (2) feet (maximum) of the manhole to ensure proper grouting of the soil outside the manhole..
3. The Contractor shall prohibit debris from entering the invert by either covering the invert or plugging during application.
4. The chemical sealing material used shall be as described in chemical sealing (grouting) materials of the Performance Specification for Manhole Rehabilitation (NASSCO).

D. INTERIOR SEALING

1. Interior lining of the manholes shall be conducted only after all other manhole rehabilitations have been completed.
2. Unless otherwise indicated herein, the Contractor shall carry out all work as described in the Performance Specification Guideline for Manhole Rehabilitation, Section 3.2 (NASSCO) using lining materials and procedures accepted by the Owner.

3. Preparation, as described in section 3.05 A, shall be completed prior to the placement of the cementitious liner.
4. Sealant shall not be placed on a frozen surface or during freezing weather. Sealant shall not be placed when it is anticipated that the temperature during the following 24 hours will drop below 32 degrees, Fahrenheit.
5. Pipes and/or service connections shall be temporarily plugged prior to the application of the cementitious manhole interior liner. A flash coat of the liner material shall be applied three (3) inches into each service connection. Temporary plugs shall be removed once the liner has cured sufficiently to prevent erosion of the new liner.
6. Thickness shall be verified with a wet gauge at random points of the new interior surfaces as directed by the Owner. Minimum thickness of one-half (1/2) inch is required.
7. Application shall be with low velocity, continuous flow equipment to prevent the adverse effects of rebound. A smooth trowel finish shall be applied.
8. The Contractor shall prohibit debris from entering the invert by either covering the invert or plugging during application.

3.05 FIELD TESTING/WARRANTY INSPECTION:

- A. Prior to the expiration of the warranty period, the Contractor shall inspect each of the sewer manholes rehabilitated during this project in accordance with Specification for Sewer Manhole Sealing (As provided by NASSCO), Section 7 of the NASSCO Specification Guidelines at a timetable to be approved by the Owner. The Contractor shall repair any defects found until there are no visible leaks.
- B. If the groundwater level is not, in the opinion of the Owner, high enough for an accurate visual inspection, the Contractor shall test a 25% sample of the original manhole rehabilitation work using exfiltration or vacuum methods as described in ASTM C-1244. The manholes in the test sample will be selected and approved by the Owner and will consist of manholes from throughout the project area that are representative of the manhole rehabilitation work originally performed. Any manholes failing the warranty test shall be sealed and retested until the test is passed and/or the results are satisfactory to the Owner.
- C. If the initial failure rate of tested manholes is less than 5%, the work will be considered satisfactory and no further testing will be required.
- D. If the failure rate in the initial test sample equals or exceeds 5%, an additional and equivalent test sample of the original manhole rehabilitation work will be selected and approved by the Owner. Additional test samples shall be taken until the failure rate of less than 5% is met. No previously tested manholes can be included in a subsequent test sample.

- E. Should all of the manhole rehabilitation work fail to meet the less than 5% failure rate in each of the 25% test samples, the Contractor will be required to repeat the inspection procedure following resealing of the structures in question.
- F. Upon approval by the Owner to proceed with Warranty Inspection, the Contractor shall have 90 days to complete the inspection and repair of all manholes inspected as part of the warranty inspection process.
- G. All inspecting, testing, and reworking within the warranty period shall be provided at no additional cost to the Owner.

END OF SECTION

SECTION 02437

SEWER LINE AND MANHOLE CHEMICAL ROOT TREATMENT

PART 1 - GENERAL

1.01 WORK INCLUDED:

- A. This Section covers chemical root treatment of sewer lines and manholes as called for herein and on the drawings. The work includes furnishing all equipment, material and labor required to perform the services described herein.

1.02 RELATED WORK:

- A. Section 01014, SCOPE AND SEQUENCE OF WORK
- B. Section 01330, SUBMITTALS
- C. Section 01331, DOCUMENTATION
- D. Section 01575, HANDLING EXISTING FLOWS
- E. Section 02435, SEWER MANHOLE REHABILITATION
- F. Section 02440, SEWER CLEANING AND INSPECTION

1.03 QUALITY ASSURANCE:

- A. The work described herein shall be performed by a company with not less than five (5) years of experience in providing the required services, employing experienced workers and experienced supervisory personnel. Supervisory personnel shall have not less than three (3) years of experience in providing the required services and shall be present at the jobsite during all work related to the required services.

1.04 REFERENCES:

The following standards form a part of this specification as referenced:

The National Association of Sewer Service Companies (NASSCO)

Sewer Line Chemical Root Control – Technical Specifications (Duke’s Root Control)
Foaming Root Control Herbicide – Technical Specifications (Vaporooter)

1.05 SYSTEM DESCRIPTION:

- A. Unless otherwise indicated herein, chemical root treatment of the specified lengths of pipe and manholes shall be carried out in accordance with Foaming Root Control Herbicide – Technical Specifications (Vaporooter) of the NASSCO Specification Guidelines.
- B. The Contractor may propose alternative processes and/or products for review and approval by the Engineer.

1.06 SUBMITTALS: IN ACCORDANCE WITH REQUIREMENTS OF SECTION 01330 SUBMITTALS, SUBMIT THE FOLLOWING:

- A. Prior to beginning the work, submit the following:
 - 1. Qualifications of the firm/personnel who will perform the work.
 - 2. Description of system proposed for handling existing flows, if necessary, during the procedures to be carried out.
 - 3. Description of the system, equipment and material proposed for root treatment and cleaning of the pipe and manholes, including MSDS Data Sheets for all chemicals intended to be used.
 - 4. Manufacturer's warranty.
 - 5. Copy of MWRA Root Control Request Permit in accordance with Section 00890, PERMITS.

1.07 WARRANTY:

- A. The Contractor shall provide a written guarantee that meets or exceeds any claims or warranties made by the manufacturer in published advertising. As a minimum, the Contractor shall guarantee that, prior to scheduled cleaning, virtually all root tissue present in the sewer pipe will be dead or unable to sustain life.

PART 2 - PRODUCTS

2.01 ROOT TREATMENT MATERIALS:

- A. The chemical root treatment material shall be EPA registered and labeled for use in sewer lines and acceptable to the state agencies having jurisdiction over its use. The Contractor shall submit a specimen product label of the material to be used in chemical root treatment to the Engineer. The chemical root treatment material shall not permanently affect parts of trees distant from the treated roots.
- B. Materials shall meet the requirements of the Foaming Root Control Herbicide – Technical Specifications (Vaporooter) of the NASSCO Specification Guidelines.

PART 3 - EXECUTION

3.01 ROOT TREATMENT:

- A. The Contractor shall carry out all preparatory work, including flow control, and apply root treatment as described in the Foaming Root Control Herbicide – Technical Specifications (Vaporooter) of the NASSCO Specification Guidelines, using treatment materials accepted by the Engineer.

3.02 ROOT CLEANING:

- A. Root cleaning shall be carried out under Section 02440, SEWER CLEANING, INSPECTION, TESTING AND SEALING.

END OF SECTION

SECTION 02440

SEWER CLEANING AND INSPECTION

PART 1 - GENERAL

1.01 WORK INCLUDED:

- A. This section covers cleaning and inspection of pipelines as called for herein and on the drawings. The work includes furnishing all equipment, material and labor required to perform the services described herein.

1.02 RELATED WORK:

- A. Section 01330, SUBMITTALS
- B. Section 01331, DOCUMENTATION
- C. Section 01575, HANDLING EXISTING FLOWS
- D. Section 02428, CURED-IN-PLACE PIPE
- E. Section 02429, CURED-IN-PLACE SHORT LINER
- F. Section 02437, SEWER LINE AND MANHOLE CHEMICAL ROOT TREATMENT
- G. Section 02453, SERVICE CONNECTION REHABILITATION

1.03 QUALITY ASSURANCE:

- A. The work described herein shall be performed by a company with not less than five (5) years of experience in providing the required services, employing experienced workers and experienced supervisory personnel. Supervisory personnel shall have not less than three (3) years of experience in providing the required services and shall be present at the jobsite during all work related to the required services.

1.04 REFERENCES:

The following standards form a part of this specification as referenced:

The National Association of Sewer Service Companies (NASSCO)

Recommended Specifications for Sewer Collection System Rehabilitation (Current Edition).

1.05 SYSTEM DESCRIPTION:

- A. Unless otherwise indicated herein, the pipe cleaning, inspection, testing and sealing of the specified length of pipe shall be carried out in accordance with Section 3, Execution, of the latest edition of NASSCO Suggested Standard Specification for Pressure Testing and Grouting of Sewer Joints, Laterals and Lateral Connections (Using the Packer Method with Solution Grouts). Sewer flow control shall comply with Section 01575, HANDLING OF EXISTING FLOWS. Sealing materials shall comply with Part 2, Products, of the NASSCO Suggested Standard Specification for Pressure Testing and Grouting of Sewer Joints, Laterals and Lateral Connections (Using the Packer Method with Solution Grouts).
- B. The Contractor may propose alternative processes and/or products for review and approval by the Owner.

1.06 SUBMITTALS: IN ACCORDANCE WITH REQUIREMENTS OF GENERAL SPECIFICATIONS, SUBMIT THE FOLLOWING:

- A. Prior to beginning work, submit one (1) set of the following:
 - 1. Qualifications of the firm/personnel who will perform the work.
 - 2. Description of system proposed for handling existing flows during the various procedures to be carried out.
 - 3. Description of the system and equipment proposed for cleaning the pipe.
 - 4. Description of the equipment and system proposed for inspecting the pipe after cleaning.
 - 5. Proof of NASSCO Pipeline Assessment and Certification Program (PACP) certifications for personnel performing the pipeline inspection.
- B. Refer to Section 01331, DOCUMENTATION for required documentation to be submitted.

PART 2 - EXECUTION

2.01 PIPE CLEANING:

- A. The Contractor may elect to use either high velocity jet, or mechanically powered equipment, as described in the NASSCO Standard Specifications. Selection of equipment shall be based upon field conditions such as access to manholes, quantity of debris, size of sewer, depth of flow, etc.
- B. All sludge, dirt, sand, rocks, grease, and other solid or semisolid material resulting from the cleaning operation shall be disposed of in accordance with all applicable regulations and in a method acceptable to the Owner. Pipe cleaning shall be performed in advance of pipe television inspection.

- C. The Contractor shall be responsible for the legal disposal of all debris removed from the sewers during the cleaning operation including any costs incurred. The Contractor shall not expect the Owner to provide a dump site.
- D. The Contractor shall perform light cleaning of the sewer prior to television inspection. Heavy cleaning shall not be performed. Light cleaning shall include a minimum of 2 passes with either high velocity jet, or mechanically powered equipment, as described in the NASSCO Standard Specifications. The Contractor shall maintain a list of line segments that require additional cleaning. The list shall detail the reason additional cleaning is required (e.g. sediment, roots, grease, etc.).
- E. The Contractor shall perform heavy cleaning of the sewer only when specifically authorized by the Owner. Heavy cleaning is to be performed and paid in addition to the appropriate item for light cleaning of sewers requiring cleaning in addition to the two (2) passes included in light cleaning of sewers. Heavy cleaning shall include the cleaning and removal of sediments and tuberculation up to a depth of $\frac{1}{4}$ the diameter of the pipe. Sediment and tuberculation depths in excess of $\frac{1}{4}$ the diameter of the pipe shall not be paid under these items. The sewer heavy cleaning work, by-pass pumping, plugging or blocking of sewer flow, and the storage, testing and disposal of any material retrieved from sewer cleaning shall be considered incidental to the work and shall not be considered separately for payment.

2.02 PIPE INSPECTION:

- A. Pipe shall be visually inspected by means of closed-circuit television. The television camera used for the inspection shall be one specifically designed and constructed for such inspection. Lighting for the camera shall be suitable to allow a clear picture, with minimal reflective glare, for the entire periphery of the pipe. The camera shall be operative in 100% humidity conditions. The camera, television monitor and other components of the video system shall be capable of producing a minimum 400 line resolution color video picture. Picture quality and definition shall be to the satisfaction of the Engineer.
 - 1. Refer to Section 01331, DOCUMENTATION, in regard to external hard drives to be given to the Owner upon completion of project and before the project is accepted by the Owner.
- B. The camera shall have a remote controlled, pan and tilt type lens and lighting system capable of turning perpendicular to the direction of flow and rotating 360 degrees while inside the pipe. The camera shall be able to view a minimum service connection length of 4 feet in order to determine whether the connection is active or inactive.
- C. Electronic video equipment shall be capable of displaying and recording during the entire inspection, as a minimum, the following data for each sewer reach videotaped.
 - 1. Project identification
 - 2. Date recorded
 - 3. Sewer reach identification (street location, MH to MH)

4. Footage counter

- D. All television inspection shall be originally captured and recorded in the following (minimum):
- File Format: MPEG-4 (.mp4)
 - Codec: AVC (H.264)
 - Frame Size 16/9: 1280 x 720 OR 4/3: 960 x 720
 - Frame Rate: 60 fps
 - Pixel Aspect Ratio 1:1 (square pixels)
 - Video Standard: NTSC
 - Scan Type: Progressive
- E. Inspections shall be recorded one at a time, with each segment recorded as a separate file on the external hard drive.
- F. The camera shall be moved through the line in either direction at a uniform rate, stopping when necessary to ensure proper identification of the sewer's condition. Manual winches, power winches, TV cable and powered rewinds or other devices that do not obstruct the camera view or interfere with proper NASSCO PACP documentation of the sewer conditions shall be used to move the camera through the sewer line. If, during the inspection operation the television camera will not pass through the entire sewer section, the Contractor shall re-set his equipment in a manner so that the inspection can be performed from the opposite manhole.
- C. The camera shall be moved through the sewer line at a prudent rate so that all pipe leaks and defects are observed and recorded. The Contractor shall estimate, by direct observation, the discharge rate in gallons per minute (GPM) of all continuously running service connections, and leakage into the pipe and manholes. Pipelines shall also be classified in accordance with NASSCO PACP standards and classification. Infiltration from service lines shall be differentiated from infiltration at service connections. The Contractor shall determine and document the street address of those buildings, which connect to the continuously running service connections and shall attempt to determine whether observed flow is from usage or infiltration. The discharge rates of all sources of leakage shall be reported as a single value; a range of values for each source will not be accepted. The Contractor shall also record defects that do not show signs of leakage, including; roots, cracks, offset or broken joints, sags in line, etc.
- G. Flow control shall be in accordance with Section 01575, HANDLING OF EXISTING FLOWS. When upstream sewers are plugged, the Contractor shall monitor the extent of surcharging and will ensure that the surcharge does not result in overflows from manholes or backups into the basements of buildings.
- H. Standing water within a sagging pipe shall be removed so that the pipe can be adequately television inspected. A minimum of 80% of the pipe shall be visible before television inspection.

- I. Documentation of the sewer conditions shall conform to the NASSCO PACP protocol. Personnel shall be NASSCO PACP certified.

END OF SECTION

SECTION 02451

UNIFORMED OFFICERS FOR TRAFFIC CONTROL

PART 1 - GENERAL

1.02 WORK INCLUDED:

- A. This Section covers the provisions for furnishing Uniformed Officers for Traffic Control and Maintenance of Traffic as described in Section 01110 CONTROL OF WORK AND MATERIALS.

1.02 DESCRIPTION:

- C. The Contractor shall coordinate with the local jurisdictions Traffic Control Officer to determine the number of Officers deemed necessary to provide for public safety and to maintain a smooth flow of traffic through the construction area(s) effected.

1.03 RELATED WORK:

- B. SECTION 01550, SIGNAGE (TRAFFIC CONTROL)
- B. SECTION 01110, CONTROL OF WORK AND MATERIALS (MAINTENANCE OF TRAFFIC)

PART 2 - PRODUCTS

2.01 UNIFORMED OFFICERS:

- A. Contractor shall provide the Traffic Control Officer with a minimum of 24 hours' notice indicating the time of day, street location and confirm number of officers required for traffic control.
- C. Contractor shall give the Traffic Control Officer a minimum of 4 hours prior cancellation notice should Contractor determine that due to weather or conditions beyond his control he would not need the scheduled officers.
- C. Where the Owner is paying directly for Traffic Officers and the Contractor cancels scheduled officers, the Contractor shall be responsible for payment of the wages for cancellations if not cancelled in accordance with 2.01.B above.

PART 3 - EXECUTION

3.01 OPERATION:

- A. Contractor shall provide barricades, barrier fences, traffic signs, and other traffic control devices as required by the Owners Traffic Control Officer, or as directed by the Owner, to protect the work area from traffic, pedestrians, and animals.

- B. Contractor shall relocate barricades, signs and other devices as necessary as the work progresses as directed by the Owners Traffic Control Officer or the Owner.

END OF SECTION

SECTION 02453

SERVICE CONNECTION REHABILITATION

PART 1 - GENERAL

1.01 WORK INCLUDED:

- A. This Section covers the rehabilitation of service connections, including cutting of protruding services, television inspection and testing of services, and grouting of services as called for herein and on the drawings. The work includes furnishing all equipment, material and labor required to perform the services described herein.

1.02 RELATED WORK:

- A. Section 01330, SUBMITTALS
- B. Section 01331, DOCUMENTATION
- C. Section 01575, HANDLING EXISTING FLOWS
- D. Section 02428, CURED-IN-PLACE PIPE
- E. Section 02429, CURED-IN-PLACE SHORT LINER
- F. Section 02440, SEWER CLEANING AND INSPECTION

1.03 QUALITY ASSURANCE:

- A. The work described herein shall be performed by a company with not less than five (5) years of experience in providing the required services, employing experienced workmen and experienced supervisory personnel. Supervisory personnel shall have not less than three (3) years of experience in providing the required services and shall be present at the jobsite during all work related to the required services.

1.04 REFERENCES:

The following standards form a part of this specification as referenced:

The National Association of Sewer Service Companies (NASSCO)

Suggested Standard Specification for Pressure Testing and Grouting of Sewer Joints, Laterals and Lateral Connections (Using the Packer Method with Solution Grouts)

American Society of Testing and Materials (ASTM)

ASTM F2454 Standard Practice for Sealing Lateral Connections and Lines from the Mainline Sewer Systems by the Lateral Packer Method, Using Chemical Grouting

1.05 SYSTEM DESCRIPTION:

- A. Unless otherwise indicated herein, service connection rehabilitation shall be carried out in accordance with Lateral Connection Sealing from the Mainline by Packer Injection Grouting, Section 3.10, of the NASSCO Suggested Standard Specification for Pressure Testing and Grouting of Sewer Joints, Laterals and Lateral Connections (Using the Packer Method with Solution Grouts).
- B. The Contractor may propose alternative processes and/or products for review and approval by the Engineer.
- C. The location of the service connection rehabilitations are indicated on the drawings.

1.06 SUBMITTALS: IN ACCORDANCE WITH REQUIREMENTS OF SECTION 01330 SUBMITTALS, SUBMIT THE FOLLOWING:

- A. Prior to beginning the work, submit the following:
 - 1. Qualifications of the firm/personnel who will perform the work.
 - 2. Descriptions of system proposed for handling existing flows, if necessary, during the procedures to be carried out.
 - 3. Description of the system, equipment and material proposed for the service connection rehabilitations.
 - 4. Manufacturer's warranty.
 - 5. Submit MSDS Data Sheets for proposed chemicals to be used.
- B. Refer to Section 01331, DOCUMENTATION, for documentation required to be submitted.

1.07 WARRANTY:

- A. The service connection rehabilitations shall be warrantied against infiltration and faulty workmanship and materials for one year from the date the project is accepted by the Owner.

PART 2 - PRODUCTS

2.01 CHEMICAL GROUT:

- A. The Contractor shall use chemical grout which is environmentally safe for the sealing of sewers. The chemical sealing materials shall be used in accordance with Part 2, Products, of the latest edition of NASSCO Suggested Standard Specification for Pressure Testing and Grouting of Sewer Joints, Laterals and Lateral Connections (Using

the Packer Method with Solution Grouts). All other products used for sealing, patching and cleaning of sewers shall also be environmentally safe.

PART 3 - EXECUTION

3.01 PIPE CLEANING AND INSPECTION:

- A. Pipe cleaning and inspection shall be carried out in accordance with Section 02440, SEWER CLEANING, INSPECTION, TESTING AND SEALING.

3.02 FLOW CONTROL:

- A. Flow control, if required, shall be in accordance with Section 01575, HANDLING EXISTING FLOWS.

3.03 CUTTING OF PROTRUDING SERVICE CONNECTIONS:

- A. The Contractor shall cut protruding service connections where called for on the drawings. The protruding services shall be cut flush with the wall of the sewer, using either a lateral cutter or grinder.
- B. After the protruding services are cut, the service connections shall be grouted in accordance with paragraph 3.06 of this Section. No additional payment shall be made for grouting service connections.

3.04 EQUIPMENT TESTING:

- A. The Contractor shall perform an above ground demonstration test in a test cylinder with the same diameter as the proposed pipe being tested to simulate a pipe leak. The setup shall have a valve and pressure gauge to simulate leaks and monitor pressure. The tests shall be performed in accordance with the latest edition of ASTM F2454, Standard Practice for Sealing Lateral Connections and Lines from the Mainline Sewer Systems by the Lateral Packer Method, Using Chemical Grouting, Section 11.3.3, Initial Testing.
- B. The pressure displayed by the testing equipment shall be within ± 0.5 psi of the gauge pressure to pass successfully. The void pressure should drop to within ± 0.5 psi of the pre-test pressure displayed by the testing equipment after the pressure is released to pass successfully. Test pressures shall be between 7 and 10 psi.
- C. If the demonstration test cannot be performed successfully, the Contractor shall repair or modify the equipment and perform the test again until the results are satisfactory to the Engineer
- D. The Contractor shall perform the demonstration test for each chemical sealing unit prior to the equipment being used on the Project. Additional tests may be required by the Engineer at various times during the Project.

3.05 TELEVISION INSPECTION AND TESTING OF SERVICE CONNECTIONS:

- A. The Contractor shall television inspect and test service connections where called for on the drawings. Television inspection of services shall utilize a pan and tilt camera which shall inspect a minimum of 4 feet of the service connection from the main sewer.
- B. Pressure Testing: Air testing is accomplished by isolating the area to be tested with the packer and applying positive pressure into the isolated VOID area. VOID area shall include a minimum 3 feet of service connection pipe.
- C. Pressure testing shall be carried out in accordance with Section 3.7, Lateral Connection Testing Procedure, of the latest edition of NASSCO Suggested Standard Specification for Pressure Testing and Grouting of Sewer Joints, Laterals and Lateral Connections (Using the Packer Method with Solution Grouts).
- D. Pressure testing shall be equal to 0.5 psi per vertical foot of pipe depth plus 2 psi; however, test pressure shall not exceed 10 psi. Once the designated pressure in the isolated void is displayed on the meter of the control panel, the application of air pressure will be stopped and a 15 second waiting period will commence. If the void pressure drop is greater than 2.0 psi within 15 seconds, the lateral shall be considered to have failed the air test.
- E. The television inspection and testing equipment shall be capable of inspecting and testing 4-inch, 5-inch and 6-inch diameter service connections.
- F. If the service fails the pressure test, the service shall be grouted in accordance with paragraph 3.06 of this Section and retested.

3.06 GROUTING OF SERVICE CONNECTIONS:

- A. The Contractor shall grout service connections where indicated on the drawings or when a service fails the pressure test, as described in paragraph 3.05 of this Section. The Contractor shall grout all service connections reinstated as described in Section 02428, CURED-IN-PLACE PIPE or Section 02429, CURED-IN-PLACE SHORT LINER, regardless of the results of the pressure test. Grouting of service connections shall be carried out in accordance with Section 3.10, Lateral Connection Sealing from the Mainline by Packer Injection Grouting, of the NASSCO Suggested Standard Specification for Pressure Testing and Grouting of Sewer Joints, Laterals and Lateral Connections (Using the Packer Method with Solution Grouts).
- B. When pumping grout commences, operate the pump until a minimum back pressure of 8 psi is achieved.
- C. The grouting equipment shall be capable of grouting 4-inch, 5-inch and 6-inch diameter service connections.
- D. The chemical sealing materials shall be as described in Part 2, Products of the latest edition of NASSCO Suggested Standard Specification for Pressure Testing and Grouting of Sewer Joints, Laterals and Lateral Connections (Using the Packer Method with Solution Grouts).

- E. If a service connection becomes clogged with grout, the Contractor shall clear the grout from the lateral. This work shall be done at no additional cost to the Owner.

3.07 FIELD TESTING/INSPECTION:

- A. Prior to the expiration of the warranty period, an initial test sample of approximately 10% of the original service connection rehabilitation work will be selected and approved by the Engineer. The test sample will consist of manhole sections from throughout the project area that are representative of the sealing work originally performed. The Contractor shall television inspect and test all previously grouted service connections within the initial test sample as specified in paragraph 3.05 of this Section. Any service connections failing the re-test shall be re-grouted as specified in paragraph 3.06 of this Section. If the failure rate in the initial test sample is less than 10%, the work will be considered satisfactory and no further testing will be required.
- B. If the failure rate in the initial test sample equals or exceeds 10%, an additional 15% test sample will be selected and approved by the Engineer. If the failure rate in the additional test sample is less than 10%, the work will be considered satisfactory and no further testing will be required. No previously tested service connection can be included in the additional test sample.
- C. If the failure rate in the additional test sample equals or exceeds 10%, the Contractor shall television inspect and test 100% of the service connections.
- D. Any remaining service connection rehabilitation work not television inspected and tested as part of a test sample shall be television inspected. The Contractor shall repair any defects found and shall re-grout the services until there are no visible leaks through television inspection.
- E. Television inspecting, testing, and re-grouting of service connections shall be performed prior to the expiration of the warranty period, during periods of high groundwater and at a time to be approved by the Engineer.
- F. All inspecting, re-testing, and re-grouting shall be provided at no additional cost to the Owner and shall be completed within the warranty re-test period.

END OF SECTION

2021 Sewer Rehab Map Map 1



TOWN OF DEDHAM
Norfolk County
Massachusetts

1 inch = 150 feet

Legend

Action

- Manhole Rehab
- Cured in Place - Long Liner
- Cured in Place - Short Liner
- Sewer Manholes
- Sewer Pressurized Mains
- Sewer Gravity Mains
- Sewer Stubs

Locus Map

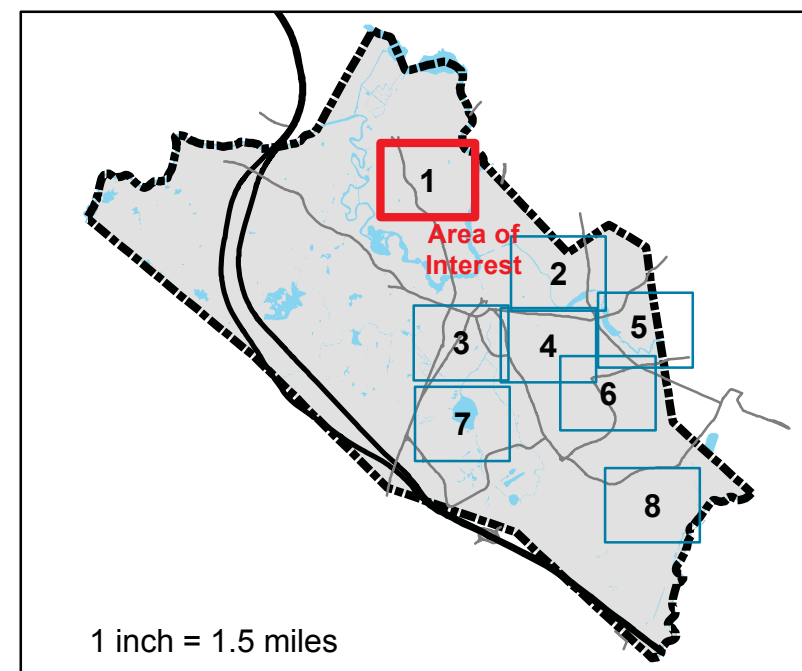

This document is intended for
Town of Dedham planning and
analysis purposes only.

Produced by:
The Town of Dedham
Engineering Department

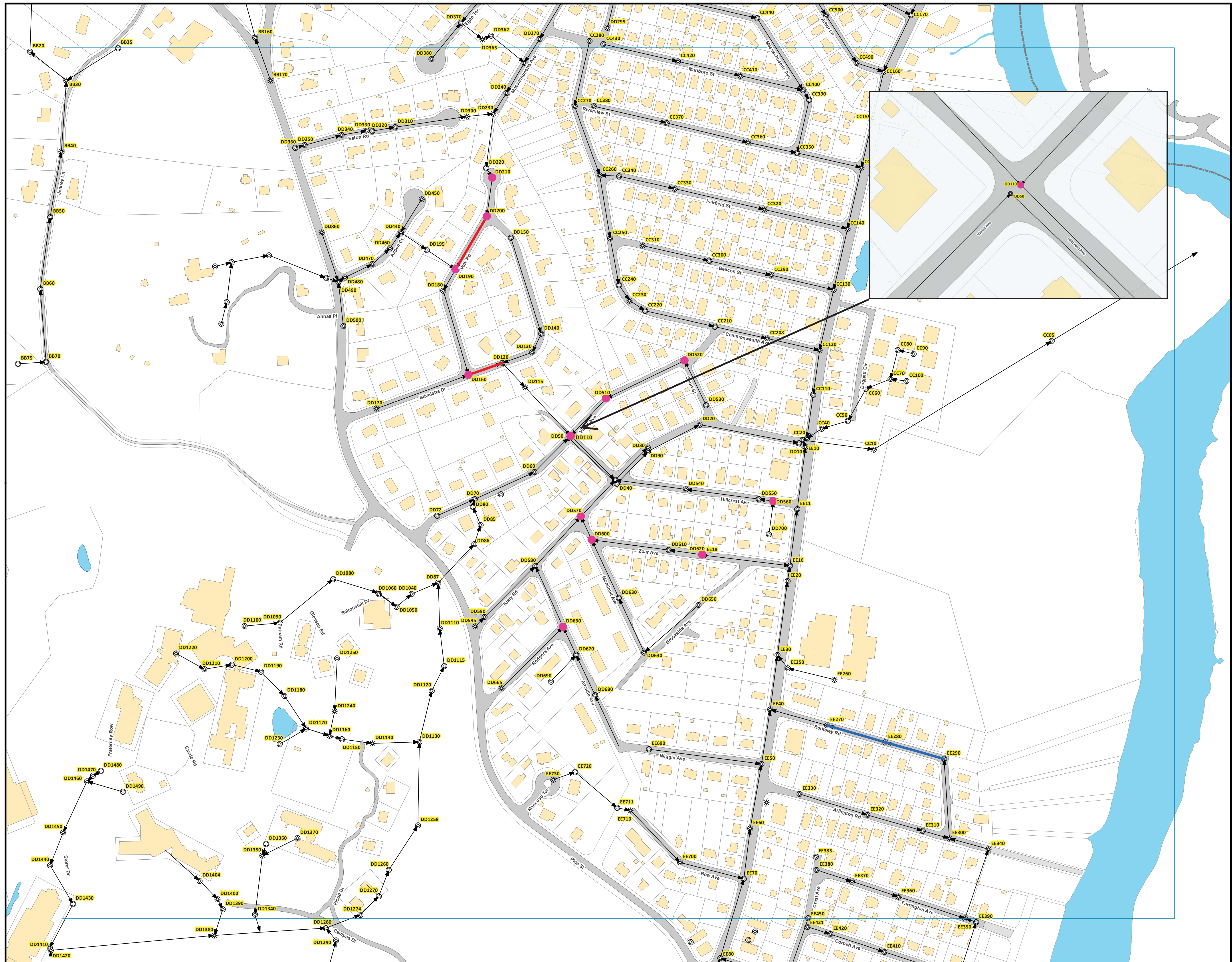

2021 Sewer Rehab Map

Map 2



TOWN OF DEDHAM
Norfolk County
Massachusetts

1 inch = 150 feet

Legend

- Action**
- Manhole Rehab
 - Action**
 - Cured in Place - Long Liner
 - Cured in Place - Short Liner
 - Sewer Manholes
 - Sewer Pressurized Mains
 - Sewer Gravity Mains
 - Sewer Stubs

Locus Map

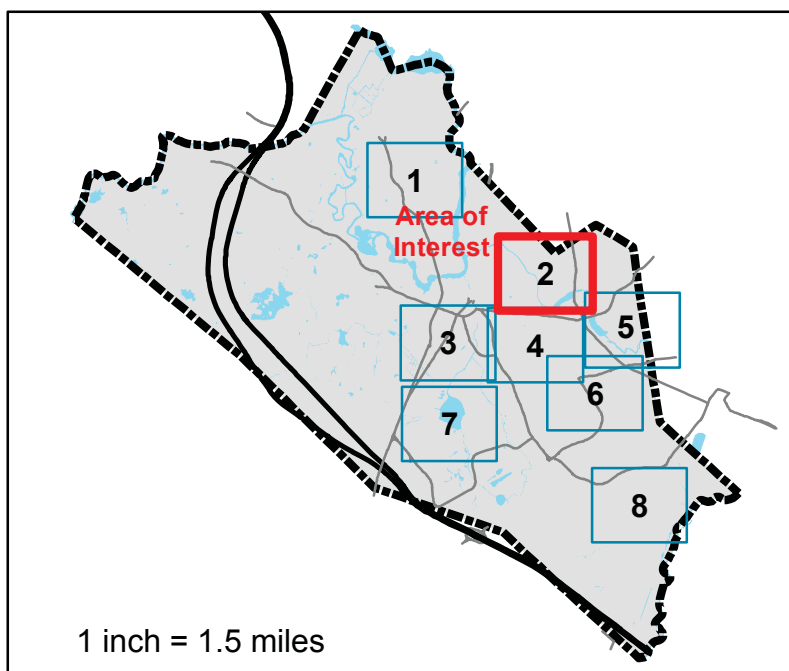

This document is intended for
Town of Dedham planning and
analysis purposes only.

Produced by:
The Town of Dedham
Engineering Department

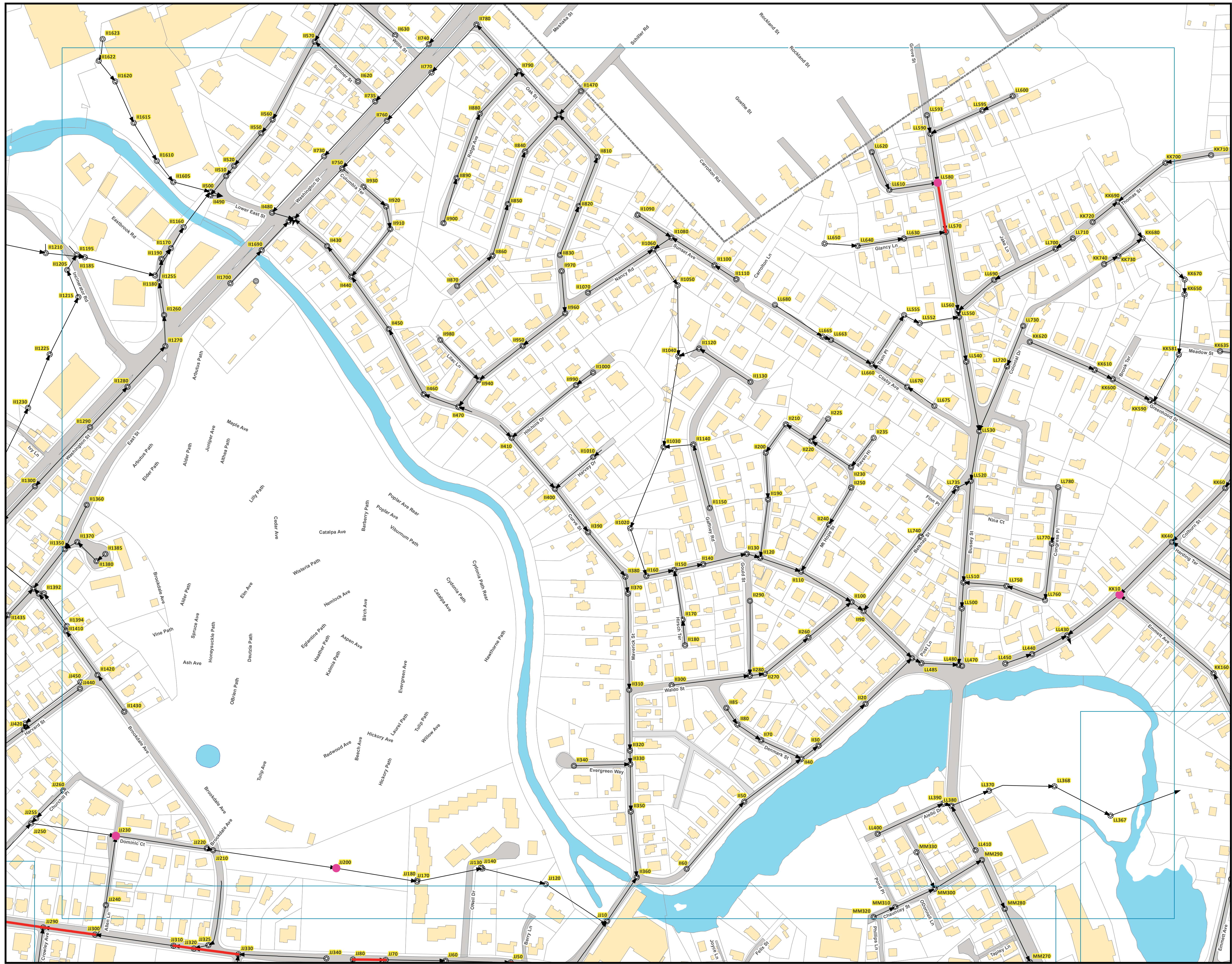

2021 Sewer Rehab Map

Map 3



TOWN OF DEDHAM
Norfolk County
Massachusetts

1 inch = 150 feet

Legend

- Action**
- Manhole Rehab
 - Cured in Place - Long Liner
 - Cured in Place - Short Liner
 - Sewer Manholes
 - Sewer Pressurized Mains
 - Sewer Gravity Mains
 - Sewer Stubs

Locus Map

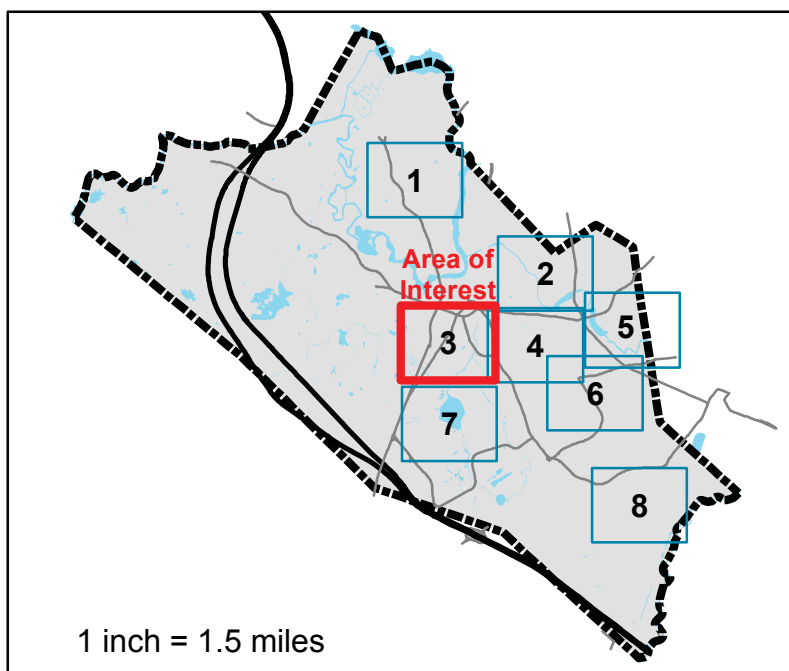

This document is intended for
Town of Dedham planning and
analysis purposes only.

Produced by:
The Town of Dedham
Engineering Department

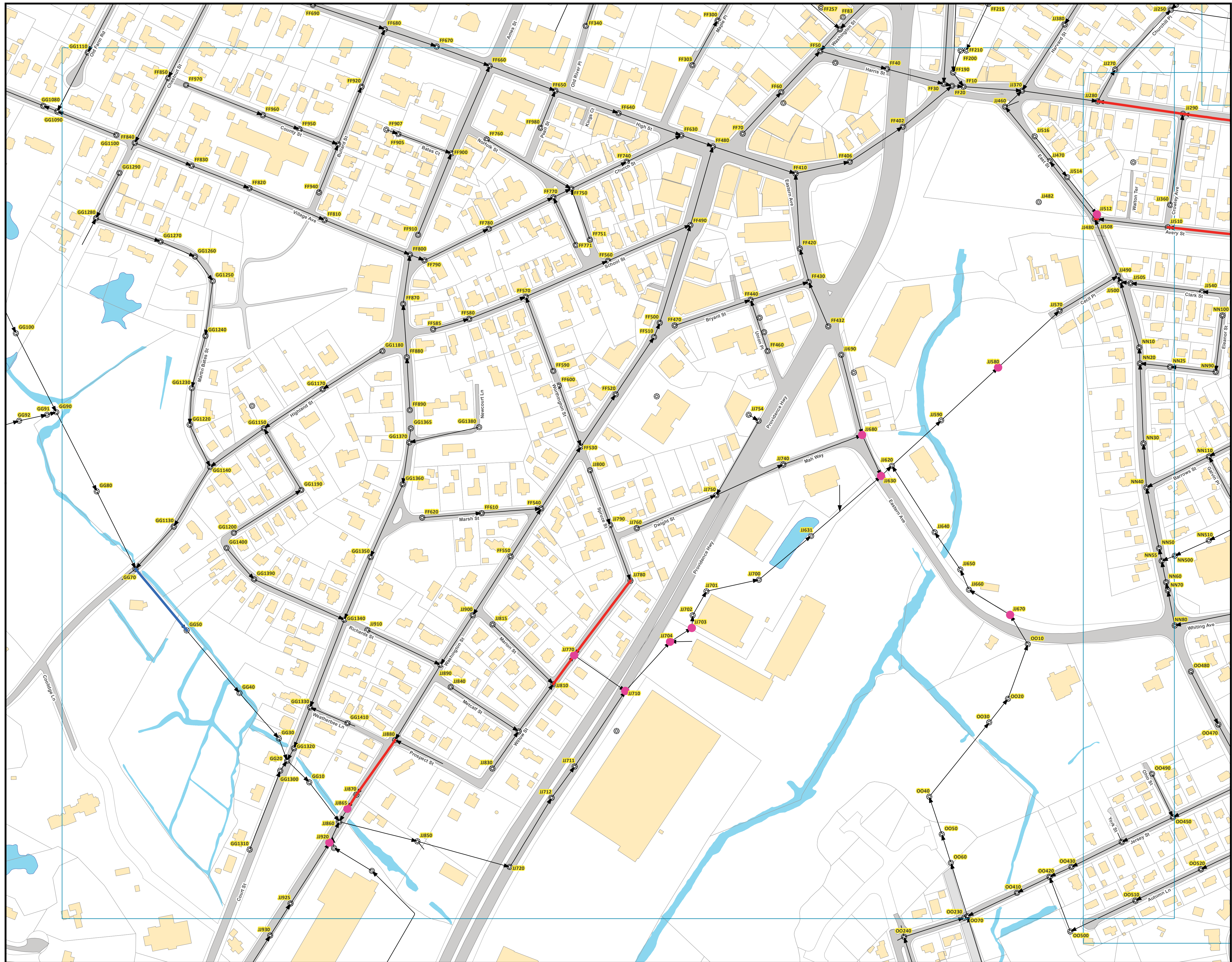

2021 Sewer Rehab Map

Map 4



TOWN OF DEDHAM
Norfolk County
Massachusetts

1 inch = 150 feet

Legend

Action

- Manhole Rehab
- Cured in Place - Long Liner
- Cured in Place - Short Liner
- Sewer Manholes
- Sewer Pressurized Mains
- Sewer Gravity Mains
- Sewer Stubs

Locus Map

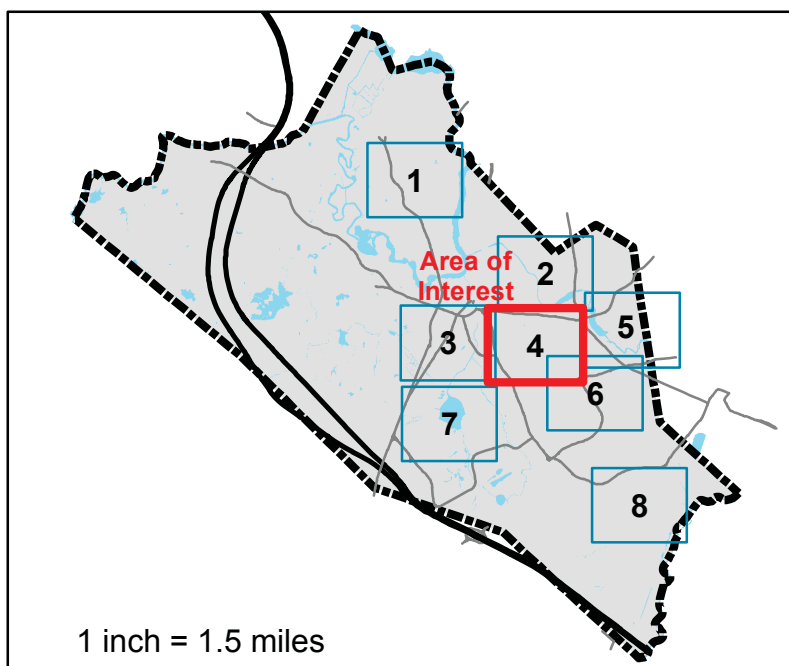

This document is intended for
Town of Dedham planning and
analysis purposes only.

Produced by:
The Town of Dedham
Engineering Department

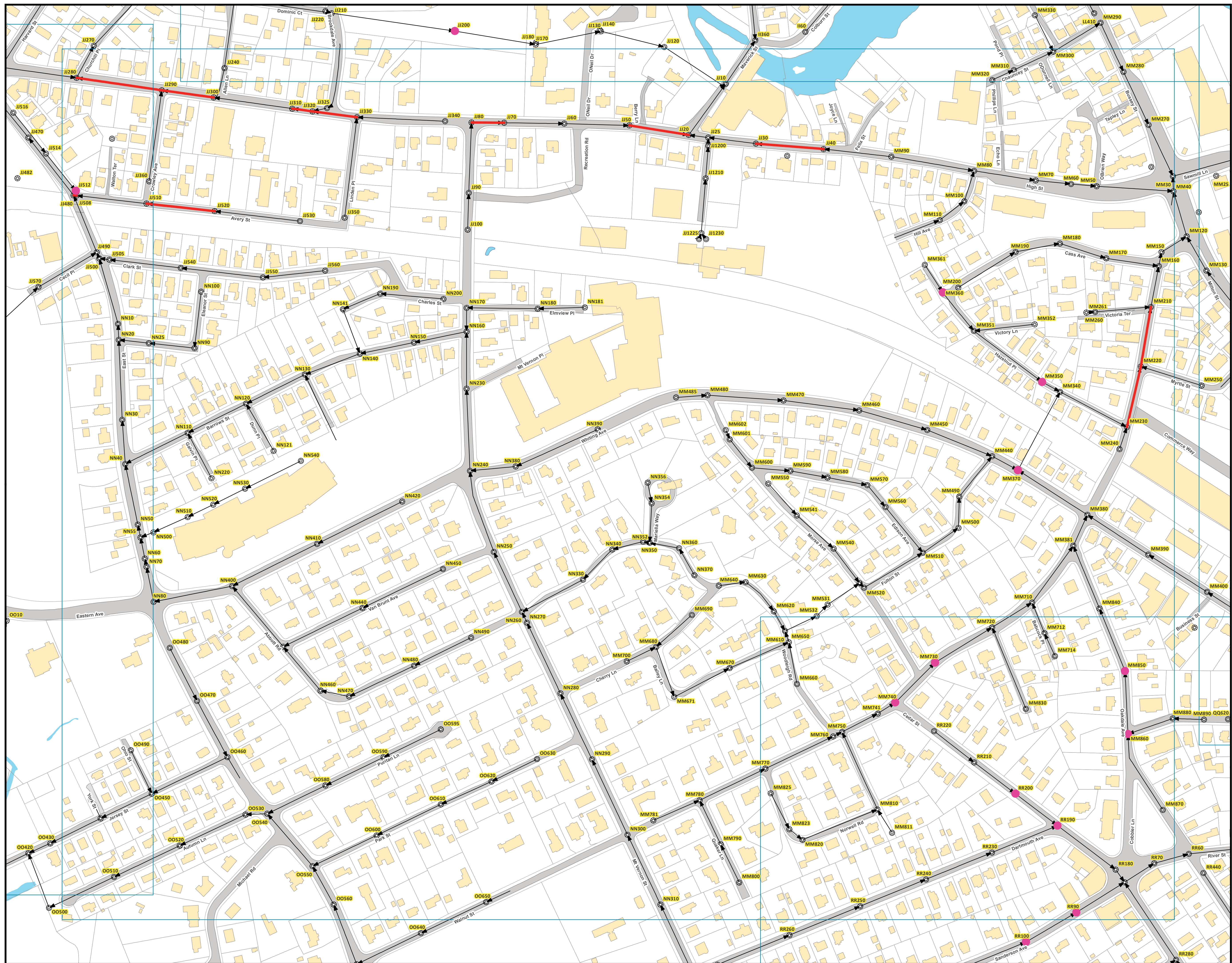

2021 Sewer Rehab Map

Map 5



TOWN OF DEDHAM
Norfolk County
Massachusetts

1 inch = 150 feet

Legend

Action

- Manhole Rehab
- Action**
- Cured in Place - Long Liner
- Cured in Place - Short Liner
- Sewer Manholes
- Sewer Pressurized Mains
- Sewer Gravity Mains
- Sewer Stubs

Locus Map

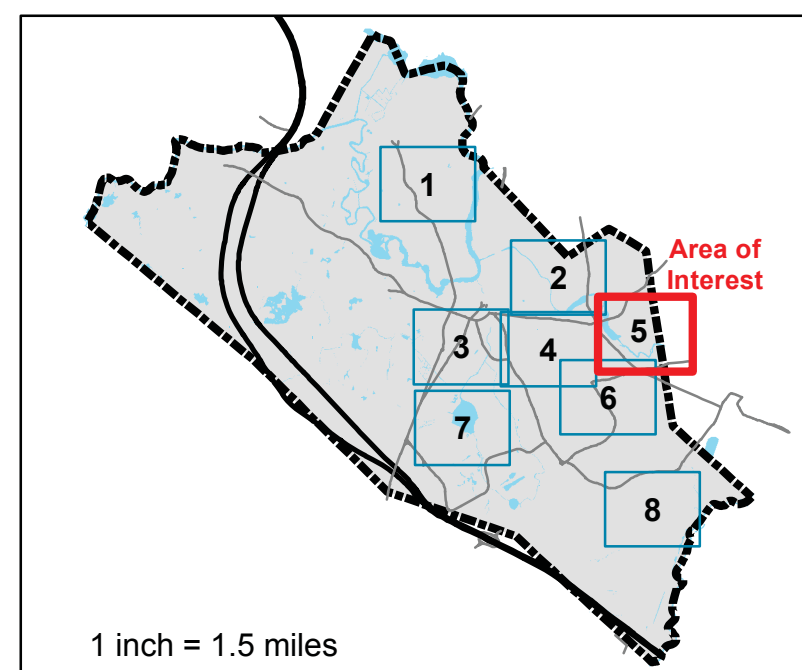

This document is intended for
Town of Dedham planning and
analysis purposes only.

Produced by:
The Town of Dedham
Engineering Department

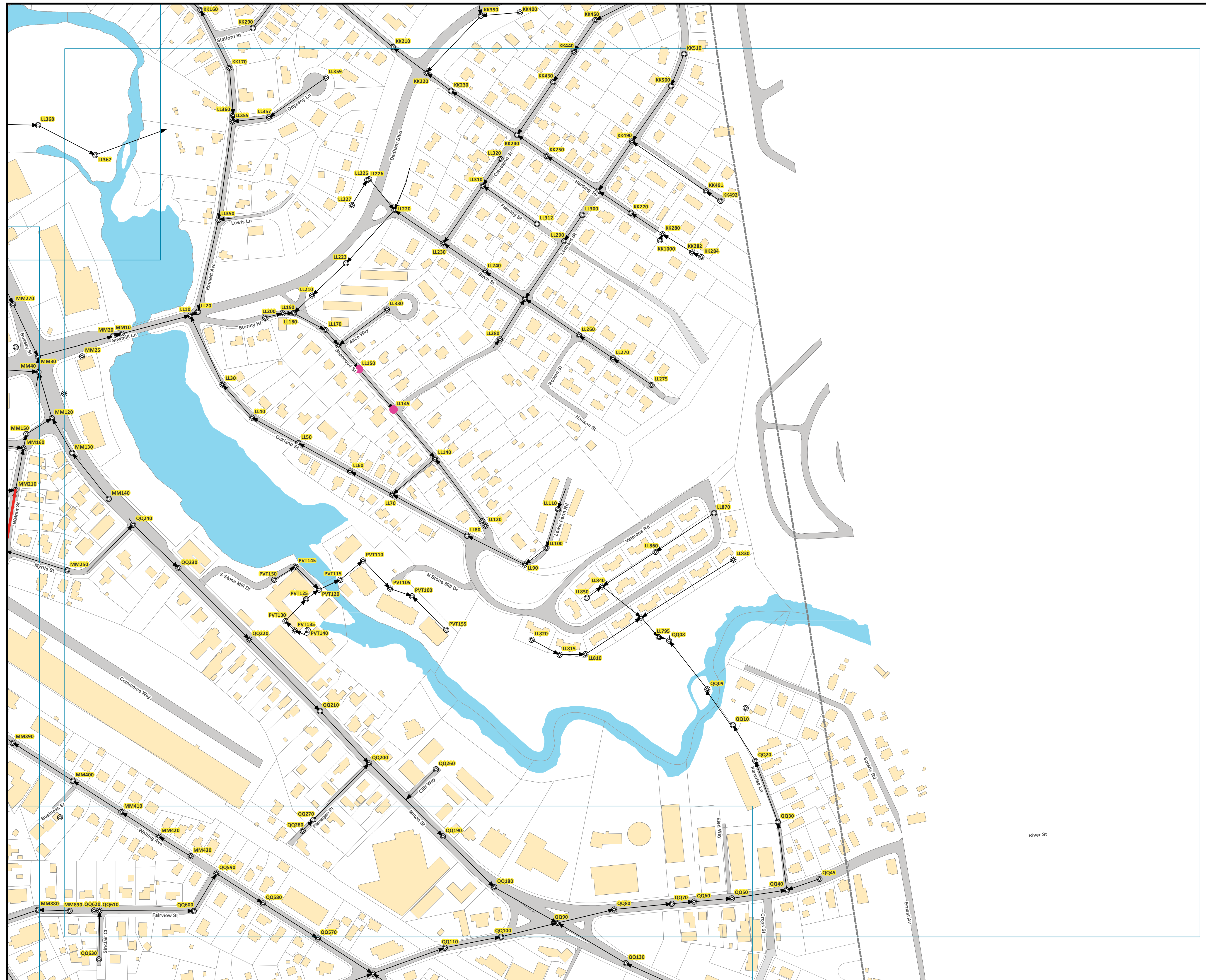

2021 Sewer Rehab Map

Map 6



TOWN OF DEDHAM
Norfolk County
Massachusetts

1 inch = 150 feet

Legend

Action

● Manhole Rehab

Action

— Cured in Place - Long Liner

— Cured in Place - Short Liner

⊙ Sewer Manholes

→ Sewer Pressurized Mains

→ Sewer Gravity Mains

— Sewer Stubs

Locus Map

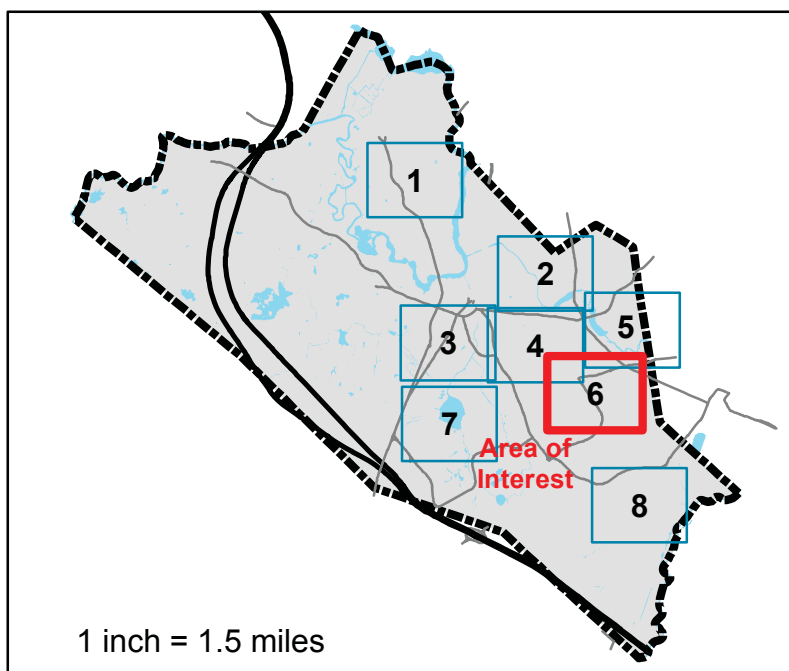

1 inch = 1.5 miles

This document is intended for
Town of Dedham planning and
analysis purposes only.

Produced by:
The Town of Dedham
Engineering Department

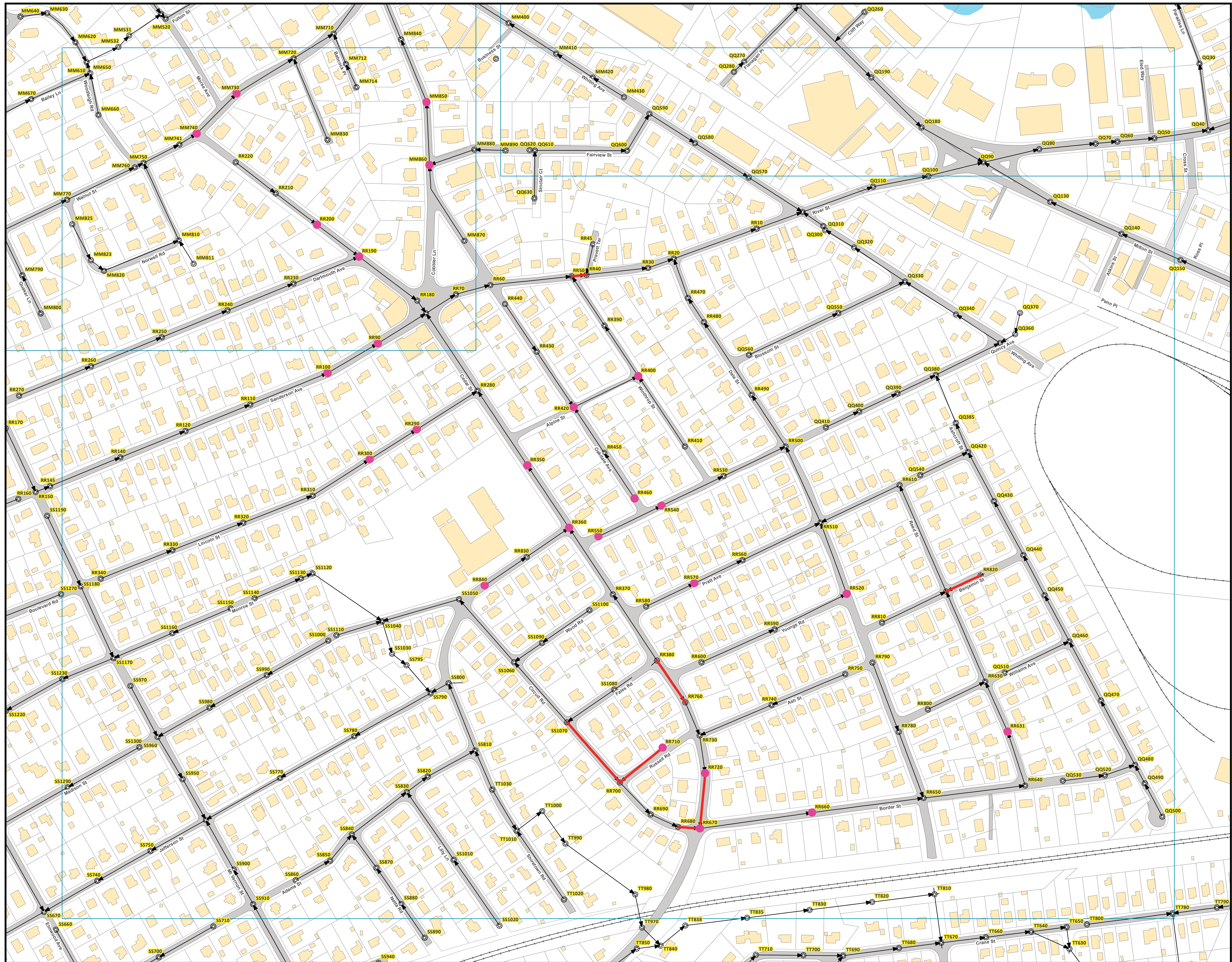

2021 Sewer Rehab Map

Map 7



TOWN OF DEDHAM
Norfolk County
Massachusetts

1 inch = 150 feet

Legend

- Action**
- Manhole Rehab
 - Cured in Place - Long Liner
 - Cured in Place - Short Liner
 - Sewer Manholes
 - Sewer Pressurized Mains
 - Sewer Gravity Mains
 - Sewer Stubs

Locus Map

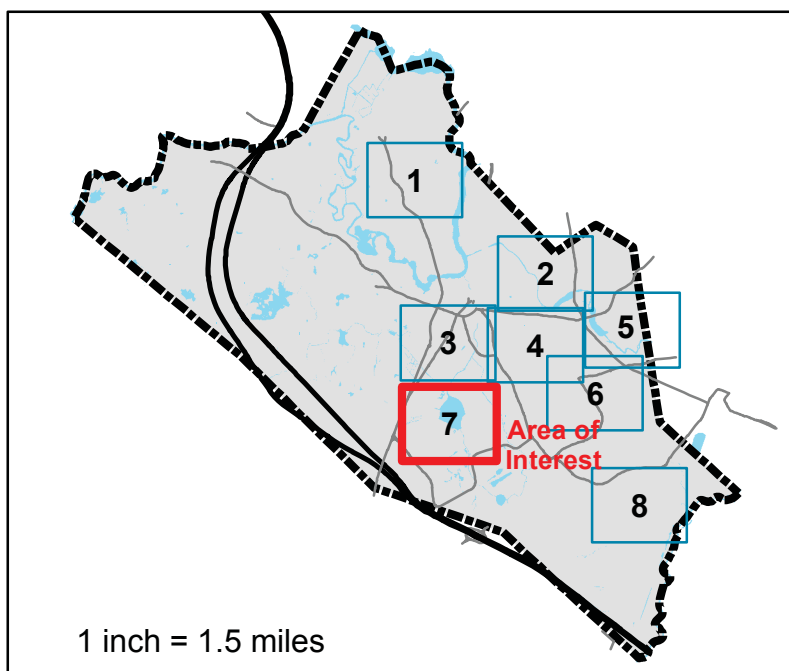

This document is intended for
Town of Dedham planning and
analysis purposes only.

Produced by:
The Town of Dedham
Engineering Department

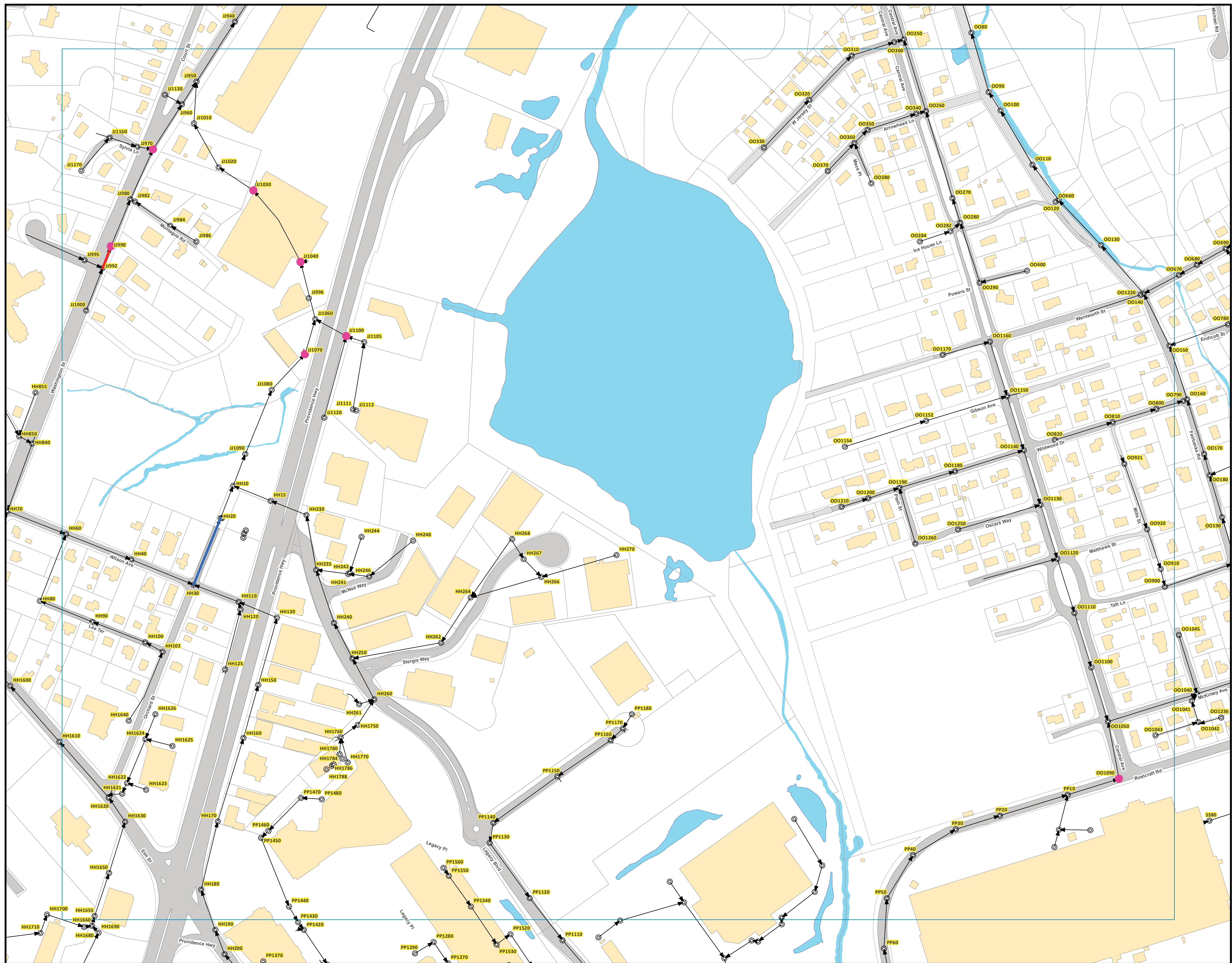

2021 Sewer Rehab Map

Map 8



TOWN OF DEDHAM
Norfolk County
Massachusetts

1 inch = 150 feet

Legend

Action

● Manhole Rehab

Action

— Cured in Place - Long Liner

— Cured in Place - Short Liner

⊙ Sewer Manholes

→ Sewer Pressurized Mains

→ Sewer Gravity Mains

— Sewer Stubs

Locus Map

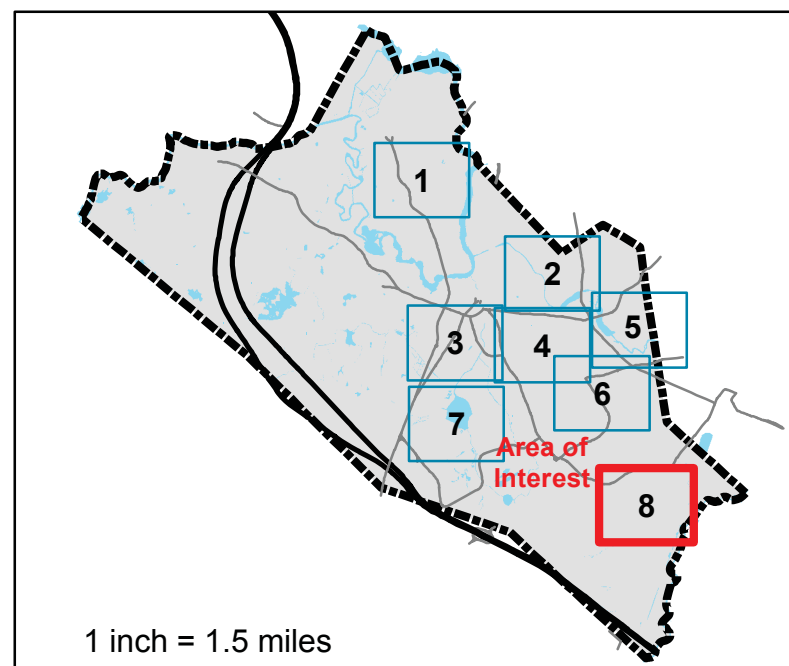

1 inch = 1.5 miles

This document is intended for
Town of Dedham planning and
analysis purposes only.

Produced by:
The Town of Dedham
Engineering Department

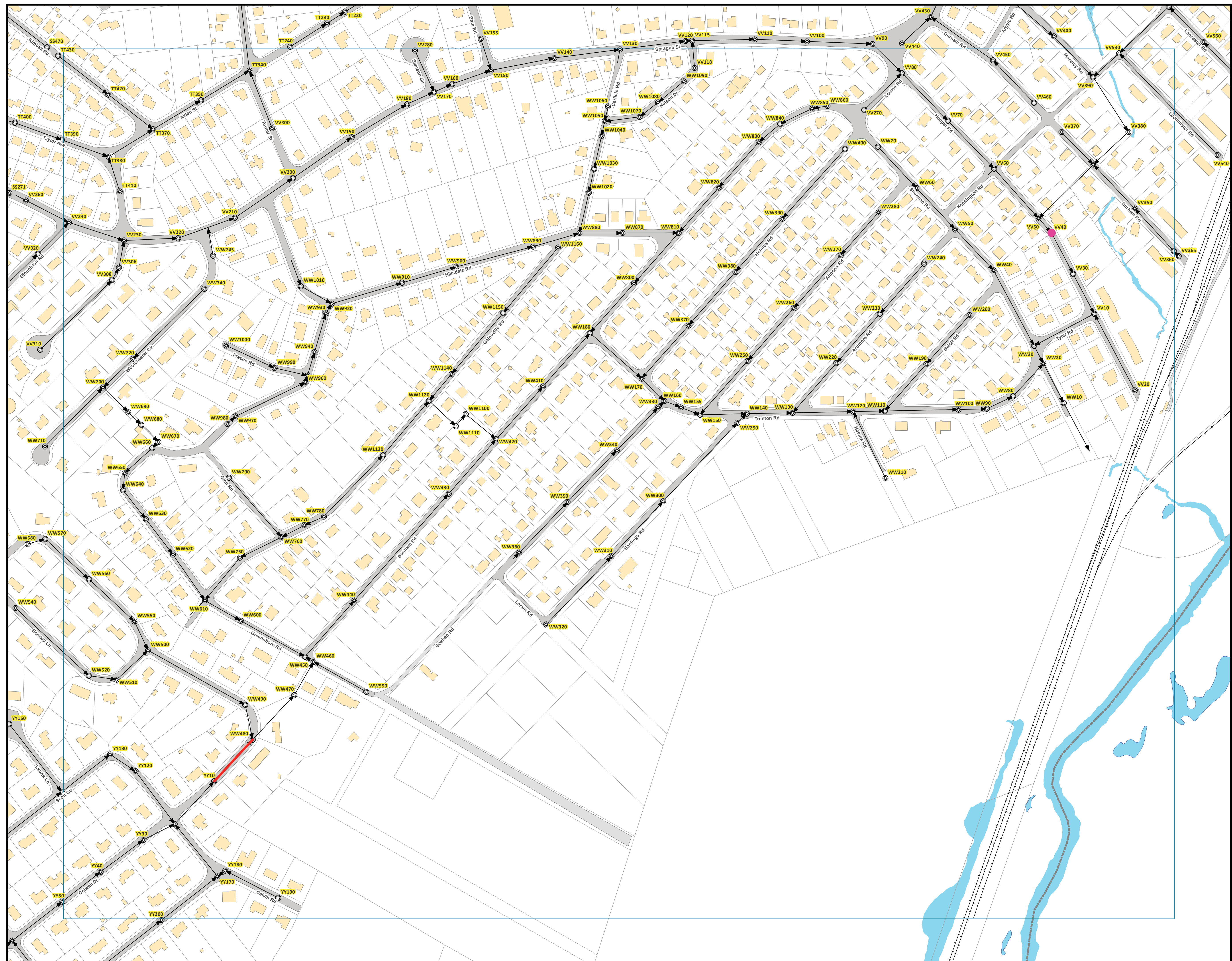

**2021 On-Call Services
Sewer Rehab Work Table
Cured-in-Place Liners**

PIPE ID	LOCATION	DIAMETER (in)	MATERIAL	TV LENGTH (ft)	CUT PROTUDING TAP	STATION	COMMENTS
DD160-DD120	Stivaletta Drive	8	VC	126			
DD200-DD190	Volk Road	8	PVC	216			PIPE IS PVC! Leaks at multiple joints and broken capped wye
JJ40-JJ30	High Steet	8	VC	239			
JJ290-JJ280	High Street	8	VC	300			
JJ300-JJ290	High Street	8	VC	185			
JJ320-JJ310	High Street	8	VC	70			
JJ330-JJ320	High Street	8	VC	160			
JJ508-JJ480	East Street	8	VC	14			
JJ50-JJ20	High Street	8	VC	211			
JJ520-JJ510	Avery Street	8	VC	242		0+48	Some concrete at a couple of joints
JJ780-JJ770	Willow Street	8	VC	326			
JJ80-JJ70	High Street	8	VC	115	1	1+12	
JJ810-JJ770	Willow Street	8	VC	129			
JJ870-JJ865	Washington Street	8	VC	58			
JJ880-JJ870	Washington Street	8	VC	244			
JJ992-JJ990	Washington Street	8	VC	79			
LL580-LL570	Bussey Street	8	VC	175			
MM220-MM210	Walnut Street	12	LVC	212			NEED TO DYE TEST 35 WALNUT W/ CAMERA IN PIPE TO LOCATE ACTIVE TAP. Re-lining to eliminate inactive taps
MM230-MM220	Walnut Street	12	LVC	219			NEED TO DYE TEST 28 MYRTLE W/ CAMERA IN PIPE TO LOCATE ACTIVE TAP. Re-lining to eliminate inactive taps
RR380-RR760	Cedar Street	8	VC	184	1	1+65	
RR50-RR40	River Street	8	VC	52			Has bulging short liner
RR680-RR670	Circuit Road	8	VC	78	1	0+15	
RR710-RR700	Russell Road	8	VC	194			
RR720-RR670	Cedar Street	8	VC	193			Has concrete in one joint
RR820-RR620	Benjamin Street	8	VC	126			Staining at joints
SS1070-RR700	Circuit Road	8	VC	281	2	1+13, 2+42	Staining at multiple joints
YY10-WW480	Colwell Drive	12	VC	200			

**2021 On-Call Services
Sewer Rehab Contract Work Table
Cured-in-Place Short Liners**

PIPE ID	LOCATION	DIAMETER (in)	MATERIAL	TV LENGTH (ft)	SERVICE REINSTATEMENT	STATION	SHORT LINER STATION	SHORT LINER LENGTH (ft)	COMMENTS
EE280-EE270	Berkeley Road	8	LVC	212	NO!		0+92 to 0+95	3	Reinstated tap that was previously capped at top of chimney
EE290-EE280	Berkeley Road	8	LVC	215	NO!		0+08 to 0+11	3	Leaking capped wye
GG70-GG50	Highland St Easement	12	LVC	284			0+65.5 to 0+68.5	3	Seam appears to be bulging due to water pressure. May need to do during dry weather
HH30-HH20	Dedham Sewers Cross Line	12	LVC	253	NO!		1+09 to 1+12	3	Reinstated tap that was previously capped at top of chimney

2021 On-Call Services				
Sewer Rehab Contract Work Table				
Sewer Manhole Rehabilitation				
MANHOLE ID	LOCATION	DEPTH (FT)	WALL MATERIAL	COMMENT
DD110	VIOLET AVENUE	9.9	BRICK	
DD160	STIVALETTA DRIVE	11.8	LINED	
DD190	VOLK ROAD	5.5	BRICK	
DD200	VOLK ROAD	6.1	LINED	
DD210	STIVALETTA DRIVE	6.7	LINED	
DD510	VIOLET AVENUE	11	LINED	
DD520	VIOLET AVENUE	8.6	CEMENT LINED	Stub from northeast is leaking and needs to be completely sealed off.
DD560	HILLCREST AVENUE	5.7	LINED	
DD570	KIELY ROAD	7.8	LINED	
DD600	ZOAR AVENUE	6.6	LINED	
DD620	ZOAR AVENUE	6.1	LINED	
DD660	ARCADIA AVENUE	4.4	LINED	
JJ1030	WASHINGTON STREET EASEMENT	12.4	LINED	
JJ1040	PROVIDENCE HIGHWAY EASEMENT	11.4	LINED	
JJ1070	PROVIDENCE HIGHWAY EASEMENT	9.3	LINED	
JJ1100	PROVIDENCE HIGHWAY	8.9	LINED	
JJ200	O'NEIL DRIVE EASEMENT	18.1	BRICK	
JJ230	ALLEN LANE	19.6	LINED	
JJ512	EAST STREET	11.2	PRECAST	
JJ580	WIGWAM BROOK LINE	11.9	CEMENT LINED	Leaking through liner in the trough
JJ630	EASTERN AVENUE	11.3	PRECAST	
JJ670	EASTERN AVENUE EASEMENT	11.8	PRECAST	
JJ680	EASTERN AVENUE	10.4	LINED	
JJ703	PROVIDENCE HIGHWAY EASEMENT	15.6	PRECAST	
JJ704	WIGWAM BROOK LINE	13.8	CEMENT LINED	Need to bypass pump and build invert
JJ710	BOSTON-PROVIDENCE HIGHWAY	13.4	LINED	
JJ770	WILLOW STREET	11.1	LINED	
JJ865	WASHINGTON STREET	9.8	CEMENT LINED	Leaking at pipe penetrations
JJ920	WASHINGTON STREET	11.2	Brick	
JJ970	WASHINGTON STREET	11.4	CEMENT LINED	NEEDS NEW TROUGH - Gaping hole in bench underneath pipe at 3 o'clock
JJ990	WASHINGTON STREET	11.8	BRICK	
KK10	COLBURN STREET	7	CEMENT LINED	Heavy leak at bench
LL145	SHERWOOD STREET	8.1	CEMENT LINED	Leaking at LL145-LL140 pipe 12 o'clock, right where liner comes into manhole.
LL150	SHERWOOD STREET	8.7	CEMENT LINED	Leaking at pipe penetrations
LL580	BUSSEY STREET	10.4	CEMENT LINED	Trough and pipe penetrations
MM350	HAZELNUT PLACE	10.1	BRICK	
MM360	CASS AVENUE	9.5	BRICK	
MM370	WHITING AVENUE	15	CEMENT LINED	Leak at step
MM730	WALNUT STREET	11.1	BRICK	
MM740	WALNUT STREET	9.5	BRICK	
MM850	OAKDALE AVENUE	7.8	BRICK	
MM860	OAKDALE AVENUE	7.8	LINED	
OO1090	RUSTCRAFT ROAD	15.4	BRICK	Added back to list b/c MWRA water main project
RR100	SANDERSON AVENUE	8.8	BRICK	Staining up and over trough
RR190	CEDAR STREET	7.3	BRICK	
RR200	CEDAR STREET	7.7	LINED	
RR290	LINCOLN STREET	6.6	PRECAST	
RR300	LINCOLN STREET	11	PRECAST	
RR350	CEDAR STREET	7.2	BRICK	
RR360	CEDAR AND MADISON	7.5	CEMENT LINED	Leak around pipe liner
RR400	WINTHROP STREET	8.9	CEMENT LINED	Leaking at pipe connection(s)
RR420	OAKDALE AND PINE	7.1	CEMENT LINED	Need to completely seal off stub from the southwest. The cap is leaking.
RR460	OAKDALE AVENUE	6.9	BRICK	
RR520	DALE STREET	10.5	PRECAST	
RR540	QUINCY AVENUE	10.3	BRICK	
RR550	QUINCY AVENUE	8.1	BRICK	
RR570	PRATT AVENUE	7.6	LINED	

MANHOLE ID	LOCATION	DEPTH (FT)	WALL MATERIAL	COMMENT
RR631	REED STREET	14.1	LINED	
RR660	BORDER STREET	6	BRICK	
RR670	CEDAR STREET	10.5	BRICK	NEEDS NEW TROUGH
RR710	RUSSELL ROAD	8.9	PRECAST	Leak at bottom of trough exiting manhole
RR720	CEDAR STREET	11.7	BRICK	
RR840	MADISON STREET	7.4	BRICK	
RR90	SANDERSON AVENUE	7.9	BRICK	
VV40	HOOPER ROAD	11.2	CEMENT LINED	Gusher in trough

PRECAST:

GROUT PORT (TYP) FOR EXTERIOR CHEMICAL SEALING OF MANHOLES. GROUT PORTS SHALL BE LOCATED EVERY 2 FEET (MAXIMUM) AROUND THE CIRCUMFERENCE OF THE MANHOLE, APPROXIMATELY ONE FOOT BELOW AND ONE FOOT ABOVE EACH JOINT TO SEAL ALL JOINTS. ADDITIONAL GROUT PORTS SHALL BE LOCATED SO AS TO SEAL ANY OTHER DEFECTS NOT OCCURRING AT A JOINT.

FOR BRICK/BLOCK MHS:

GROUT PORT (TYP) FOR EXTERIOR CHEMICAL SEALING OF MANHOLES. GROUT PORTS SHALL BE LOCATED AND DRILLED AROUND THE CIRCUMFERENCE OF THE MANHOLE TO ENSURE PROPER GROUTING OF THE SOIL OUTSIDE OF MANHOLE.

INTERIOR CEMENTITIOUS LINING SHALL BE APPLIED TO THE MANHOLE BENCH, WALLS AND CORBEL/CONE (TYP). A UNIFORM MONOLITHIC LINING OF 1/2 INCH MINIMUM SHALL BE APPLIED.

INTERIOR CEMENTITIOUS LINING SHALL BE APPLIED 3 INCHES INTO EACH SERVICE CONNECTION

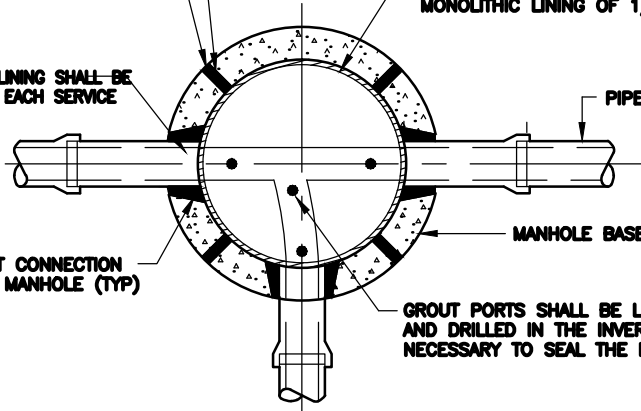

GROUT INJECTION AT CONNECTION BETWEEN PIPE AND MANHOLE (TYP)

GROUT PORTS SHALL BE LOCATED AND DRILLED IN THE INVERT AS NECESSARY TO SEAL THE INVERT

MANHOLE REHABILITATION PLAN

N.T.S.

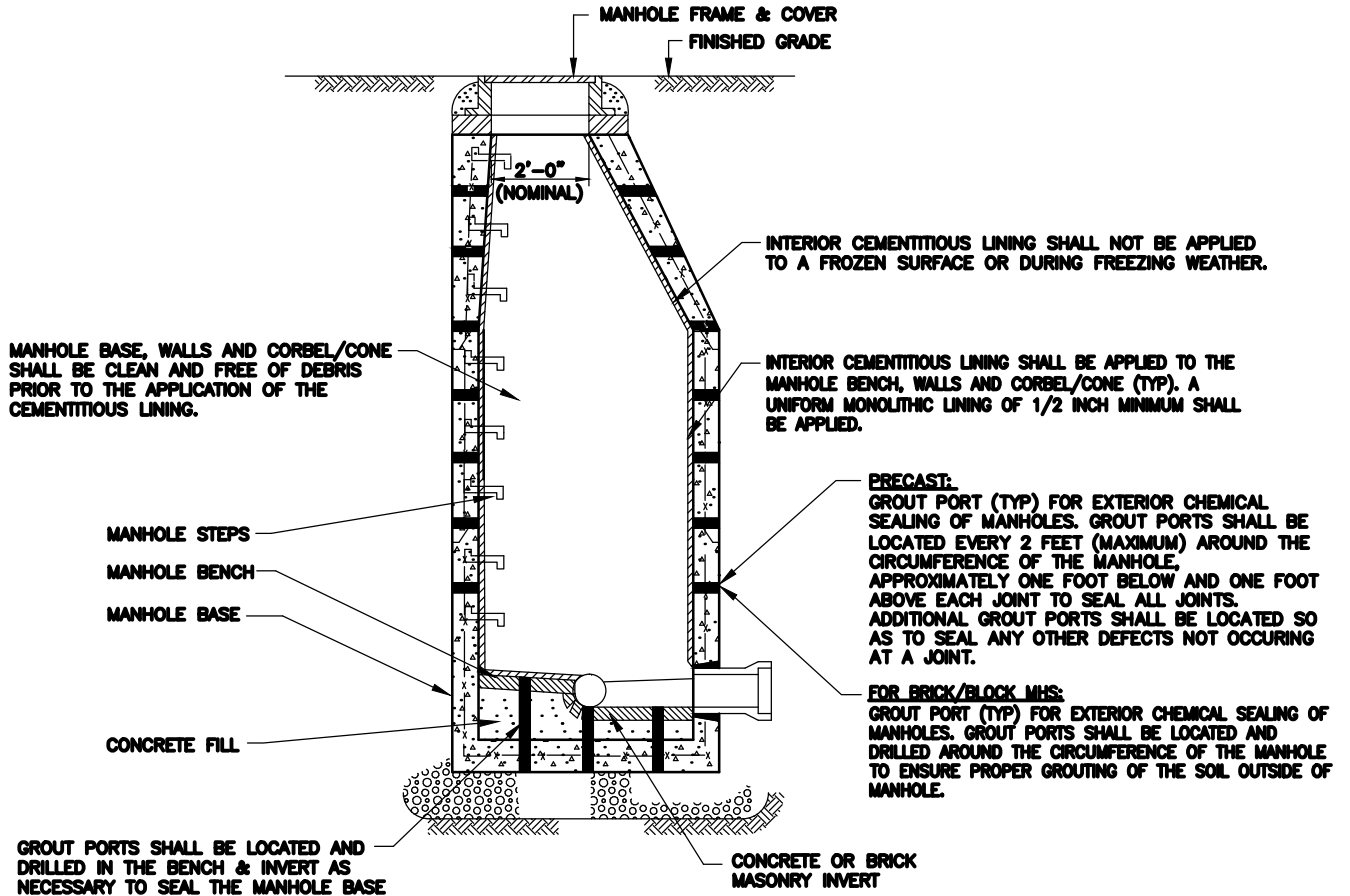

MANHOLE REHABILITATION DETAIL